

Technical Component Requirement Specifications

Tail lamp

Model series: X244/248

Sourcing Scope: VU150363-01

Date printed: 2022-07-25
Version: TM CompSpec (GC) STM BL V6.9.4 R20.9

Mercedes-Benz - Confidential -	<small>Schutzvermerk DIN ISO 16016 beachten! / Refer to protection notice DIN ISO 16016! Keine Aenderung ohne Zustimmung der federfuehrenden Konstruktion / Any alterations are subject to the approval of the design department</small> Technical Component Requirement Specifications Tail lamp QEV 111 AJPNLG	Bearb./auth.: Hans Peter Schiffert Abt./dep.: RD/KEL Datum/date: 2022-07-25 Requirement Specifications 001 version: Seite/page: 1 of 220
---	--	---

Approval

Department/function	Name
Author of component requirement specifications	Schiffert, Hans Peter
Level 4 Design	Hoffmann, Harry
Level 4 Electronics, Illumination Engineering, Testing	Günther, Michael
Level 4 Validation	Mertens, Jens
Department E3	Kostanzer, Uwe
Project Management, Model Series Development	Zolke, Oliver

<p>Mercedes-Benz - Confidential -</p>	<p><small>Schutzvermerk DIN ISO 16016 beachten! / Refer to protection notice DIN ISO 16016! Keine Änderung ohne Zustimmung der federführenden Konstruktion / Any alterations are subject to the approval of the design department</small></p> <p>Technical Component Requirement Specifications Tail lamp</p> <p>QEV 111 AJPNLG</p>	<p>Bearb./auth.: Hans Peter Schiffert Abt./dep.: RD/KEL Datum/date: 2022-07-25 Requirement Specifications 001 version: Seite/page: 2 of 220</p>
---	---	---

Modification Documentation for the Requirement Specifications History

Requirement Specifications version	Description of revision	Author	(Date)
002			
003			
004			
005			
006			
007			
008			
009			
010			
011			
012			
013			
014			
015			

Explanation of formatting used:

- *Italics: The text is information*
- *Standard font: The text is a requirement*

<p>Mercedes-Benz - Confidential -</p>	<p><small>Schutzvermerk DIN ISO 16016 beachten! / Refer to protection notice DIN ISO 16016! Keine Aenderung ohne Zustimmung der federfuehrenden Konstruktion / Any alterations are subject to the approval of the design department</small></p> <p>Technical Component Requirement Specifications Tail lamp QEV 111 AJPNLG</p>	<p>Bearb./auth.: Hans Peter Schiffert Abt./dep.: RD/KEL Datum/date: 2022-07-25 Requirement Specifications version: 001 Seite/page: 3 of 220</p>
---	---	--

Contents

1	Introduction (STM-867451)	13
1.1	Document Landscape (STM-867449)	13
1.1.1	Document Creation (STM-867456)	13
1.1.2	Common Requirements (STM-867455)	13
1.1.3	Logistics Component Requirement Specifications (STM-867465)	14
1.1.4	Excerpt from the Process Master Plan for Suppliers (STM-867463)	14
1.1.5	Other Documents Pertaining to These Requirement Specifications (STM-867468)	14
1.2	General Specifications (STM-867476)	15
2	Scope of Supply and Services (STM-867493)	18
2.1	Component-Specific Requirements (STM-867946)	18
2.1.1	Short Description and Development Scope (STM-867945)	18
2.1.2	Project Specifications (STM-867948)	18
2.1.2.1	Assignment of the Component to the Vehicle/Engine Model Series (STM-867952)	18
2.1.2.1.1	Assignment (STM-867950)	18
2.1.2.1.2	Market Launch (STM-867951)	18
2.1.2.2	Part ID Number (STM-867959)	18
2.1.2.3	Variants to Be Offered (STM-867956)	19
2.1.2.4	Installation Location in the Vehicle (STM-867958)	19
2.1.2.5	Supplier development costs engineering (LEK-E) payment plan (STM-2912031)	19
2.1.3	System Context (STM-867962)	19
2.1.4	Functions (STM-867960)	19
2.1.4.1	Basic Driving Functions (STM-868024)	19
2.1.5	Properties (STM-868051)	20
2.1.5.1	Target Weight Specification (STM-868050)	20
2.1.5.2	Corrosion Protection (STM-868056)	20
2.1.5.3	Material Selection/Material Specification (STM-868055)	20
2.1.5.3.1	Alternative Materials (STM-868064)	20
2.1.5.4	Tolerance Requirements (STM-868070)	20
2.1.5.5	Component Identification (STM-868074)	21
2.1.6	Interfaces (STM-868075)	21
2.1.6.1	Mechanical Interfaces (Fixation Concept) (STM-868082)	21
2.1.7	Mechanical Requirements for the Light (2123046)	21
2.1.7.1	General (2123050)	21
2.1.7.2	Overview of Variants (2123059)	22
2.1.8	Mechanical System Functions (2123113)	22
2.1.8.1	Day Design (2123114)	22
2.1.8.2	Night Design (2123141)	23
2.1.9	Mechanical System Properties (2123152)	23
2.1.9.1	Illuminants Used (General) (2123185)	23
2.1.9.2	Component-Specific Tolerance Data (2123207)	24
2.1.9.3	Material Selection/Material Specification (2123220)	25
2.1.9.4	Thermal Management (2123244)	25
2.1.10	Mechanical System Interfaces (2123297)	26
2.1.10.1	Overview of Mechanical System Interfaces (2123294)	26
2.1.10.2	Mechanical Loads (2123322)	26
2.1.10.3	Lamp Ventilation (2123334)	26
2.1.11	Component Design (2123340)	27
2.1.11.1	General Design Guidelines (2123348)	27
2.1.11.2	Alignment and Attachment (2123360)	27
2.1.11.2.1	General (2123359)	27
2.1.11.2.2	Cross Pin (2123368)	28

Mercedes-Benz - Confidential -	Schutzvermerk DIN ISO 16016 beachten! /Refer to protection notice DIN ISO 16016! Keine Aenderung ohne Zustimmung der federfuehrenden Konstruktion / Any alterations are subject to the approval of the design department	Technical Component Requirement Specifications Tail lamp	Bearb./auth.: Hans Peter Schiffert Abt./dep.: RD/KEL Datum/date: 2022-07-25 Requirement Specifications 001 version: Seite/page: 4 of 220
	QEV 111 AJPNLG		

2.1.11.2.3	Spacers / Min. Gap Limiters (2123370)	28
2.1.11.2.4	Preattachment of Lamp (2123390)	32
2.1.11.2.5	Fasteners (2123394)	32
2.1.11.2.5.1	General (2123397)	32
2.1.11.2.5.2	Adjustment Controls (2123405)	32
2.1.11.2.5.3	Double-Threaded Pin (2123413)	33
2.1.11.2.5.4	Threaded Pin with Flat Guide (Slide-In Stud) (2123416)	33
2.1.11.2.5.5	Clamping Claw (2123435)	33
2.1.11.3	Design Name Panel (2123452)	34
2.1.11.4	Off-Tool Design Name Panel (2753587)	34
2.1.11.5	Laser Design Name Panel (2753589)	35
2.1.11.6	Cover Lens (2123488)	35
2.1.11.7	Lamp Shroud (2123529)	37
2.1.11.7.1	General (2123526)	37
2.1.11.7.2	Lettering and Labels (2123590)	38
2.1.11.7.3	Connection for Bumper Bracket (2123619)	38
2.1.11.7.4	Color and Surface (2123622)	39
2.1.11.7.5	Molded-On Load Compartment-Side Shroud Panel (2123635)	39
2.1.11.8	Lamp Housing / Exterior Lamp Lens Connection (2123647)	40
2.1.11.9	Luggage Compartment Molding on the Lamp (2123664)	40
2.1.11.10	Additional Lamp Lenses / Optical Lenses (2123688)	43
2.1.11.11	Reflectors (Additional Reflectors) / Cover Frames (2123690)	43
2.1.11.12	Fiber-Optic Cables / Thick-Wall Optics (2123698)	43
2.1.11.13	Rear Reflectors / Side Reflectors (2123707)	44
2.1.11.14	Seals (2123710)	44
2.1.11.14.1	Sponge Rubber / Plate Seals (2123722)	45
2.1.11.14.2	TPE Ring Seal (2123727)	45
2.1.11.14.3	TPE Edge Seal (2123734)	46
2.1.11.15	LED PCBs (2123748)	46
2.1.11.16	Molding on Lamp (2123751)	47
2.1.11.17	Self-Adhesive Component Parts (2123762)	48
2.1.12	Mechanical System Testing and Validation (2123767)	48
2.1.12.1	In-Series Measurements (2123819)	48
2.1.12.2	CIP (2123837)	48
2.1.12.3	Certification/Homologation (2123840)	49
2.1.12.3.1	Time Frame (2123847)	49
2.1.13	Requirements Derived from the Electronics (2124736)	49
2.1.13.1	General (2124737)	49
2.1.13.1.1	Functional Safety (2124738)	49
2.1.13.1.2	E-E Coordination Document (2124744)	50
2.1.13.1.3	E-E Drawing Content (2124763)	50
2.1.13.1.4	Service Life (2124773)	51
2.1.13.2	Electronics Properties (2124777)	52
2.1.13.2.1	Contact System Features (2124776)	52
2.1.13.2.1.1	Mechanical/Design Features (2124783)	52
2.1.13.2.1.2	Contact Material Features (2124789)	52
2.1.13.2.1.3	Other Features (2124801)	52
2.1.13.2.2	Voltages and Currents (2124808)	53
2.1.13.2.2.1	Voltage Range (2124804)	53
2.1.13.2.2.2	Current Consumption (2124814)	54
2.1.13.2.2.3	Documentation of the Key Data and the Corresponding Documents (2124837)	54
2.1.13.2.2.4	In-Line Testing during Series Production (2124839)	55
2.1.13.2.3	Thermal Management (3220562)	55
2.1.13.2.4	Routing of Lines (2124846)	55
2.1.13.2.5	Printed Circuit Board (2124861)	56
2.1.13.2.6	Requirements for Electronic Component Parts (2124859)	56

Mercedes-Benz - Confidential -	Schutzvermerk DIN ISO 16016 beachten! / Refer to protection notice DIN ISO 16016! Keine Aenderung ohne Zustimmung der federfuehrenden Konstruktion / Any alterations are subject to the approval of the design department	Bearb./auth.: Hans Peter Schiffert Abt./dep.: RD/KEL Datum/date: 2022-07-25 Requirement Specifications 001 version: Seite/page: 5 of 220
	Technical Component Requirement Specifications Tail lamp QEV 111 AJPNLG	

2.1.13.2.7	General ESD Requirements (3229632)	57
2.1.13.3	Electronic System Interfaces (2124869)	57
2.1.13.3.1	Lamp/Vehicle Electrics Interface (Control Unit) (2124871)	57
2.1.13.4	Component Design (2124889)	58
2.1.13.4.1	Circuit Specifications - Integrated Tail Lamp Control (ITC) (2813892)	58
2.1.13.4.1.1	General (2872112)	58
2.1.13.4.1.2	Connection (2876783)	59
2.1.13.4.1.3	System Description (2872115)	60
2.1.13.4.1.4	Voltage Limitation/Voltage Regulation (2875300)	61
2.1.13.4.1.5	CAN (2887027)	63
2.1.13.4.1.6	LED Drivers (2888236)	65
2.1.13.4.1.7	LED-PCB Circuit (2896347)	66
2.1.13.4.1.8	BL Redundancy Line (3010442)	66
2.1.13.4.1.9	Behavior over Time (2896912)	67
2.1.13.4.1.10	Diagnosis (2904807)	68
2.1.13.4.1.11	GUI (Graphical User Interface) (2925315)	69
2.1.13.4.1.12	EMC (2945188)	69
2.1.13.4.1.13	Supplementary functional safety requirements for the ELC (exterior light control) (2951644)	70
2.1.13.4.1.14	Cooperation Model (2962184)	71
2.1.13.4.1.15	Actuation and Diagnosis (2964951)	71
2.1.14	Requirements Derived from Illumination Engineering (2141313)	72
2.1.14.1	General (2141311)	72
2.1.14.2	Deadlines and Project Procedure (2141323)	72
2.1.14.2.1	Physical Lamp Sample (2141331)	73
2.1.14.3	Simulations and Measurements (2141330)	73
2.1.14.4	Appearance Requirements (2141348)	74
2.1.14.4.1	Color Selection (2141350)	74
2.1.14.4.2	Homogeneity (2141356)	75
2.1.14.5	Function-Specific Requirements (2141376)	75
2.1.14.5.1	Tail Light Requirements (2141378)	75
2.1.14.5.1.1	Standing Light Requirements (2141382)	76
2.1.14.5.2	Brake Light Requirements (5095146)	76
2.1.14.5.3	Turn Indicator Requirements (2141380)	77
2.1.14.5.4	Back-up Light Requirements (2141386)	78
2.1.14.5.4.1	Color Selection (2141385)	78
2.1.14.5.4.2	Photometric Requirements (2141391)	79
2.1.14.5.5	Requirements for the Reflex / Side Reflex (3127941)	80
2.1.14.6	Camouflage (2141401)	80
2.1.15	Requirements from Testing (4056733)	80
2.1.15.1	General (4056734)	80
2.1.15.1.1	Deadlines and Project Procedure (4056742)	81
2.1.15.1.2	Test Documentation (4056746)	81
2.1.15.1.2.1	Documentation of Development Activities in DukE (4056993)	81
2.1.15.2	Conducting Tests (4056992)	82
2.1.15.2.1	General Specifications for Test Frames (4056994)	82
2.1.15.2.1.1	Specifications for the Environmental Test Frames (4056995)	83
2.1.15.2.1.2	Specifications for Test Frames for Photometric Tests (4056997)	84
2.1.15.2.1.3	Specifications for the Bracket (4086208)	85
2.1.15.2.2	Simulation of the Actuation of the Signal Lamps with PWM (4057001)	86
2.1.15.2.3	Function Classes (4057002)	87
2.1.15.2.4	Functional States (4057003)	87
2.1.15.2.5	Operating Modes (4057004)	87
2.1.15.2.6	Operating Modes (4057005)	87
2.1.15.2.7	Switching Profiles (4057006)	88
2.1.15.2.8	Key Parameters of Parameter Tests (4057007)	88

Mercedes-Benz - Confidential -	Schutzvermerk DIN ISO 16016 beachten! /Refer to protection notice DIN ISO 16016! Keine Aenderung ohne Zustimmung der federfuehrenden Konstruktion / Any alterations are subject to the approval of the design department	Bearb./auth.: Hans Peter Schiffert Abt./dep.: RD/KEL Datum/date: 2022-07-25 Requirement Specifications 001 version: Seite/page: 6 of 220
	Technical Component Requirement Specifications Tail lamp QEV 111 AJPNLG	

2.1.15.2.9	Continuous Parameter Monitoring (4058586)	89
2.1.15.2.10	Leaktightness (4086263)	89
2.1.15.2.11	Visual Inspection (4057008)	89
2.1.15.2.12	Physical Analysis (4057009)	89
2.1.15.3	Tests in accordance with MBN 10567 (4057010)	90
2.1.15.4	Tests in accordance with MBN 10384 (4084973)	91
2.1.15.5	Tests in accordance with MBN 10306 (4057016)	91
2.1.15.5.1	Deviating Test Scopes (4057022)	92
2.1.15.5.1.1	High-pressure Cleaning Test (4057023)	92
2.1.15.6	Additional Test Scopes (4057025)	93
2.1.15.6.1	Mechanical vibration test	93
2.1.15.6.2	Sound System Test (4057031)	94
2.1.15.6.3	Push Test (4057032)	95
2.1.15.6.4	Electrostatic discharge – Handling additional test (ESDH/Z test) (4057033)	96
2.1.15.6.5	Test for Sink Marks (4057035)	97
2.1.15.6.6	Ethanol Test (4057036)	97
2.1.15.6.7	Condensed Water Test for Metallized Components (4057037)	98
2.1.16	Sample and Delivery Dates (STLH-rm3-2785790)	98
2.1.16.1	Digital Warm Sample (STLH-rm3-2832920)	98
2.1.16.1.1	Software (STLH-rm3-2832945)	99
2.1.16.1.2	CAD Data (STLH-rm3-2832910)	99
2.1.16.1.3	Material Documentation and Material Definition (STLH-rm3-2832917)	99
2.1.16.1.4	Light Sources (STLH-rm3-2832921)	100
2.1.16.1.5	Sensors (STLH-rm3-2832946)	100
2.1.16.1.6	Simulation Parameters (STLH-rm3-2832925)	101
2.1.16.1.7	Results (STLH-rm3-2832923)	101
2.1.16.2	Specific Exterior Lighting Hardware Development Samples (STLH-rm3-2785789)	102
2.1.16.2.1	Partial Range Samples (STLH-rm3_3924482)	102
2.1.16.2.2	Warm Samples for DE-Freeze ABEL (STLH-rm3_3924539)	102
2.1.16.2.3	VDMF Warm Sample (STLH-rm3_3924605)	103
2.1.17	Tool Concept and Controlling (STLH-rm3-2785822)	103
2.1.18	General Requirements Pertaining to Injection-Molded Plastic Parts and Their Value Appeal (STLH-rm3-2785834)	104
2.1.19	Requirements as part of Offer Creation, Contract Award, and Change Management (STLH-rm3-2785856)	106
2.1.20	General (4266009)	107
2.1.20.1	Introduction (4266012)	107
2.1.20.2	Short Description of the System (4266015)	107
2.1.20.3	System Limits (4266018)	108
2.1.20.4	Assignment of the System to Vehicle or Engine Model Series (4266021)	108
2.1.20.5	Contacts (4266025)	109
2.1.20.5.1	Contacts for the Overall System (4266027)	109
2.1.20.5.2	Contacts for Adjacent Systems (4266028)	109
2.1.20.5.3	Contacts for Components of the System (4266031)	109
2.1.20.6	Change Management (4266029)	109
2.1.21	Requirements Pertaining to the System (4266037)	109
2.1.21.1	System Objectives (4266034)	109
2.1.21.2	Certification and Legal Constraints (4266035)	109
2.1.21.2.1	DS-Relevant Functions in the Exterior Lighting System (4266041)	110
2.1.21.3	Functional Safety (4266046)	110
2.1.21.3.1	System Functions Taken into Account as Part of the Hazard Analysis and Risk Assessment (4266045)	110
2.1.21.3.2	Safety Objectives from the Hazard Analysis and Risk Assessment (4266050)	110
2.1.21.3.3	Safety Requirements (4266074)	112
2.1.21.4	Customer Functions (4266082)	112
2.1.21.4.1	Basic Driving Functions (4266138)	115

Mercedes-Benz - Confidential -	<small>Schutzmerk DIN ISO 16016 beachten! / Refer to protection notice DIN ISO 16016! Keine Aenderung ohne Zustimmung der federfuehrenden Konstruktion / Any alterations are subject to the approval of the design department</small>	Technical Component Requirement Specifications Tail lamp	Bearb./auth.: Hans Peter Schiffert Abt./dep.: RD/KEL Datum/date: 2022-07-25 Requirement Specifications 001 version: Seite/page: 7 of 220
	QEV 111 AJPNLG		

2.1.21.4.1.1	Short Description (4266137)	115
2.1.21.4.1.2	Use Cases (4266139)	115
2.1.21.4.1.3	Functional Requirements (4266143)	115
2.1.21.4.1.4	Functional Architecture (4266142)	115
2.1.21.4.2	Extended Functions (4266145)	116
2.1.21.4.2.1	Short Description (4266148)	116
2.1.21.4.2.2	Use Cases (4266149)	116
2.1.21.4.2.3	Functional Requirements (4266153)	116
2.1.21.4.2.4	Functional Architecture (4266152)	116
2.1.21.4.3	Service Provider System Function (API Interface) (4266157)	117
2.1.21.4.3.1	Short Description (4266155)	117
2.1.21.4.3.2	Use Cases (4266162)	117
2.1.21.4.3.3	Functional Requirements (4266166)	117
2.1.21.4.3.4	Functional Architecture (4266167)	117
2.1.21.5	Function Description of System Functions (4266169)	118
2.1.21.5.1	ITC Short Description of the Software Functions (Calculation and Actuation) (4266170)	118
2.1.21.5.1.1	Overview (4266171)	118
2.1.21.5.1.2	LMRA Functions (4266174)	118
2.1.21.5.1.3	LPSR Functions (4266178)	120
2.1.21.5.1.4	Abbreviations and Terms and Definitions (4266179)	121
2.1.21.6	Cross-Functional Requirements Pertaining to the System (4266182)	122
2.1.21.6.1	Security (4266183)	122
2.1.21.6.1.1	Protection against Manipulation (4266187)	122
2.1.21.6.1.2	Software and Data Integrity, Confidentiality (4266192)	123
2.1.21.6.1.3	Data Transmission via Secure Channels (4266191)	123
2.1.21.6.1.4	Robustness (4266198)	123
2.1.21.6.1.5	Safe Storage (4266195)	123
2.1.22	Requirements Pertaining to Involved Systems (4266199)	123
2.1.22.1	Systems Involved (4266203)	123
2.1.23	Requirements Pertaining to Involved Components (4266200)	124
2.1.23.1	Diagram of the Involved Components (4266202)	124
2.1.23.2	Taillight Component (4266206)	125
2.1.23.2.1	Functional Safety Requirements (4266205)	125
2.1.23.2.1.1	Overview/Reference to Safety Objectives (4266207)	125
2.1.23.2.1.2	Stop Lamp (4266209)	125
2.1.23.2.1.3	Safety Requirements with Regard to Turn Signals (Failure) (4266224)	127
2.1.23.2.1.4	Safety Requirements with Regard to Turn Signals (Activation on the Wrong Side) (4266234)	128
2.1.23.2.1.5	Cross-Functional Safety Requirements (4266244)	129
2.1.23.2.2	ITC (Integrated Taillight Control) Requirements (4266252)	130
2.1.23.2.2.1	ITC Description (4266250)	130
2.1.23.2.2.2	Actuation of Light Functions (4266259)	131
2.1.23.2.2.3	Number of LED Channels/Number of LED Drivers Supported by SW (4266279)	132
2.1.23.2.2.4	Validation of ITC CAN Bus Physics (4266285)	133
2.1.23.2.2.5	Requirements for the Communication Interface (4266295)	134
2.1.23.2.2.6	Development/Production Status of the Taillight (4266302)	134
2.1.23.2.3	Hardware Requirements for the Taillight (4266304)	134
2.1.23.2.3.1	PWM Frequency for the Actuation of the LEDs (4266308)	134
2.1.23.2.3.2	Redundant Power Supply for the Taillight (4266307)	135
2.1.23.2.4	General Requirements (4266314)	135
2.1.23.2.4.1	On-Board Electrical System Requirements (4266317)	135
2.1.23.2.4.2	Latency Periods (4266321)	136
2.1.24	Annex (4266329)	136
2.1.24.1	Normative References (4266328)	136
2.1.25	Requirements for the Process (Process Requirement Specifications - PLH) (3120440)	136
2.1.25.1	Preventive Maturity Level Management (3120450)	137

Mercedes-Benz - Confidential -	Schutzvermerk DIN ISO 16016 beachten! /Refer to protection notice DIN ISO 16016! Keine Aenderung ohne Zustimmung der federfuehrenden Konstruktion / Any alterations are subject to the approval of the design department	Bearb./auth.: Hans Peter Schiffert Abt./dep.: RD/KEL Datum/date: 2022-07-25 Requirement Specifications 001 version: Seite/page: 8 of 220
	Technical Component Requirement Specifications Tail lamp QEV 111 AJPNLG	

2.1.25.1.1	Start of Preventive Maturity Level Management (3157542)	137
2.1.25.1.2	Scope (3157545)	137
2.1.25.1.3	Scheduling (3157549)	138
2.1.25.1.4	Documentation of Maturity Level Up to SOP (3157871)	139
2.1.25.1.5	Maturity Level Monitoring after the Start of Series Production (3157953)	140
2.1.25.2	Specific Production Process Requirements (3157961)	141
2.1.25.2.1	Requirements Pertaining to the Process Flow (3157962)	141
2.1.25.2.1.1	Implementation of the Procedure (3157963)	141
2.1.25.2.1.2	Scrap and Rework (3158079)	142
2.1.25.2.1.3	Testing Procedure, Testing Sequence, and Testing Frequency in the Process (3165793)	142
2.1.25.2.1.4	Component Part Geometry (3166456)	143
2.1.25.2.1.5	Fulfillment of the Legal and MB-Specific Requirements Regarding Illumination Engineering (3166536)	145
2.1.25.2.1.6	Cleanliness of the Component (3169665)	146
2.1.25.2.1.7	Storage, Material Flow, Continuous Production (3181279)	147
2.1.25.2.1.8	Machine Failure (3181287)	147
2.1.25.2.1.9	Identification and Traceability (3181290)	148
2.1.25.2.2	Requirements Pertaining to Human Resources (3181295)	148
2.1.25.2.3	Efficiency Requirements (3181299)	148
2.1.25.2.3.1	Process Parameters and Process Monitoring (3181300)	148
2.1.25.2.3.2	Capability Investigation (3181302)	148
2.1.25.2.3.3	Performance Test (3181304)	149
2.1.25.2.4	Machine Requirements (3181318)	150
2.1.25.2.4.1	Special Requirements Pertaining to the System (3181319)	150
2.1.25.2.4.2	Manufacturing Plant and Facilities (3181322)	151
2.1.25.2.4.3	Test Equipment and Calibration (3181325)	151
2.1.25.2.4.4	Maintenance (3181332)	151
2.1.25.2.4.5	Supports, Tooling, and Cleaning Agents (3181336)	152
2.2	Service Life and Reliability (STM-869019)	152
2.2.1	Reliability Validation in the Product Creation Process (STM-869028)	152
2.2.2	E/E Components (STM-869090)	153
2.2.2.1	Service Life of E/E Components (STM-869091)	153
2.2.2.1.1	Component-Specific Service Life Specification (STM-1207583)	153
2.2.2.2	Mission Profile (STM-869105)	153
2.2.2.2.1	Climatic Condition (STM-869107)	153
2.2.2.2.1.1	Operating Mode: Driving (STM-869104)	153
2.2.2.2.1.2	Operating Mode: Off-Grid Parking (STM-869157)	154
2.2.2.2.2	Protection against the Ingress of Solid Foreign Objects (Including Dust) (STM-869166)	154
2.2.2.2.3	Protection against the Ingress of Water/Fluids (STM-869174)	154
2.2.2.3	Environmental Testing for E/E Components (STM-869192)	155
2.2.2.3.1	General Test Parameters (STM-869189)	155
2.2.2.3.1.1	Test Parameter T_{min} (STM-1208014)	155
2.2.2.3.1.2	Test Parameter T_{RT} (STM-1208031)	155
2.2.2.3.1.3	Test Parameter T_{max} (STM-1208068)	155
2.2.2.3.1.4	Test Parameter $T_{op,min}$ (STM-1208099)	155
2.2.2.3.1.5	Test Parameter $T_{op,max}$ (STM-1208187)	155
2.2.2.3.1.6	Test Parameter U_{Bmin} (STM-1209128)	156
2.2.2.3.1.7	Test parameter U_B (STM-1212412)	156
2.2.2.3.1.8	Test Parameter U_{Bmax} (STM-1212415)	156
2.2.2.3.2	Operating Modes (STM-869228)	156
2.2.2.3.2.1	Operating Modes without Operating Load – The DUT is Not Connected to Electricity (STM-869230)	156
2.2.2.3.2.2	Operating Modes with Operating Load – The DUT is Connected to Electricity (STM-869236)	157
2.2.2.3.3	Parameter Test and Parameter Monitoring (STM-869248)	158

Mercedes-Benz - Confidential -	Schutzvermerk DIN ISO 16016 beachten! / Refer to protection notice DIN ISO 16016! Keine Aenderung ohne Zustimmung der federfuehrenden Konstruktion / Any alterations are subject to the approval of the design department	Bearb./auth.: Hans Peter Schiffert Abt./dep.: RD/KEL Datum/date: 2022-07-25 Requirement Specifications 001 version: Seite/page: 9 of 220
	Technical Component Requirement Specifications Tail lamp QEV 111 AJPNLG	

2.2.2.3.3.1	Parameter Test (STM-869247)	158
2.2.2.3.3.2	Continuous Parameter Monitoring with Drift Analysis (STM-869257)	159
2.2.2.3.3.3	Sampling Rates and Measured Value Resolutions (STM-869260)	159
2.2.2.3.3.4	Leak Test (STM-869261)	159
2.2.2.3.3.5	Physical Analysis (STM-869269)	160
2.2.2.3.4	Tests (STM-869270)	160
2.2.2.3.4.1	M-03 Dust Test (STM-869308)	161
2.2.2.3.4.2	M-04 Vibration Test (STM-869319)	162
2.2.2.3.4.3	M-05 Mechanical Shock (STM-869429)	163
2.2.2.3.4.4	M-06 Mechanical Shock Endurance (STM-869441)	164
2.2.2.3.4.5	K-01 High/Low Temperature Storage (STM-869466)	164
2.2.2.3.4.6	K-02 Multi-Stage Temperature Test (STM-869476)	165
2.2.2.3.4.7	K-03 Low-Temperature Operation (STM-869488)	166
2.2.2.3.4.8	K-05 Thermal Shock (Component) (STM-869507)	167
2.2.2.3.4.9	K-06 Salt Spray Test, Operating, Exterior (STM-869537)	167
2.2.2.3.4.10	K-08 Damp Heat, Cyclic (STM-869562)	168
2.2.2.3.4.11	K-09 Damp Heat, Cyclic (with Frost) (STM-869574)	169
2.2.2.3.4.12	K-10 Water Protection - IPX0 to IPX6K (STM-869585)	170
2.2.2.3.4.13	K-14 Damp Heat, Steady State (STM-869647)	170
2.2.2.3.4.14	K-16 Thermal Shock (without Shroud) (STM-869717)	171
2.2.2.3.4.15	K-18 Corrosion Test with Flow of Mixed Gas (STM-869743)	172
2.2.2.3.4.16	L-02 Life Test: High-Temperature Endurance Test (STM-869823)	172
2.2.2.3.4.17	L-03 Life Test: Temperature Cycle Endurance Test (STM-869887)	173
2.2.2.3.5	Test Sequence Plan (STM-869950)	176
2.2.2.3.5.1	Sequential Tests (STM-869949)	176
2.2.2.3.5.2	Tests outside the Sequence (Parallel Tests) (STM-869954)	177
2.2.2.3.5.3	Life Tests (STM-869957)	178
2.3	Electromagnetic Compatibility (EMC) (STM-867664)	178
2.3.1	General EMC Requirements (STM-867667)	178
2.3.2	Components with Bus Systems (CAN, LIN, FlexRay, Ethernet, etc.) (STM-867676)	179
2.3.3	ESD Requirements (STM-867674)	179
2.3.3.1	General (STM-867678)	179
2.3.3.2	Classification Regarding Electrostatic Sensitivity (STM-867680)	179
2.3.4	Test Conditions (STM-867685)	180
2.3.4.1	Operating States (STM-867686)	180
2.3.4.2	Test Criteria (STM-867689)	180
2.3.5	EMC Performance Requirements – Component Tests (STM-867695)	181
2.3.5.1	RF Emissions – Artificial Network Measurements (AN Test) (STM-867694)	181
2.3.5.2	RF Emissions – Antenna Measurements (RE Test) (STM-867696)	181
2.3.5.3	RF Emissions – Antenna Near-Field (NFA Test) (STM-867699)	181
2.3.5.4	Transient Emissions on Supply Lines (CTE Test) (STM-867713)	182
2.3.5.5	RF Immunity – Bulk Current Injection (BCI Test) (STM-867712)	182
2.3.5.6	RF Immunity: OPTION 1 – Antenna Irradiation (ALSE Test), OPTION 2 – Reverberation Chamber (CRC Test) (STM-867716)	182
2.3.5.7	Transients on Supply Lines (TSUP Test) (STM-867719)	182
2.3.5.8	Transients on Lines Other than Supply Lines (TOL Test) (STM-867727)	182
2.3.5.9	Electrostatic Discharge – Handling Test (ESDH Test) (STM-867728)	182
2.3.5.10	Electrostatic Discharge (Powered Up) – Direct Discharge (ESDD Test) (STM-867729)	183
2.3.5.11	Electrostatic Discharge (Powered Up) – Indirect Discharge (ESDI Test) (STM-867734)	183
2.3.6	EMC Performance Requirements – Vehicle Tests (STM-867739)	183
2.3.6.1	On-Vehicle Antenna Measurements (CISPR25 Test) (STM-867743)	183
2.3.6.2	Reference Receiver Measurement on Vehicle Antennas (REF Test) (STM-1235373)	183
2.3.6.3	Emission Measurement with Off-Board Antenna (CISPR12 Test) (STM-867747)	184
2.3.6.4	Magnetic Field Emission (MFE Test) (STM-867748)	184
2.3.6.5	Immunity; OPTION 1 – To Off-Vehicle Transmitters (OVRS Test); OPTION 2 – Test in the Reverberation Chamber (RC Test) (STM-867749)	184

Mercedes-Benz - Confidential -	<small>Schutzvermerk DIN ISO 16016 beachten! / Refer to protection notice DIN ISO 16016! Keine Aenderung ohne Zustimmung der federfuehrenden Konstruktion / Any alterations are subject to the approval of the design department</small>	Bearb./auth.: Hans Peter Schiffert Abt./dep.: RD/KEL Datum/date: 2022-07-25 Requirement Specifications 001 version: Seite/page: 10 of 220
	Technical Component Requirement Specifications Tail lamp QEV 111 AJPNLG	

2.3.6.6	Immunity to Transmitters Installed in the Vehicle by the Customer (OBT Test) (STM-867755)	184
2.3.6.7	Immunity to Permanently Installed In-Vehicle Transmitters (OBT2 Test) (STM-867757)	184
2.3.6.8	Immunity to Portable Transmitters (PT Test) (STM-867759)	185
2.3.6.9	Electrostatic Discharges (ESD Test) (STM-867764)	185
2.4	General E/E Requirements (STM-868102)	185
2.4.1	E/E Properties (STM-868101)	185
2.4.1.1	Electrical Requirements (STM-868105)	185
2.4.1.1.1	12 V On-Board Electrical System Requirements (STM-868104)	185
2.4.2	E/E Interfaces (STM-868203)	186
2.4.2.1	Electrical Interfaces (STM-868201)	186
2.4.2.2	General Connection Requirements (STM-868207)	186
2.4.2.3	Communications Interfaces (STM-868221)	187
2.4.2.3.1	Operational Reliability in the Event of Communications Failure (STM-1207555)	187
2.4.3	E/E Component Elements (STM-868250)	187
2.4.3.1	Component Element Selection (STM-868249)	187
2.4.3.2	Risk Component Elements (STM-868251)	188
2.4.3.3	Selection of Semiconductors (STM-868256)	188
2.4.3.4	Semiconductor Component Elements for FlexRay, CAN, LIN and Ethernet (STM-868261)	188
2.4.3.5	Rare Earths (STM-868271)	188
2.4.3.6	Printed Circuit Boards (STM-868273)	189
2.4.4	E/E Design Rules and Lessons Learned (STM-868278)	189
2.4.5	E/E Processes (STM-868292)	189
2.4.5.1	Delta Certification (STM-1236720)	189
2.4.6	E/E Data (STM-868301)	189
2.4.7	E/E Documentation (STM-868306)	190
2.5	Fire Prevention Criteria (STM-867313)	191
2.5.1	Electrics/Electronics (STM-867321)	191
2.5.1.1	Wiring Harness (STM-867320)	191
2.5.1.1.1	Basic Rules on Routing Electrical Lines in Vehicles (STM-867326)	191
2.5.1.1.2	Insulation (STM-867336)	192
2.5.1.1.3	Plug Connections / Connecting Points of Distributor Rails (STM-867337)	192
2.6	Assembly (STM-867504)	192
2.7	Shelf Life, Packaging and Transportation (STM-867505)	193
2.8	After-Sales (STM-867511)	193
3	Contacts and Responsibilities (STM-867520)	195
3.1	Client's Contacts (STM-867521)	195
3.2	Project Responsibilities (STM-867533)	196
3.3	Requirements Pertaining to Development-Related Services (STM-867548)	199
3.4	Protection Requirements When Handling Vehicles and/or Components Before the Press Announcement Day (PAD) (STM-2855915)	200
4	Deadlines, Tools and Components in the Development Process (STM-867573)	201
4.1	Data Provision and Release Deadlines for Documentation Maturity Levels (STM-867577)	201
4.2	Tools and Components in the Development Process (RD Requirements) (STM-867583)	201
4.2.1	General Requirements (STM-867587)	201
4.2.2	Tool Concept and Controlling (2831619)	202
4.2.3	Delimitation of Sample Parts (STM-867593)	202
4.2.4	Sample Parts in the Development Process (STM-867597)	203
4.2.4.1	Sample and Delivery Dates (2831621)	203
4.2.4.2	Tool Specification for Sample Parts (STM-867598)	203
4.2.4.3	Sourcing of Prototype Tools and Sample Parts (STM-867603)	204
4.2.4.4	Pricing of Sample Parts (STM-867612)	204
4.2.4.5	Quantities for Components (STM-867613)	205
4.2.5	PPA Sampling (STM-867618)	205
4.3	E/E Maturity Level Management (STM-2100431)	206

Mercedes-Benz - Confidential -	<small>Schutzvermerk DIN ISO 16016 beachten! / Refer to protection notice DIN ISO 16016! Keine Aenderung ohne Zustimmung der federfuehrenden Konstruktion / Any alterations are subject to the approval of the design department</small>	Technical Component Requirement Specifications Tail lamp	Bearb./auth.: Hans Peter Schiffert Abt./dep.: RD/KEL Datum/date: 2022-07-25 Requirement Specifications 001 version: Seite/page: 11 of 220
	QE V 111 AJP N L G		

5	Documentation (STM-867623)	207
5.1	Special Features (Part 1) – Safety-Relevant Features (DS) (STM-867628)	207
5.2	Special Features (Part 2) – Certification-Relevant Characteristics (DZ) (STM-2100464)	207
5.2.1	Implementation of Certification Relevant Characteristics (STM-2100466)	207
5.3	Vehicle Documentation in VeDoc for Passenger Cars (STM-867645)	211
5.4	CAD product data and prerequisites for the IT connection (STM-867387)	211
5.4.1	NX Data Format (STM-867388)	212
5.4.1.1	Generation of Data (STM-867392)	212
5.4.1.2	Prescribed Design Methodology (STM-867393)	212
5.4.1.3	Scope of Data to Be Delivered (STM-867394)	212
5.4.1.4	Datum System of the CAD Models (STM-867406)	212
5.4.2	JT and TIFF Data Format (STM-867409)	212
5.4.2.1	Prescribed Preparation Methodology (STM-867411)	212
5.4.2.2	Scope of Data to Be Delivered (STM-867412)	212
5.4.2.3	Datum System of the CAD Models (STM-867420)	213
5.4.3	Provided Installation Space Environment (STM-867422)	213
5.4.4	CAD Qualification (STM-867423)	213
5.4.5	Prerequisites for IT Integration (STM-867431)	213
5.4.5.1	Qualification (STM-2100588)	213
5.4.5.2	Contractual regulations and need for protection (STM-867436)	214
5.4.5.3	Network Connection to the Client's IT Network (STM-867438)	214
5.4.5.4	Reporting Users to Be Deployed (STM-867441)	214
5.4.5.5	Reference Points for Better Evaluation of the Requirements Described Above (STM-2100946)	215
5.5	Documentation of Material and Surface Selection (STM-2102104)	215
5.6	Digital Development (STM-867648)	215
6	Supplementary Specifications (STM-867651)	216
7	List of Abbreviations (STM-867656)	217
8	Normative References (STM-867662)	218

<p>Mercedes-Benz</p> <p>- Confidential -</p>	<p style="text-align: center;"><small>Schutzvermerk DIN ISO 16016 beachten! / Refer to protection notice DIN ISO 16016! Keine Änderung ohne Zustimmung der federführenden Konstruktion / Any alterations are subject to the approval of the design department</small></p> <p style="text-align: center;">Technical Component Requirement Specifications Tail lamp</p> <p style="text-align: center;">QEV 111 AJPNLG</p>	<p>Bearb./auth.: Hans Peter Schiffert</p> <p>Abt./dep.: RD/KEL</p> <p>Datum/date: 2022-07-25</p> <p>Requirement Specifications version: 001</p> <p>Seite/page: 12 of 220</p>
--	---	---

1 Introduction (STM-867451)

STM-867448
STLH-8H

These component requirement specifications (KLH) describe the requirements for the provision of services within the framework of the development or series production of component parts, modules, software, or components (hereinafter referred to as the "component" or the "scope of supply and services") by the vendor (hereinafter referred to as the "contractor") to Mercedes-Benz AG or the respective subsidiary or other affiliates of Mercedes-Benz AG to which the contractor has contractually agreed to deliver components or other content (hereinafter referred to as the "client").

1.1 Document Landscape (STM-867449)

STM-867450
STLH-1984F

Together with all other documents referenced here, these requirement specifications form the basis of the scope of supply to be provided by the contractor.

2831740

The German-language version of these requirement specifications shall be the sole binding version. Other language versions of the requirement specifications that are made available to suppliers shall not be binding.

STM-867452
STLH-5472C

References to other documents are shown in square brackets, e.g. [LHV 310 00x]. Documents referenced this way can be found in the chapter "Normative References" (see STLH-319). The download options using the DocMaster system are also described there.

1.1.1 Document Creation (STM-867456)

STM-867457
STLH-4649C

This document was generated from a database for requirements management. Maintenance and updating of this document is performed in this database.

STM-867454
STLH-4650D

In order to unambiguously identify document contents, the database assigns identifiers (IDs). The following forms of the identifier can appear in the document depending on the formatting used:

- ID on the left, text on the right (requirement)
- ID below the text (requirement)
- ID in brackets following a heading

1.1.2 Common Requirements (STM-867455)

STM-867458
STLH-4708B

The document entitled "Common Requirements Pertaining to the Component Requirement Specifications" [LHV 310 00x] contains requirements that are valid for all scopes of supply and services of the client.

STM-867462
STLH-4387C

In the case of deviations between the provisions of the requirement specifications and those in the Common Requirements [LHV 310 00x], the provisions described in the requirement specifications shall apply.

STM-867459
STLH-5456C

Chapters or requirements in [LHV 310 00x] are referenced not by chapter number but instead by the corresponding requirement ID, e.g. "Scheduling in the Project" CRQ-

Mercedes-Benz - Confidential -	<small>Schutzvermerk DIN ISO 16016 beachten! / Refer to protection notice DIN ISO 16016! Keine Aenderung ohne Zustimmung der federfuehrenden Konstruktion / Any alterations are subject to the approval of the design department</small>	Bearb./auth.: Hans Peter Schiffert
	Technical Component Requirement Specifications Tail lamp QEV 111 AJPNLG	Abt./dep.: RD/KEL Datum/date: 2022-07-25 Requirement Specifications 001 version: Seite/page: 13 of 220

162.

STM-867461
STLH-5540D

The Common Requirements are available in versions that contain differing details; for example, with and without electrical & electronic requirements. In this case, the document numbers differ in their end digits (wildcard character "x" in [\[LHV 310 00x\]](#)).

- LHV 310 001 = E/E + software + mechanics
- LHV 310 002 = Software scopes only
- LHV 310 003 = Mechanics scopes only
- LHV 310 004 = Assembly scopes
- LHV 310 005 = Software requirements (EvoBus)

These documents can be found in DocMaster under these document numbers.

STM-867460
STLH-5545

Section CRQ-3149 of the Common Requirements contains the most important changes made to the various versions of the standard template of the [component requirement specifications](#). This overview is for information only to facilitate orientation in the document. It does not release the contractor from the duty to undertake a detailed examination of the requirements with regard to any changes.

1.1.3 Logistics Component Requirement Specifications (STM-867465)

STM-867464
STLH-261D

With each sourcing scope, the contractor receives, via the "proSource" system, the logistics component requirement specifications (LOG-[KLH](#)) that also describe the logistics concept. The logistics concept will differ depending on the component part, the client plant, the form of delivery and the contractor's production and dispatch location. The contractor shall fulfill the requirements of the logistics component requirement specifications (LOG-[KLH](#)).

1.1.4 Excerpt from the Process Master Plan for Suppliers (STM-867463)

STM-867467
STLH-4641C

The document "Excerpt from the Process Master Plan for Suppliers" contains the most important skeleton schedule dates of the leading model series project for this scope of supply.

STM-867466
STLH-4642B

The contractor can obtain the "Excerpt from the Process Master Plan for Suppliers" via the "proSource" system.

1.1.5 Other Documents Pertaining to These Requirement Specifications (STM-867468)

STM-867469
STLH-9J

These requirement specifications and the other cited documents make reference to various types of documents, including:

- Implementation regulations ([AV](#))
- Function specifications ([FV](#))
- Drawings
- Standards or company standards ([MBN](#))
- Supply specifications ([DBL](#))
- Laws
- Additional component-specific specification documents.

These types of document are referred to below as "Normative References" ([MGUs](#)) pertaining to the requirement specifications and to the other cited documents.

Mercedes-Benz - Confidential -	Schutzvermerk DIN ISO 16016 beachten! / Refer to protection notice DIN ISO 16016! Keine Aenderung ohne Zustimmung der federfuehrenden Konstruktion / Any alterations are subject to the approval of the design department	Bearb./auth.: Hans Peter Schiffert Abt./dep.: RD/KEL Datum/date: 2022-07-25 Requirement Specifications 001 version: Seite/page: 14 of 220
	Technical Component Requirement Specifications Tail lamp QEV 111 AJPNLG	

STM-867471
STLH-4645C

The documents referenced in Chapter "Normative References" supplement the requirements described in the present document. The requirements set forth in these documents are hence likewise binding specifications for fulfilling the scope of supply and services.

STM-867470
STLH-4646B

If the present requirement specifications or the Common Requirements contain more stringent or less stringent specifications than are found in the Other Applicable Documents, the specifications contained in the requirement specifications and/or Common Requirements shall apply. No weakening of safety-relevant requirements or legal specifications is permitted.

STM-867472
STLH-6587A

If a company standard ([MBN](#) or [DBL](#)) is referenced in these requirement specifications or in the Common Requirements for Technical [KLH](#), the contractor shall check whether an approval of procurement source (BQF) for this company standard exists. The indication of an approval of procurement source is documented on the cover sheet of the company standard. It is possible to retrieve the approval of procurement source under document number "BQF ..." in DocMaster (example: [MBN](#) 12345 -> BQF 12345). The restrictions applied by the approval of procurement source shall be complied with in the context of the contract award.

STM-867474
STLH-6588

A BQF is needed whenever the company standard makes specific requirements that can or may only be provided by one or more particular suppliers, that need to be verified by means of special tests, or that can only be satisfied by particular products (quoting a trade or brand name and their manufacturers).

STM-880008
STLH-7007

Supplier drawings with the associated 2D/3D data records are the intellectual property of the supplier who created them. The disclosure of external supplier drawings by the contractor to competitors of the that supplier is only permitted with the written approval of the drawing owner (for example, in the context of supplier-bound parts).

STM-880010
STLH-7008

The procurement of directed parts is, as with a BQF, only permitted through the supplier documented on the supplier drawings; otherwise there is a risk of violating competition and intellectual property laws.

STM-880009
STLH-7009

In the case of drawings prepared by the client, there are no specifications governing the supplier for procurement.

1.2 General Specifications (STM-867476)

STM-867475
STLH-13A

The contractor shall treat all information and documents pertaining to development as confidential.

STM-867473
STLH-2666F

If the cited documents do not define requirements or define these differently, and these requirements are required for the flawless and unimpeded function and quality of the scope of supply, then the contractor shall reveal this to the client in writing.

STM-867477
STLH-10F

If in the course of performance the contractor wishes to deviate from the requirements described in the cited documents, the contractor shall require the written consent of the client.

STM-867479

If the contractor is familiar with quality or reliability-enhancing or cost-reducing

Mercedes-Benz - Confidential -	<small>Schutzvermerk DIN ISO 16016 beachten! /Refer to protection notice DIN ISO 16016! Keine Aenderung ohne Zustimmung der federfuehrenden Konstruktion / Any alterations are subject to the approval of the design department</small>	Bearb./auth.: Hans Peter Schiffert
	Technical Component Requirement Specifications Tail lamp QEV 111 AJPNLG	Abt./dep.: RD/KEL Datum/date: 2022-07-25 Requirement Specifications 001 version: Seite/page: 15 of 220

- STLH-2667G alternatives to the content of the cited documents, the contractor shall reveal these alternatives to the client in writing.
- STM-867478
STLH-2670A The contractor shall critically analyze the client's proposals and specifications and, if necessary, shall jointly develop improved solutions (shared responsibility).
- STM-867481
STLH-4653C The contractor shall ensure that the scope of supply meets all the requirements set forth in the requirement specifications. In particular, the contractor shall ensure that the planned tests and checks are suited to and sufficient for the development and delivery of a specification-compliant scope of supply, even in such cases where the type or number of tests and checks is proposed by the client. Should the contractor deem further tests and checks to be necessary, the contractor shall notify the client of this without delay and take appropriate action. Neither the performance of tests and checks by the contractor or client nor compliance with such tests and checks shall ever relieve the contractor of the obligation to fulfill the requirements of the requirement specifications. The contractor shall document fulfillment of the requirements in writing by means of test plans and reports.
- STM-867480
STLH-5510 The client is at all times authorized to demand changes and additions to the project description.
- STM-867482
STLH-5511 The contractor is obliged to propose to the client technical changes that the contractor deems necessary or practical. The contractor shall implement these changes after receiving the written approval of the client.
- STM-867485
STLH-5512 The contractor may reject changes or additions if these are deemed unreasonable and provided that notice of such rejection is immediately submitted to the client. The reasons for deeming them unreasonable shall be presented in writing.
- STM-867487
STLH-5513B To the extent that changes affect costs and/or deadlines, the contractor shall immediately upon receipt of the demand for changes or additions, or together with the contractor's proposal for changes, submit a cost estimate to the client with an itemized and justified listing of higher or lower costs as well as information on how deadlines may change. In such cases, the contractor shall not implement changes and additions until the parties to the contract have reached a written agreement. The written order to implement the changes may only be issued through the client's material supply process.
- STM-867484
STLH-2672B When designing the component, the contractor shall take all boundary conditions given by the overall vehicle into consideration. This refers in particular to space requirement investigations and associated tolerance considerations, assembly, feasibility of assembly, ease of servicing, visual matching with trim parts (inside and outside), environmental compatibility, country variants and the use of modular systems.
- STM-867483
STLH-2674B To meet the customer's demand for functionality and quality at the lowest possible cost, the contractor should submit its own proposals, stating the risks and potential benefits.
- STM-867486
STLH-12A The contractor shall select all component elements and suppliers in such a way that life cycle support is ensured for 15 years following the end of series production.
- STM-867488
STLH-2682C *The client reserves the right to use the scope of supply in other vehicle/engine model series as well.*

<p>Mercedes-Benz - Confidential -</p>	<p><small>Schutzvermerk DIN ISO 16016 beachten! / Refer to protection notice DIN ISO 16016! Keine Aenderung ohne Zustimmung der federfuehrenden Konstruktion / Any alterations are subject to the approval of the design department</small></p> <p>Technical Component Requirement Specifications Tail lamp QEV 111 AJPNLG</p>	<p>Bearb./auth.: Hans Peter Schiffert Abt./dep.: RD/KEL Datum/date: 2022-07-25 Requirement Specifications 001 version: Seite/page: 16 of 220</p>
---	---	--

STM-867492 STLH-2680C	The contractor shall not make changes to the scope of supply that limit the use of the scope of supply in the vehicle/engine model series.
STM-867490 STLH-5493A	Changes made by suppliers of parts to both the contractor and the client shall be agreed between the client and the general contractor. They will be prioritized by the client.
STM-867489 STLH-79A	The contractor shall coordinate the market-specific start-up curves with the market launch deadline in detail with the client.
STM-867491 STLH-2671A	Throughout the entire development period, the contractor shall analyze and reveal weight-reducing measures.
STM-867496 STLH-776F	Weight figures shall be broken down by the contractor on the basis of the parts list. They serve as the basis for future optimizations and the documentation thereof. Note that the components/item numbers at interfaces to adjacent modules are to be given full consideration.
STM-867494 STLH-1419G	In addition, the contractor shall offer at least one lightweight design variant of the subject component, this variant weighing less than the specified maximum weight. Consideration shall here be given to alternative materials, manufacturing processes and weight-optimized design.
STM-867495 STLH-4549B	The contractor shall reveal the weight reduction potential and any additional costs of the lightweight solution versus the conventional manufacturing process to the client.

Mercedes-Benz - Confidential -	Schutzvermerk DIN ISO 16016 beachten! /Refer to protection notice DIN ISO 16016! Keine Aenderung ohne Zustimmung der federfuehrenden Konstruktion / Any alterations are subject to the approval of the design department	Bearb./auth.: Hans Peter Schiffert Abt./dep.: RD/KEL Datum/date: 2022-07-25 Requirement Specifications 001 version: Seite/page: 17 of 220
	Technical Component Requirement Specifications Tail lamp QEV 111 AJPNLG	

2 Scope of Supply and Services (STM-867493)

2.1 Component-Specific Requirements (STM-867946)

2.1.1 Short Description and Development Scope (STM-867945)

STM-867949
STLH-2676

The component described in these requirement specifications is referred to as taillight combination.

STM-867947
STLH-2677A

TL has been defined as the mandatory abbreviation for the component.

2.1.2 Project Specifications (STM-867948)

2.1.2.1 Assignment of the Component to the Vehicle/Engine Model Series (STM-867952)

2.1.2.1.1 Assignment (STM-867950)

STM-867953
STLH-74C

The use of the component described in these requirement specifications is planned for use in »model series X244/248«.

2.1.2.1.2 Market Launch (STM-867951)

STM-867954
STLH-78C

For the described component, a distinction is made between the »BEV (X244) variant and the HEV (X248) variant on the continuous reflector strip of the rear-end door«. No distinction is made between the lamps on the left and the right sidewall. For the component described, no distinction is made between country variants.

2.1.2.2 Part ID Number (STM-867959)

STM-867955
STLH-394

The following part ID number is defined:

STM-867957
STLH-1619C

Mercedes-Benz part ID No.: A2449062901
Designation: TB ZB REAR LAMP COMBINATION

STM-867957
STLH-1619C

Mercedes-Benz part ID No.: A2449069600
Designation: ZB REAR LAMP COMBINATION RH LED SIDE WD

STM-867957
STLH-1619C

Mercedes-Benz part ID No.: A2449069500
Designation: ZB REAR LAMP COMBINATION LH LED SIDE WD

STM-867957
STLH-1619C

Mercedes-Benz part ID No.: A2449069700
Designation: ZB REAR LAMP COMBINATION M-PART

STM-867957

Mercedes-Benz part ID No.: A2489063500

Mercedes-Benz - Confidential -	<small>Schutzvermerk DIN ISO 16016 beachten! /Refer to protection notice DIN ISO 16016! Keine Aenderung ohne Zustimmung der federfuehrenden Konstruktion / Any alterations are subject to the approval of the design department</small>	Bearb./auth.: Hans Peter Schiffert
	Technical Component Requirement Specifications Tail lamp QEV 111 AJPNLG	Abt./dep.: RD/KEL Datum/date: 2022-07-25 Requirement Specifications 001 version: Seite/page: 18 of 220

2.1.2.3 Variants to Be Offered (STM-867956)

3214106 The variants to be offered can be found in the RFQ drawing, provided in the source package.

2.1.2.4 Installation Location in the Vehicle (STM-867958)

STM-867964
STLH-431 *The component is installed in the "rear end"*

2.1.2.5 Supplier development costs engineering (LEK-E) payment plan (STM-2912031)

STM-2912033 The development services described in these component requirement specifications at the contractor's premises (LEK-E – Supplier Development Costs Engineering) shall be remunerated by the client according to development progress. Invoicing or remuneration can only take place for development work already performed and accepted by the client and is defined by the following payment plan. The payment plan is based on the milestones from the excerpt from the Process Master Plan (PMP) for suppliers. If the client has accepted the milestones described below, the contractor can invoice the agreed-on content of the supplier development costs for engineering.

Milestone	Payment according to LEK-E percentage
DF ABEL	5%
VDMF	15%
"_" release	15%
ESWFT	25%
Yellow PPAR	30%
Green PPAR	10%

2.1.3 System Context (STM-867962)

2.1.4 Functions (STM-867960)

2.1.4.1 Basic Driving Functions (STM-868024)

STM-868026
STLH-6230B For function validation in the system group, the contractor shall provide the essential basic functions at the time of the first lab release. These include :

- Flashability in accordance with the definition in [Daimler Diagnostic Specifications] (see also CRQ-98) [\[LHV 310 00x\]](#)
- Full implementation of secure diagnosis incl. secure coding and CCCv2
- On-board electrical system functions (see STLH-873 et seq.)
- Basic driving functions for road approval

<p>Mercedes-Benz - Confidential -</p>	<p><small>Schutzvermerk DIN ISO 16016 beachten! /Refer to protection notice DIN ISO 16016! Keine Aenderung ohne Zustimmung der federfuehrenden Konstruktion / Any alterations are subject to the approval of the design department</small></p> <p>Technical Component Requirement Specifications Tail lamp</p> <p>QEV 111 AJPNLG</p>	<p>Bearb./auth.: Hans Peter Schiffert Abt./dep.: RD/KEL Datum/date: 2022-07-25 Requirement Specifications 001 version: Seite/page: 19 of 220</p>

STM-868027
STLH-6231

At the latest, the samples for the test vehicles in road operation (e.g. ATG-E/EF-Low) must comply with the EPDM quiescent current values:
- All components upstream of the on-board electrical system disconnect switch (currently EIS, KeylessGo and VTA) shall then comply with the respective maximum permitted quiescent current values as specified by EPDM.
- All components downstream of the on-board electrical system disconnect switch are safely deactivated if the vehicle's quiescent current is too high. For this reason, a quiescent current that is above specification may, in consultation with the client, be accepted for samples.

STM-868025
STLH-6232A

There are no specific basic driving functions for the component.

The basic driving functions relevant for the component are as follows:

2.1.5 Properties (STM-868051)

2.1.5.1 Target Weight Specification (STM-868050)

STM-868052
STLH-775

Maximum weight of » **ZB rear lamp combination X244/248** «: »4.8« kg

2.1.5.2 Corrosion Protection (STM-868056)

STM-868057
STLH-4723C

The contractor shall adhere to the standardized requirements in Chapter CRQ-2261 "Corrosion Protection" in the document [\[LHV 310 00x\]](#).

2.1.5.3 Material Selection/Material Specification (STM-868055)

STM-868059
STLH-4691C

During material selection, the contractor shall observe the document [\[LHV 310 00x\]](#), Chapter CRQ-606 "Substance Bans" and Chapter CRQ-2651 "Substance Requirements".

2.1.5.3.1 Alternative Materials (STM-868064)

STM-868066
STLH-6602B

The use of secondary material (metal/plastic recycled material) is vital. The use of renewable raw materials is expressly desired. For the criteria and requirements, the contractor shall observe requirement CRQ-3798 in the document [\[LHV 310 00x\]](#).

2.1.5.4 Tolerance Requirements (STM-868070)

2831400

The binding tolerances for the component parts described here can be found in the source package as normative references. The supplier shall comply with these tolerances.

STM-868072
STLH-4724E

With regard to tolerances, the contractor shall comply with Chapter CRQ-2306 "Tolerances" in the document [\[LHV 310 00x\]](#).

<p>Mercedes-Benz - Confidential -</p>	<p style="font-size: small;">Schutzvermerk DIN ISO 16016 beachten! /Refer to protection notice DIN ISO 16016! Keine Aenderung ohne Zustimmung der federfuehrenden Konstruktion / Any alterations are subject to the approval of the design department</p> <p style="text-align: center;">Technical Component Requirement Specifications Tail lamp QEV 111 AJPNLG</p>	<p>Bearb./auth.: Hans Peter Schiffert Abt./dep.: RD/KEL Datum/date: 2022-07-25 Requirement Specifications 001 version: Seite/page: 20 of 220</p>
---	---	--

2.1.5.5

Component Identification (STM-868074)

STM-868076
STLH-2024I

The identification of components is described for production parts in the logistics component requirement specifications and for test parts in the document [\[LHV 310 00x\]](#) in the Chapter "Designation of Parts" under Requirement ID CRQ-216.

2.1.6

Interfaces (STM-868075)

2.1.6.1

Mechanical Interfaces (Fixation Concept) (STM-868082)

STM-868089
STLH-4721C

General requirements pertaining to mechanical interfaces can be found in the document [\[LHV 310 00x\]](#) in Chapter CRQ-2334 "Mechanical System Assembly Requirements".

2.1.7

Mechanical Requirements for the Light (2123046)

2.1.7.1

General (2123050)

2123045
FI MH-10

Requirements and objectives for the components are described in detail in the following chapter. The components shall be designed by the contractor in consideration of all boundary conditions given by the overall vehicle. This refers in particular to installation studies and associated tolerance considerations, assembly, feasibility of assembly, ease of servicing, visual matching with paneling (inside and outside), environmental compatibility, country variants and the use of modular systems.

2123047
FI MH-1881

The development services consist of the re-design and its revision, creating drawings, PT tool design and the necessary supervision costs, development project management, etc. for the project.

2123054
FI MH-1844

The contractor shall reveal measures for the reduction of parts, costs and weight to the contact of the client's development department.

2123056
FI MH-3519

In the case of contradictory requirements between the component requirement specifications and the RFQ drawing, the requirement on the RFQ drawing has priority and shall be fulfilled.

2123052
FI MH-3523

During the course of the contract award process, changes to these requirement specifications are provided in the source package by "Supplementary component requirement specifications requirements." The most recent version of these requirements at the time of the contract award is binding and shall be fulfilled.

2123055
FI MH-3553

If the contractor makes changes to the technical description during the offer period, these shall be explicitly mentioned. An overview slide with change history shall be created. The template from the source package shall be used.

2123058
FI MH-3554

If objections to requirements are made, these shall be listed in a separate objection list. Documentation of the objections in another location is not permissible.

<p>Mercedes-Benz - Confidential -</p>	<p><small>Schutzvermerk DIN ISO 16016 beachten! /Refer to protection notice DIN ISO 16016! Keine Aenderung ohne Zustimmung der federfuehrenden Konstruktion / Any alterations are subject to the approval of the design department</small></p> <p>Technical Component Requirement Specifications Tail lamp QEV 111 AJPNLG</p>	<p>Bearb./auth.: Hans Peter Schiffert Abt./dep.: RD/KEL Datum/date: 2022-07-25 Requirement Specifications 001 version: Seite/page: 21 of 220</p>
---	--	--

2.1.7.2 Overview of Variants (2123059)

- 2123062
FI MH-1880 The contractor shall not create any further country-specific variants in addition to those variants defined in the drawing.
- 2123061
FI MH-2185 If there are different lamps for ECE and SAE, openings for LEDs and attachment openings need to be covered, for example.
- 2123065
FI MH-2855 If there are different lamps for ECE and SAE, all the country-specific characteristics may only exist in the affected country variants. This means that side reflectors, side marker lamps, illuminant openings (e.g. for USA side marker lamp), openings for LEDs, attachment openings, markings for interchangeable inserts/slides, etc. shall not be present and/or visible in the non-affected country variant.
- 2123347
FI MH-3400 If there are different lamps for ECE and SAE, the rear fog lamp function shall be implemented on one side, in line with the country variant.
- 2752448 If a global lamp is required, this means that the lamp shall be homologation-capable worldwide. In this variant, the rear fog light shall be installed on both sides.
- 2123202
FI MH-2715 If a distinction is made between a basic type lamp and an SA lamp, what is referred to as a "functional brake light in LED design" is used for the basic type variant(s).
The term "functional brake light" means:
Cost-effective design of the light function taking all technical and legal requirements of the requirement specifications into account, however without additional design elements such as additional optical lenses or chrome applications.

2.1.8 Mechanical System Functions (2123113)

2.1.8.1 Day Design (2123114)

- 2123123
FI MH-3489 The contractor shall design the lamp so that no technology is visible in the lamp in the normal view of the lamp (0 degrees) up to 90 degrees from above. This includes, for example, the engagements, cables, connectors, connecting points, and threaded fasteners. The visibility of the light sources and PCBs shall be presented in concept review 1. Design measures for reducing the visibility of the PCBs and light sources shall be disclosed before concept review 1.
- 2123125
FI MH-121 The contractor shall design the lamp housing so that the visibility of the joint is concealed.
- 2123126
FI MH-122 The contractor shall design the lamp so that a uniform appearance of the joints to adjacent component parts is ensured.
- 2123129
FI MH-3548 The contractor shall design the lamp so that reflections of the technology in visible areas are avoided. Design measures such as structured surfaces and laminations shall be provided. These shall be disclosed for concept review 1 and have been implemented and confirmed for concept review 2.

Mercedes-Benz - Confidential -	<small>Schutzvermerk DIN ISO 16016 beachten! /Refer to protection notice DIN ISO 16016! Keine Aenderung ohne Zustimmung der federfuehrenden Konstruktion / Any alterations are subject to the approval of the design department</small>	Bearb./auth.: Hans Peter Schiffert Abt./dep.: RD/KEL Datum/date: 2022-07-25 Requirement Specifications 001 version: Seite/page: 22 of 220
	Technical Component Requirement Specifications Tail lamp QEV 111 AJPNLG	

2123133
FI MH-3537

The contractor shall design the lamp so that reflections of red areas of the lens in transparent/gray areas are not possible. Design measures shall be disclosed for concept review 1 and have been implemented and confirmed for concept review 2.

2123132
FI MH-2539

In the visible area (this also applies if the trunk lid or rear-end door is open), no manufacturer logo of the contractor is permitted.
Exceptions are legally required identifications that must be applied in the visible area. Positioning in coordination with the client (at the latest at concept review 2).

2123135
FI MH-231

The contractor shall design all lamp openings so that no "shadows" occur in the illuminated area.

2123140
FI MH-424

A consistent appearance of left TL and right TL shall be ensured.

2.1.8.2 Night Design (2123141)

2123139
FI MH-3357

The contractor shall design the lamp so that the interruption of the illuminating surfaces in the transition between the sidewall lamp and trunk lid lamp is max. 14 mm wide. This dimension does not apply if the lamp diagram (client's design data) or the RFQ drawing specifies a different dimension.
Maximum refers to the expansion of the lamp compartments.

2123142
FI MH-138

The contractor shall design the lamp so that max. and homogeneous illumination is achieved in the lamp flank for every lamp function.
Maximum refers to the contour of the lamp and the expansion of the lamp compartments specified by the development/design departments.

2123144
FI MH-2995

The contractor shall design the lamp so that no diffused light is visible through the joints/gaps to the body or adjacent component parts.

2.1.9 Mechanical System Properties (2123152)

2.1.9.1 Illuminants Used (General) (2123185)

2864715

The LED information included in the parts list of the RFQ drawing represents the minimum requirement and serves the comparability of the offers. The potential contractor is required to assess this information with regard to its technical intended use, taking into account the requirements described in these component requirement specifications. If the preparation of the offer shows that LEDs with greater or lesser luminous intensity are required, these shall be offered separately in the offer and in the price breakdown.

2123184
FI MH-3103

The contractor shall take into account in the offer all information on the LEDs, e.g. number and power class. The feedback shall be realized in the following form with the submission of tender.

2123190
FI MH-3539

Example:

Mercedes-Benz - Confidential -	<small>Schutzvermerk DIN ISO 16016 beachten! / Refer to protection notice DIN ISO 16016! Keine Aenderung ohne Zustimmung der federfuehrenden Konstruktion / Any alterations are subject to the approval of the design department</small>	Bearb./auth.: Hans Peter Schiffert Abt./dep.: RD/KEL Datum/date: 2022-07-25 Requirement Specifications version: 001 Seite/page: 23 of 220
	Technical Component Requirement Specifications Tail lamp QEV 111 AJPNLG	

Baureihe:			Datum:			Bearbeiter Lichttechnik						
Lieferant:			Version:			Bearbeiter Elektronik:						
Leuchte	Platine	Funktion	Anzahl LED's	Strom [mA] / LED	Anzahl Stränge	Lichtstrom [lm] / LED kalt	Lichtstrom [lm] / LED warm	elektr. Leistung [W] / Fkt. auf	Platinenfläche Netto [cm²]	Zulassungsforn	Dominante Wellenlänge (inkl.)	Bemerkung
SWL												
SL Animation												
SWL	PCB1	SL	42	20	21	2	1,8	2,73		1-Kammer	633	
SWL	PCB1	Animation	12	20	6	2	1,8	0,78			633	
SWL	PCB1							0				
FRA RFS												
SWL	PCB2	FRA	12	140	6	24	14,4	5,46			589	
SWL	PCB2	RFS	4	350	2	134	120	8,96				
SWL	PCB2							0				
BL												
SWL	PCB3	BL	10	40	5	6,08	5	1,3			625	
SWL	PCB3							0				
SWL	PCB3							0				
BL												
SWL	PCB4	BL	10	40	5	6,08	5	1,3			625	
SWL	PCB4							0				
SWL	PCB4							0				
SL												
HDL	PCB5	SL	6	50	3	6	4,8	0,975				
HDL	PCB5							0				
HDL	PCB5							0				
SL												
HDL	PCB6	SL	4	50	2	6	4,8	0,65			633	
HDL	PCB6							0				
HDL	PCB6							0				
Animation												
HDL	PCB7	Animation	10	20	5	2	1,8	0,65			633	
HDL	PCB7							0				
HDL	PCB7							0				
NSL												
HDL	PCB8	NSL	2	300	1	53	42,5	1,95			624	
HDL	PCB8							0				
HDL	PCB8							0				

2123188
FI MH-3546

The feedback shall additionally be provided in the form of a standardized Excel file. The illuminant table is provided in the source package.

2123192
FI MH-3104

The contractor shall disclose possible cost-saving potential with regard to the number of LEDs and LEDs used and report this as an optional integral part in the offer.

2123196
FI MH-1998

If light sources are **not** relevant from a technical light viewpoint, they shall be noted/listed separately in the tender.

2123199
FI MH-14

The contractor shall define all lamp functions precisely and explicitly and disclose the approval requirements.

2.1.9.2

Component-Specific Tolerance Data (2123207)

2123208
FI MH-3011

The binding tolerance specifications for the component parts described here can be found in the source package as normative references.

2123214
FI MH-3287

In accordance with [\[MBN 11012-30\]](#), the following applies:
General surfaces: Tolerance class 1-m
Position of tool-related holes: Tolerance class 1-m
Tool-related material thickness: 1-f

Mercedes-Benz - Confidential -	Schutzvermerk DIN ISO 16016 beachten! / Refer to protection notice DIN ISO 16016! Keine Aenderung ohne Zustimmung der federfuehrenden Konstruktion / Any alterations are subject to the approval of the design department	Bearb./auth.: Hans Peter Schiffert Abt./dep.: RD/KEL Datum/date: 2022-07-25 Requirement Specifications version: 001 Seite/page: 24 of 220
	Technical Component Requirement Specifications Tail lamp QEV 111 AJPNLG	

Tool-related edges: 1-m

2123215
FI MH-3288

The contractor shall fully confirm all tolerance requirements indicated in the RFQ documents; this is a mandatory requirement for contract award by the client. This confirmation shall be made in the technical description. If explicit reference to the tolerance requirements is not made in the offer, the tolerance requirements are considered as confirmed by the contractor.

2123216
FI MH-1656

The contractor shall create a tolerance study for the entire lamp. This will be discussed with the client at the milestones concept review 1 and concept review 2. The tolerance study is a component of the release drawing.

2.1.9.3

Material Selection/Material Specification (2123220)

2123223
FI MH-3407

The contractor shall take into account the Common Requirements [\[LHV 310 001\]](#) in the Chapter "Environmental Compatibility and Material Bans/Requirements" CRQ-410 during material selection.

2123224
FI MH-1558

If the contractor uses auxiliary materials (lubricants, etc.) during production, the auxiliary materials shall not impair the lamp function.

2123226
FI MH-3487

The use of Mg, corrosion-resistant CrNi steels, and CFRP is permitted after consultation with the Corrosion Protection Development department.

2654493

The material data included in the parts list of the RFQ drawing helps to provide comparability of the offers. The potential contractor is required to assess this information with regard to its technical intended use, taking into account the requirements described in these component requirement specifications. If it is aware of quality-increasing and/or cost-reducing materials, these shall be indicated separately in the offer.

2.1.9.4

Thermal Management (2123244)

2123245
FI MH-3396

The contractor shall perform temperature simulations on the overall system of the component part based on the requirements in Chapter 1.10 "Testing of the Rear". These shall be agreed on with the client at the latest by concept review 1.

2123243
FI MH-3397

The contractor shall determine the critical situations of the component part and implement corresponding design measures. These shall be agreed on with the client at the latest by concept review 2.

2123246
FI MH-3398

The contractor shall, if required, provide testworthy samples for temperature measuring drives and compare the results of the measuring drive with the simulation (test review 1).

Mercedes-Benz - Confidential -	<small>Schutzvermerk DIN ISO 16016 beachten! /Refer to protection notice DIN ISO 16016! Keine Aenderung ohne Zustimmung der federfuehrenden Konstruktion / Any alterations are subject to the approval of the design department</small>	Bearb./auth.: Hans Peter Schiffert
	Technical Component Requirement Specifications Tail lamp QEV 111 AJPNLG	Abt./dep.: RD/KEL Datum/date: 2022-07-25 Requirement Specifications version: 001 Seite/page: 25 of 220

2.1.10 Mechanical System Interfaces (2123297)

2.1.10.1 Overview of Mechanical System Interfaces (2123294)

2123295 FI MH-634 The lamp interfaces shall be agreed on with the Overall Vehicle area:

- 2123298 FI MH-635 . *Bodyshell*
- 2123296 FI MH-2867 . *Corrosion protection (body seam sealing)*
- 2123303 FI MH-636 . *Interior trim*
- 2123302 FI MH-2540 . *Rear-end door/trunk lid*
- 2123304 FI MH-2541 . *Handle strip*
- 2123308 FI MH-2865 . *Inner fender skirts (trunk)*
- 2123307 FI MH-637 . *Rear bumper*
- 2123310 FI MH-2852 . *Bumper bracket to lamp*
- 2123309 FI MH-639 . *Wiring harness electrical components including connectors and fasteners*
- 2123314 FI MH-642 . *Weld cover*

2.1.10.2 Mechanical Loads (2123322)

2123321 FI MH-650 For the tool release, the contractor shall confirm the strength of the attachment points to the vehicle via an FEM analysis. This shall be submitted to the client for the milestone concept review 2.

2123320 FI MH-651 *The boundary conditions for the FEM analyses are defined in the Chapter "Test Specifications for all Parts of the Sourcing Scope".*

2123323 FI MH-652 The contractor shall provide the simulation results to the client's Development contact in an agreed-upon interchange format.

2.1.10.3 Lamp Ventilation (2123334)

2123335 FI MH-3404 *The lamp ventilation serves for pressure compensation between atmospheric pressure and the pressure in the lamp.*

<p>Mercedes-Benz - Confidential -</p>	<p style="font-size: small;">Schutzvermerk DIN ISO 16016 beachten! /Refer to protection notice DIN ISO 16016! Keine Aenderung ohne Zustimmung der federfuehrenden Konstruktion / Any alterations are subject to the approval of the design department</p> <p style="text-align: center;">Technical Component Requirement Specifications Tail lamp QEV 111 AJPNLG</p>	<p>Bearb./auth.: Hans Peter Schiffert Abt./dep.: RD/KEL Datum/date: 2022-07-25 Requirement Specifications 001 version: Seite/page: 26 of 220</p>
---	---	--

2123336
FI MH-2507

The contractor shall design the lamp so that an ingress of environmental influences (e.g. dust and dirt particles or insects) is effectively prevented.

2123338
FI MH-2701

The contractor shall design the lamp so that no moisture (water, operating fluids, etc.) can accumulate.

2123337
FI MH-748

The openings shall be designed for standard profiles and/or for the requirements and attachment of pressure compensation elements.

2.1.11 Component Design (2123340)

2123342
FI MH-3505

The contractor shall take the geometric specifications from the RFQ drawing. The concept cross sections are used to present the structure of the lamp.

2.1.11.1 General Design Guidelines (2123348)

2123345
FI MH-3291

Supplementary requirements and information on the RFQ drawing can be found in this chapter.

2123349
FI MH-3486

The parts list of the RFQ drawing only includes the main components. Potentially necessary additional parts required for technical realization and implementation of the design shall be listed in the tender and in the price breakdown.

2123352
FI MH-2479

The contractor shall design the lamp so that the minimum distance to all adjacent component parts (bodyshell/seam sealing/etc.) is 3 mm. An exception to this rule are fastening and reference points as well as seals and edge strips.

2123354
FI MH-3064

If the distance is less than 3 mm, the constriction shall be documented by means of a measuring point in the measuring plan and subjected to a tolerance check. The measuring point shall be included in the release drawing.

2123356
FI MH-2408

The contractor shall design the lamp so that no crazing points arise in the case of engagements/engaging lugs.

2123358
FI MH-3485

For lamps in the trunk lid/rear-end door, the contractor shall provide water-guiding elements to prevent water from entering the trunk when opening the trunk lid/rear-end door.

2.1.11.2 Alignment and Attachment (2123360)

2.1.11.2.1 General (2123359)

2123363
FI MH-2649

During the assembly process (joining of lamps in body), it shall be possible to precisely position the lamp without any intervention by the worker. The contractor shall have available/develop a corresponding assembly concept.

2123367
FI MH-3353

All fasteners for lamp assembly on the body shall have the same thread size.

<p>Mercedes-Benz - Confidential -</p>	<p><small>Schutzvermerk DIN ISO 16016 beachten! /Refer to protection notice DIN ISO 16016! Keine Aenderung ohne Zustimmung der federfuehrenden Konstruktion / Any alterations are subject to the approval of the design department</small></p> <p>Technical Component Requirement Specifications Tail lamp QEV 111 AJPNLG</p>	<p>Bearb./auth.: Hans Peter Schiffert Abt./dep.: RD/KEL Datum/date: 2022-07-25 Requirement Specifications 001 version: Seite/page: 27 of 220</p>
---	--	--

2123364
FI MH-2606

The contractor shall design the lamp so that the lamp fasteners do not exert excess pressure on the seal.

2123366
FI MH-2705

The connection to the body shall be coordinated with the client's Overall Vehicle Corrosion Protection department according to the material used on the body.

2123365
FI MH-2707

All single part coatings of the components shall be included in the drawing in a table. The entry on the drawing for the assembly component test is to be agreed with the client's department Corrosion Protection, Overall Vehicle.

3097249

The binding definition of the alignment plan for the component parts described here can be found as another applicable document (tolerance sheet) in the source package.

2.1.11.2.2

Cross Pin (2123368)

3097251

If the tolerance sheet requires an alignment of the lamps using a cross pin, the following requirements shall be complied with.

2123372
FI MH-3295

The body opening in which the cross pin engages shall be sealed by a seal. The seal is an integral part of the ZB tail lamp.

2.1.11.2.3

Spacers / Min. Gap Limiters (2123370)

3097255

If the tolerance sheet requires an alignment of the lamps using a spacers/min. gap limiters, the following requirements shall be complied with.

Mercedes-Benz - Confidential -	<small>Schutzvermerk DIN ISO 16016 beachten! /Refer to protection notice DIN ISO 16016! Keine Aenderung ohne Zustimmung der federfuehrenden Konstruktion / Any alterations are subject to the approval of the design department</small>	Bearb./auth.: Hans Peter Schiffert
	Technical Component Requirement Specifications Tail lamp QEV 111 AJPNLG	Abt./dep.: RD/KEL Datum/date: 2022-07-25 Requirement Specifications 001 version: Seite/page: 28 of 220

2123375
FI MH-2642

Spacer means that the specified gap dimension is created by fitting a spacer on the body.

2123376
FI MH-3385

Spacer Prinzipschnitt Ausschnitt (M5:1)

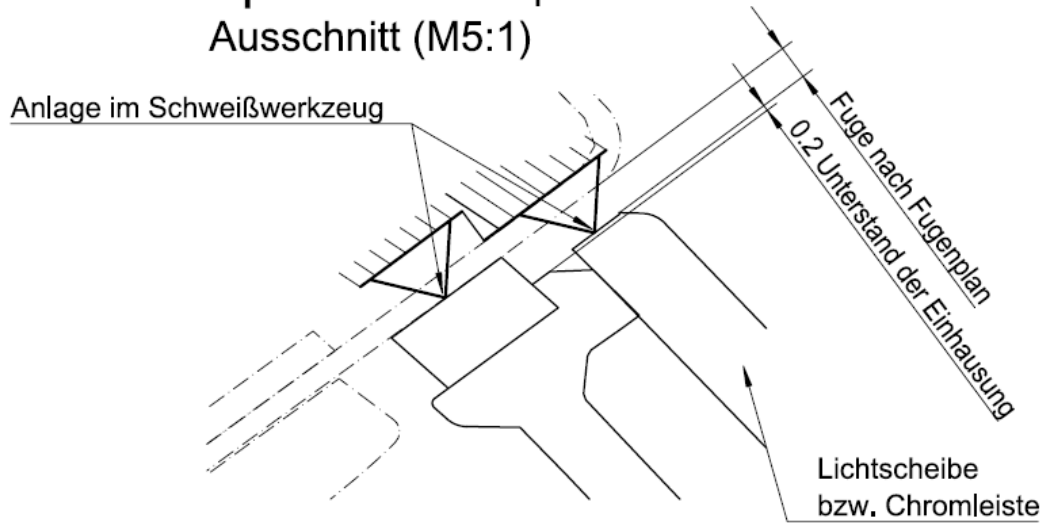

Bsp. für Anschlag abgewand der Lichtscheibe M 2:1

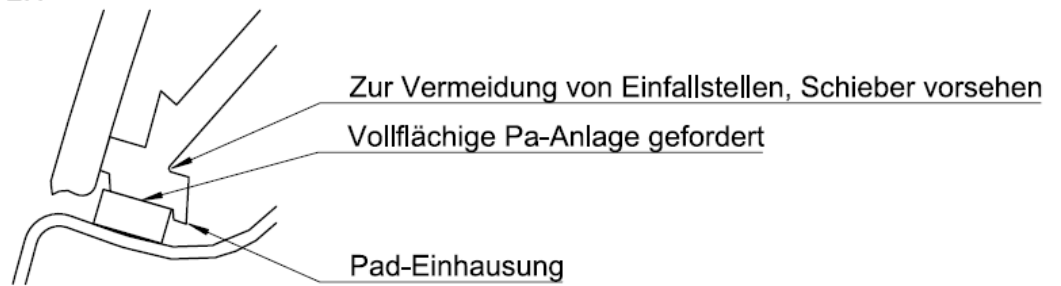

2123374
FI MH-3538

If spacer pads are envisaged for the positioning, additional surfaces with parallel alignment within the reference grid in accordance with the lower drawing shall be provided.

<p>Mercedes-Benz - Confidential -</p>	<p><small>Schutzvermerk DIN ISO 16016 beachten! /Refer to protection notice DIN ISO 16016! Keine Aenderung ohne Zustimmung der federfuehrenden Konstruktion / Any alterations are subject to the approval of the design department</small></p> <p>Technical Component Requirement Specifications Tail lamp QEV 111 AJPNLG</p>	<p>Bearb./auth.: Hans Peter Schiffert Abt./dep.: RD/KEL Datum/date: 2022-07-25 Requirement Specifications version: 001 Seite/page: 29 of 220</p>
---	--	---

Ansicht Z

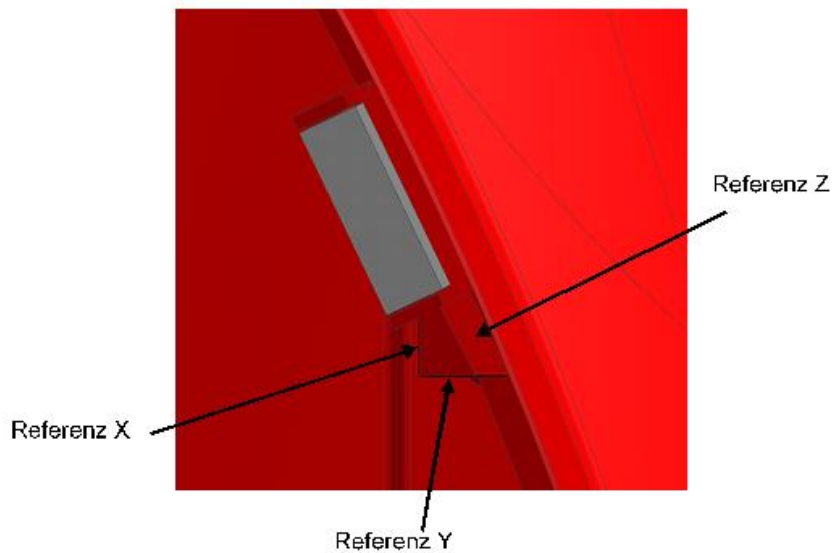
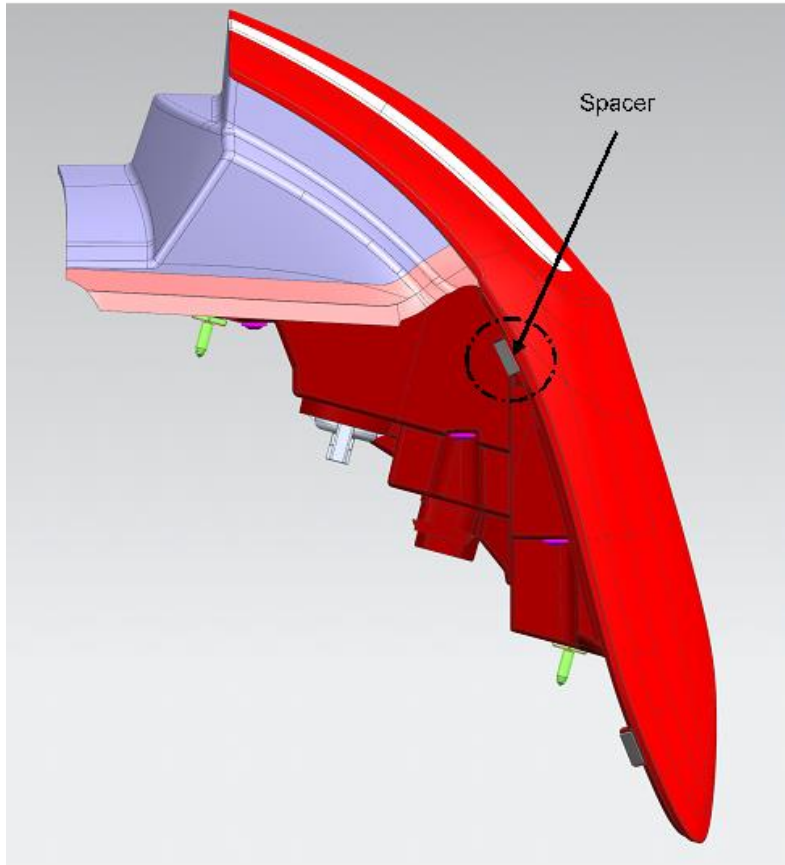

2123377
FI MH-3503

The housings for min. gap limiters and spacers that are aligned with the bodyshell shall not have a sharp-edged design

2123378

Min. gap limit means that contact with the lens is prevented during the installation of

<p>Mercedes-Benz - Confidential -</p>	<p><small>Schutzvermerk DIN ISO 16016 beachten! /Refer to protection notice DIN ISO 16016! Keine Aenderung ohne Zustimmung der federfuehrenden Konstruktion / Any alterations are subject to the approval of the design department</small></p> <p>Technical Component Requirement Specifications Tail lamp QEV 111 AJPNLG</p>	<p>Bearb./auth.: Hans Peter Schiffert Abt./dep.: RD/KEL Datum/date: 2022-07-25 Requirement Specifications version: 001 Seite/page: 30 of 220</p>
---	--	---

FI MH-3076

the rear lamp. In the nominal installation, the min. gap limiters are not in contact with the bodyshell.

2123381
FI MH-3552

Mindestspaltbegrenzer Prinzipschnitt Ausschnitt (M5:1)

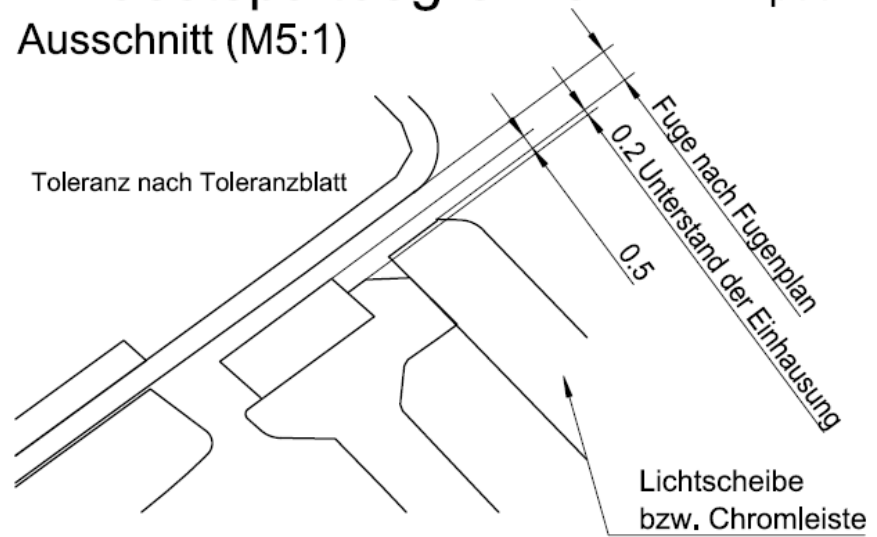

Bsp. für Anschlag abgewand der Lichtscheibe

M 2:1

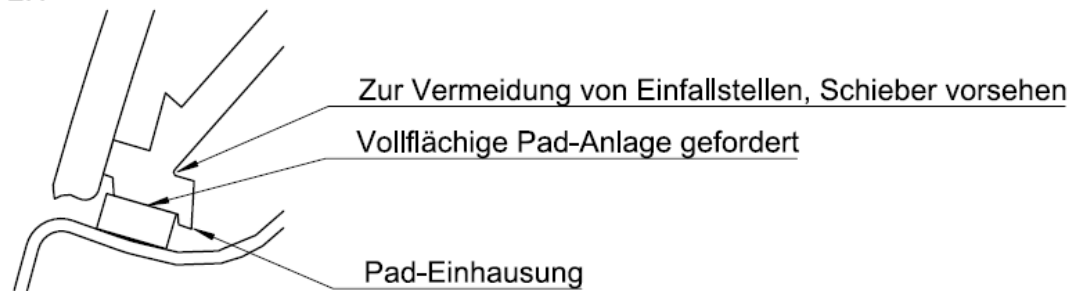

The min. gap of 0.5 mm shall be ensured by a min. gap limiter.

2123383
FI MH-3384

The contractor shall also take the spacers into account in the tolerance evaluation.

2123387
FI MH-2871

The contractor shall design the lamp so that the min. gap limiters/spacers are positioned on the lamp housing.

2123384
FI MH-3402

Where chrome trims are used, it shall be checked whether the min. gap limiter/spacer can be attached to the lens (behind the chrome trim).

2123386
FI MH-3549

The contractor shall design the lamp so that the min. gap limiter / spacer is fastened to the lamp across its entire surface area and secured against falling off.

2123388
FI MH-2509

The contractor shall design the lamp so that the min. gap limiters/spacers do not detach during transport (e.g. in the load containers) to the installation location.

2123392
FI MH-2510

The contractor shall design the lamp so that the min. gap limiters/spacers do not detach during assembly in the body.

Mercedes-Benz - Confidential -	<small>Schutzvermerk DIN ISO 16016 beachten! / Refer to protection notice DIN ISO 16016! Keine Aenderung ohne Zustimmung der federfuehrenden Konstruktion / Any alterations are subject to the approval of the design department</small>	Bearb./auth.: Hans Peter Schiffert Abt./dep.: RD/KEL Datum/date: 2022-07-25
	Technical Component Requirement Specifications Tail lamp QEV 111 AJPNLG	Requirement Specifications 001 version: Seite/page: 31 of 220

2123389
FI MH-3212

Tolerance adjustment, e.g. at the attachment surfaces for min. gap limiters/spacers, (including multiple adjustments) is an integral part of the basic offer.

2.1.11.2.4 Preattachment of Lamp (2123390)

2123391
FI MH-2992

The lamp shall maintain its position on its own after insertion into the body (the lamp shall be secured against falling down prior to bolting).

2123393
FI MH-3387

Background: The worker shall equip the tool with the fastener.

2.1.11.2.5 Fasteners (2123394)

2.1.11.2.5.1 General (2123397)

2123398
FI MH-2622

The contractor shall design the lamp so that the fasteners do not detach from the lamp housing during lamp disassembly.

2123395
FI MH-2619

The contractor shall design the lamp so that the openings in the bodyshell for the fasteners are closed with seals.

2123402
FI MH-3118

The seal of the fastener shall lose max. 5% of its thickness when the threaded connection is tightened with the rated torque.

2123399
FI MH-2514

The fasteners for the assembly of the lamp on the body shall be designed so that they have a collar that rests on the body panel (lamp mount in the bodyshell). The collar diameter shall be dimensioned so that the collar is in all-round contact with the panel in all tolerance and assembly positions.

2123401
FI MH-3518

The contact surface of the fastener shall be produced for the nominal dimension (see RPS system) via the bolt or a plastic collar.

2123403
FI MH-3389

The diameter of the fasteners is specified as $d = M5$.

2123404
FI MH-2624

To minimize the installation time, threaded bolts shall be designed to be as short as possible. The stud length shall be specified in coordination with the client's Development department (by concept review 2 at the latest)

2.1.11.2.5.2 Adjustment Controls (2123405)

2753562

If the RFQ drawing calls for adjustability of the lamps, the following requirements shall be complied with.

2123407
FI MH-2545

The adjusting mechanism of the lamp shall be designed so that the fasteners do not need to be fully disassembled for the adjustment process.

2123410
FI MH-2546

If an inline measuring system is planned, the adjusting element shall be set in the inline measuring system.

2123411

After adjustment at the contractor's plant, the adjusting element shall be protected

Mercedes-Benz - Confidential -	<small>Schutzvermerk DIN ISO 16016 beachten! / Refer to protection notice DIN ISO 16016! Keine Aenderung ohne Zustimmung der federfuehrenden Konstruktion / Any alterations are subject to the approval of the design department</small>	Bearb./auth.: Hans Peter Schiffert Abt./dep.: RD/KEL Datum/date: 2022-07-25 Requirement Specifications 001 version: Seite/page: 32 of 220
	Technical Component Requirement Specifications Tail lamp QEV 111 AJPNLG	

FI MH-2183

against twisting (e.g. mask).

2123409
FI MH-3429

The contractor shall design the component in such a way that a minimum adjustment range of ±1 mm is ensured in the MB AG plant.

2123412
FI MH-2484

The contractor shall design the component so that it does not need to be adjusted at the client's plant. If the requirements necessitate an adjustment option in the opinion of the contractor, the option shall be provided.

2.1.11.2.5.3 Double-Threaded Pin (2123413)

2753576

If the RFQ drawing calls for fastening of the lamps with double-threaded pins, the following requirements shall be complied with.

2123415
FI MH-3543

The double-threaded pin shall be sealed off from the bodyshell with a sealing washer.

2123414
FI MH-3544

The diameter of the sealing washer and the retainer or the width across flats of the hexagon of the threaded pin shall be dimensioned so that the sealing function is maintained in the event of the maximum eccentric position of the threaded pin in the fastening hole.

3333715

The stud is made from steel with at least property class 8.8

2.1.11.2.5.4 Threaded Pin with Flat Guide (Slide-In Stud) (2123416)

2123419
FI MH-3390

If the RFQ drawing calls for a fastening of the lamps with threaded pins with flat guide (slide-in stud), the following requirements shall be complied with.

2123420
FI MH-3427

In combination with the housing, the threaded stud with flat guide shall ensure a tolerance compensation in a spatial direction (e.g. Y-direction).

2123422
FI MH-3428

Tolerance adjustment, e.g. at the attachment surfaces for threaded studs with flat guide (including multiple adjustments), is an integral part of the basic offer.

2123423
FI MH-3235

The stud is made from steel with at least property class 8.8

2.1.11.2.5.5 Clamping Claw (2123435)

2753579

If the RFQ drawing calls for fastening of the lamps with a clamping claw, the following requirements shall be complied with.

2123437
FI MH-3555

The contractor shall design the clamping claw so that a homogeneous force distribution to the seal is ensured.

2123436
FI MH-3297

The lamp assigned to the trunk lid is secured to the body with a clamp.

2123438
FI MH-3321

If the clamping claw is used in combination with spacers and/or min. gap limiters, the clamping claw shall be designed so that the spacers and/or min. gap limiters independently come into contact with the body during lamp assembly.

2753583

Independently come into contact with the body means that, for instance, the worker

<p>Mercedes-Benz - Confidential -</p>	<p><small>Schutzvermerk DIN ISO 16016 beachten! / Refer to protection notice DIN ISO 16016! Keine Aenderung ohne Zustimmung der federfuehrenden Konstruktion / Any alterations are subject to the approval of the design department</small></p> <p>Technical Component Requirement Specifications Tail lamp QEV 111 AJPNLG</p>	<p>Bearb./auth.: Hans Peter Schiffert Abt./dep.: RD/KEL Datum/date: 2022-07-25 Requirement Specifications 001 version: Seite/page: 33 of 220</p>
---	---	--

does not need to slide or push the lamp in a given direction.

2123439
FI MH-3312

The clamping claw shall be designed so that all clamping claw arms engage audibly when inserting the lamp into the body.

2123441
FI MH-3313

The clamping claw shall be designed (geometry and material) so that all occurring forces (e.g. the sealing force) can be absorbed without impairing the function.

2123442
FI MH-3314

The mounting nut(s) shall not come loose from the clamping claw during installation of the lamps.

2123440
FI MH-3315

The clamping claw is preset to a specified dimension in the as-delivered condition.

2123443
FI MH-3322

This preset dimension shall not be adjusted in transit.

2123446
FI MH-3316

Determination of the preset dimension takes place based on the buildability validation in the confirmation vehicle phase.

2123445
FI MH-3317

The contractor shall determine the dimensioning of the clamping claw using the FE method.

2123448
FI MH-3318

The result of the FE analysis shall be presented to the client during concept review 2.

2123444
FI MH-3319

The elastic deformation in the body/clamping claw/lamp system shall be taken into account when designing the clamping claw.

2123447
FI MH-3320

As a result of the interplay of tolerance effect, intervention by the worker, and elastic deformation, the final geometry of the clamping claw cannot be specified at the start of tool production.

The tool shall therefore be designed so that the function dimensions of the claw can be coordinated after off-tool parts.

The modification effort for this (at least 3 iterations) is an integral part of the basic tender.

2123451
FI MH-2621

The seals of the fasteners shall meet the requirements of the tolerance concept (dimensional reference system).

2123453
FI MH-2637

The clamping claw(s) is (are) arranged at the bottom edge of the housing so that when the lamp is fitted into the body the lamp will be automatically pressed upward (vehicle Z coordinate) without action by the mechanic and the spacers will come to rest at the lamp aperture (body).

2.1.11.3

Design Name Panel (2123452)

2123457
FI MH-2869

For general information about labeling (manufacturer's logo, etc.), see the Chapter "After-Sales Requirements".

2.1.11.4

Off-Tool Design Name Panel (2753587)

2753594

If the RFQ drawing calls for off-tool design lettering, the following requirements shall be complied with.

Mercedes-Benz - Confidential -	<small>Schutzvermerk DIN ISO 16016 beachten! / Refer to protection notice DIN ISO 16016! Keine Änderung ohne Zustimmung der federführenden Konstruktion / Any alterations are subject to the approval of the design department</small>	Bearb./auth.: Hans Peter Schiffert
	Technical Component Requirement Specifications Tail lamp QEV 111 AJPNLG	Abt./dep.: RD/KEL Datum/date: 2022-07-25 Requirement Specifications version: 001 Seite/page: 34 of 220

2123454
FI MH-2761

The lettering shall be applied within the lamp on the reflector/cover frame or other covers.

2123459
FI MH-2868

The client (MB Design) shall define the specifications for the labeling (font, type height, positioning) and provided these to the contractor as a CAD data record (=data control model for interior lighting design).
When designing the tooling concept, a slide shall be taken into account for the labeling.

2123455
FI MH-2763

The dimension is stamped on with a minimum font height of 3 mm and 0.5 mm in depth.

2123456
FI MH-2764

The lettering surface shall be high-gloss; the surface around the lettering shall be matt.

2.1.11.5 Laser Design Name Panel (2753589)

2753598

If the RFQ drawing calls for laser design lettering, the following requirements shall be complied with.

2753599

The client (MB Design) shall define the specifications for the labeling (font, type height, positioning) and provided these to the contractor as a CAD data record (=data control model for interior lighting design).

3214450

The details of the execution shall be definitively agreed upon with the client (MB Design and component manager) by concept review 2.

2.1.11.6 Cover Lens (2123488)

2123491
FI MH-2916

All lens colors have been specified based on the Evonik Röhm GmbH color numbers (see RFQ drawing) with a wall thickness of 2.5 mm.

2123492
FI MH-189

The contractor shall design the lamp so that the cover lens can be created without an optical system.

2123493
FI MH-2520

Elements for geometric visibility are only permitted in the cover lens if proof has been provided in a simulation (concept review 1) and all measures in terms of reflectors or optical lenses have been exhausted. The max. permissible area for optical elements is 0.5 cm² per function. Enlargements are only allowed after the submission of photometric results. Elements for the fulfillment of the geometric visibility are an integral part of the basic offer.

2123495
FI MH-192

The contractor shall design the lamp so that the areas for concealing the welding area (outside and inside the lamp) can have a structured design.

2123497
FI MH-193

The contractor shall agree on the structure for the area for concealing the welding area with the client's Development contact (at the latest by concept review 2).

2123498
FI MH-3039

The structure for concealing the welding area shall be part of the basic offer.

2123501
FI MH-3500

The max. gate diameter of the needle shall be designed in accordance with the component part requirements. This shall be validated by means of filling simulations.

<p>Mercedes-Benz - Confidential -</p>	<p><small>Schutzvermerk DIN ISO 16016 beachten! /Refer to protection notice DIN ISO 16016! Keine Aenderung ohne Zustimmung der federfuehrenden Konstruktion / Any alterations are subject to the approval of the design department</small></p> <p>Technical Component Requirement Specifications Tail lamp QEV 111 AJPNLG</p>	<p>Bearb./auth.: Hans Peter Schiffert Abt./dep.: RD/KEL Datum/date: 2022-07-25 Requirement Specifications 001 version: Seite/page: 35 of 220</p>
---	--	--

The diameter shall be agreed on with MB AG in concept review 2 at the latest with the objective of not exceeding 2.3 mm.

2123502
FI MH-3528

The contractor shall design the cover lens so that the return of the die side is max. 0.2 mm. A protrusion of the die side extending to the nozzle side is not permitted.

2123504
FI MH-2503

Ejector marks on the lens are permitted in the edge area behind the welding rib to the outer edge. The positions shall be disclosed by the milestone concept review 2. The ejector marks shall not be visible at a viewing distance of 1 m. Reference samples will be specified for the first off-tool parts.

2123507
FI MH-2817

The contractor shall design the lens outer edge so that dirt deposits are prevented.

2123506
FI MH-3495

The contractor shall design the lamp so that the distance from the lens edge to the weld zone is max. 2 mm. Deviations shall be disclosed by concept review 1 and be agreed on in the development phase.

2123509
FI MH-3496

In the area of the flank-side "lens tip" (bodyshell contour/lamp wraparound area), the distance from the lens edge to the weld zone may be enlarged to up to 5 mm if this is necessitated for design reasons by the available installation space to the panel. Deviations shall be disclosed by concept review 1 and be agreed on in the development phase.

2123510
FI MH-3529

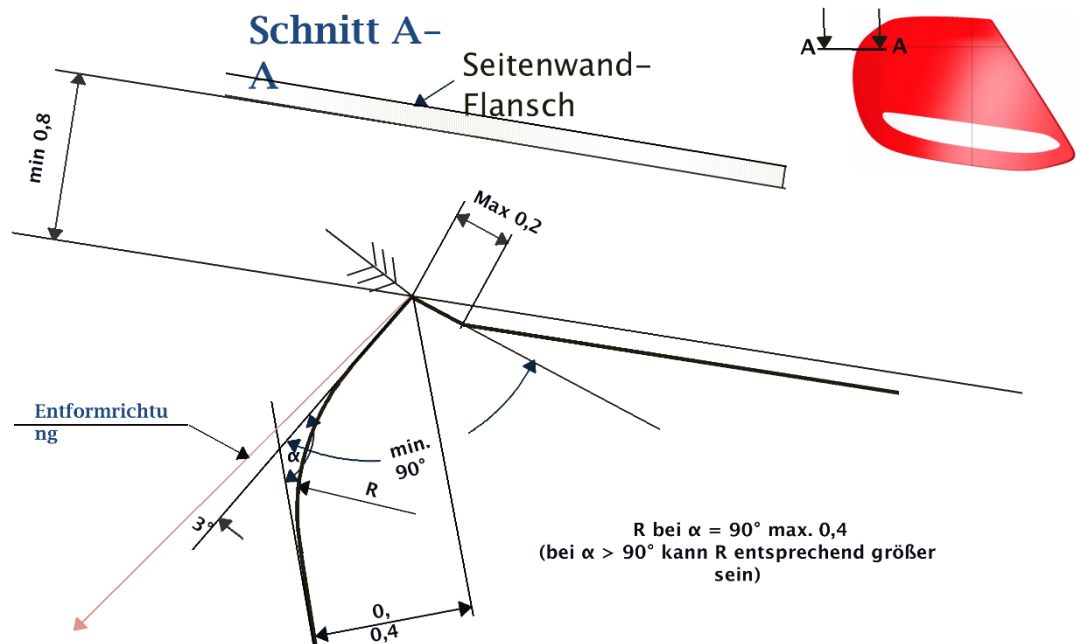

Figure: Guideline for implementing the lens edges.

2123511

The contractor shall design the cover lens so that the angle between the parting plane

Mercedes-Benz - Confidential -	Schutzvermerk DIN ISO 16016 beachten! / Refer to protection notice DIN ISO 16016! Keine Aenderung ohne Zustimmung der federfuehrenden Konstruktion / Any alterations are subject to the approval of the design department	Bearb./auth.: Hans Peter Schiffert Abt./dep.: RD/KEL Datum/date: 2022-07-25
	Technical Component Requirement Specifications Tail lamp QEV 111 AJPNLG	Requirement Specifications 001 version: Seite/page: 36 of 220

FI MH-3323

and lens edge surface is min. 90° all-round.

2123514
FI MH-3516

The contractor shall design the cover lens so that the color separations of the lens are engineered as per the diagram shown.

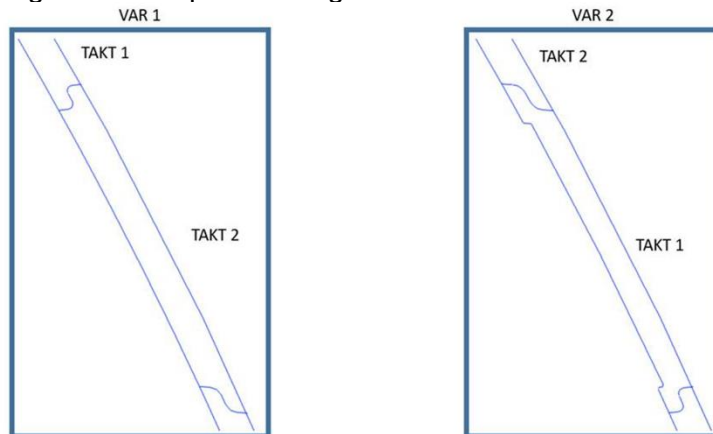

Illumination of protruding or recessed borders/edges shall be prevented. A uniform color impression shall be achieved at the color separation.

2123516
FI MH-2862

The contractor shall design the lamp so that the color separations of the lens are homologation-capable and overshining is prevented.

2123518
FI MH-3411

The contractor shall create the specifications for the color separation contour as a 3D data record based on the client's design data and detailed section investigations incl. a depiction of the optical paths. The data for creation of the data control model (interior design of lamp) shall be provided 5 months before the data control model release for the lighting.

2.1.11.7 Lamp Shroud (2123529)

2.1.11.7.1 General (2123526)

2123533
FI MH-2948

If reflectors are integrated, the contractor shall design the lamp housing so that a decorative ribbing or grain is taken into account in the tooling costs for the reflector base and wall surfaces.

2123531
FI MH-230

The contractor shall minimize the volume of the housing and its subcomponents.

2123534
FI MH-234

The contractor shall design the lamp housing so that an ingress of foreign bodies (e.g. insects) into the lamp is not possible.

2123535
FI MH-2879

According to the tolerance concept, contact surfaces for the self-adhesive spacers/min. gap limiters shall be located on the lamp housing.

2123539
FI MH-2719

The contractor shall design the lamp housing so that it contains a splash guard along the seal (protection of seal against direct exposure to water jet during high-pressure cleaning). The height shall be designed in line with all the tolerance positions occurring. The design shall be disclosed in concept review 2.

Mercedes-Benz - Confidential -	<small>Schutzvermerk DIN ISO 16016 beachten! /Refer to protection notice DIN ISO 16016! Keine Aenderung ohne Zustimmung der federfuehrenden Konstruktion / Any alterations are subject to the approval of the design department</small>	Bearb./auth.: Hans Peter Schiffert Abt./dep.: RD/KEL Datum/date: 2022-07-25 Requirement Specifications 001 version: Seite/page: 37 of 220
	Technical Component Requirement Specifications Tail lamp QEV 111 AJPNLG	

2123540
FI MH-2720

The contractor shall design the lamp housing so that the clearance of all housing parts in the seal area is at least the seal thickness. Grouting of the seal is only permitted in the area around the sealing rib.

2123541
FI MH-3055

The contractor shall design the lamp housing so that the sealing rib has a max. deviation of +/- 0.5 mm relative to the reference system.

2123543
FI MH-2721

The contractor shall design the lamp housing so that all openings in the housing as well as electric/electronic component parts are protected against water ingress due to water possibly dripping onto the lamp (labyrinth, cover, etc.).

2.1.11.7.2 Lettering and Labels (2123590)

2123592
FI MH-3494

The supplier part number may only be applied in non-visible areas (in vehicle assembled condition).

2123594
FI MH-3391

The attachment of the supplier logo in the visible area (in installed condition) is not permitted. Except if legally required.

2123596
FI MH-268

The contractor may not incorporate any cp information on the housing.

2123595
FI MH-2610

The contractor shall agree on the label positioning in accordance with [\[MBN10435\]](#) the client's Development department (by concept review 2 at the latest).

2123598
FI MH-2775

To fulfill the legal requirements, the contractor shall incorporate the voltage and power output data of the light functions on the rear of the lamp housing.

2123603
FI MH-3392

Sample table:

Funktion 1	Spannung 1	Leistung 1
Funktion 2	Spannung 2	Leistung 2
...

2.1.11.7.3 Connection for Bumper Bracket (2123619)

2123624
FI MH-2905

The contractor shall design the sidewall lamp shroud so that up to two integrated mounts for the Z-positioning of the bumper basic bracket can be integrated.

2123621
FI MH-2904

The contractor shall design the sidewall lamp shroud so that a guide for the Y-positioning of the bumper basic bracket can be integrated.

2123623
FI MH-2903

The contractor shall provide for these mounts and/or guides in the tooling concept.

Mercedes-Benz - Confidential -	<small>Schutzvermerk DIN ISO 16016 beachten! /Refer to protection notice DIN ISO 16016! Keine Aenderung ohne Zustimmung der federfuehrenden Konstruktion / Any alterations are subject to the approval of the design department</small>	Bearb./auth.: Hans Peter Schiffert
	Technical Component Requirement Specifications Tail lamp QEV 111 AJPNLG	Abt./dep.: RD/KEL Datum/date: 2022-07-25 Requirement Specifications 001 version: Seite/page: 38 of 220

4210289

The mounts shall be designed such that no forces are introduced into the lamp.

2.1.11.7.4 Color and Surface (2123622)

2123626
FI MH-2588

Surfaces that deviate in color and structure are design elements of the inner design.

2123625
FI MH-2907

MB Design shall specify the surfaces with grain as part of the interior design data generation (DKM=data control model).

2123627
FI MH-3540

The final specification of the surface structures shall be realized for concept review 2. The lamps will be evaluated using off-tool parts.

2123634
FI MH-3533

The contractor shall design all visible surfaces so that they, unless otherwise described, have a high-gloss polished appearance for the subjective observer.

2123631
FI MH-2524

The final specification of the color shall be made in coordination with the client's Design department (at the latest by concept review 2).

2123639
FI MH-2970

The contractor shall design the housing, panels, and reflectors in an opaque color/surface (to be disclosed in concept review 2).

2123636
FI MH-252

The contractor shall optimize the lamp design with regard to process-consistent vapor deposition.

2.1.11.7.5 Molded-On Load Compartment-Side Shroud Panel (2123635)

2123638
FI MH-3430

The contractor shall mold the panel for concealing the load compartment onto the housing of the trunk lid/rear-end door lamp.

2123644
FI MH-259

The contractor shall provide a grain for the load compartment-side panel.

2123641
FI MH-260

The contractor shall agree on the grain of the panel for concealing the load compartment with the client's Development contact and MB "Gray" Design (at the latest by concept review 2).

2123643
FI MH-263

The nominal dimension from the lens to the molded-on panel (joint) shall be < 1 mm.

2123640
FI MH-264

The form surface deviation of the lens from the molded-on panel is:

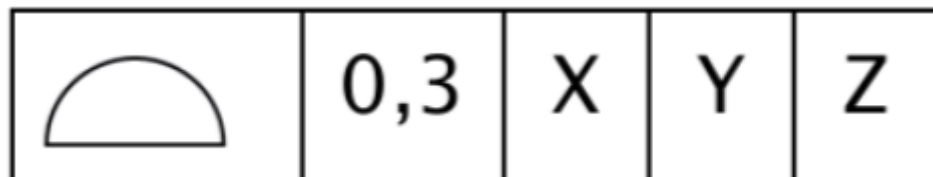

2123642
FI MH-3431

The contractor shall apply the homologation lettering on the panel.

2123646
FI MH-3492

If the molded-on panel is not possible, the contractor shall provide a separate housing panel with corresponding attachment on the lamp housing and take this into account

Mercedes-Benz - Confidential -	<small>Schutzvermerk DIN ISO 16016 beachten! /Refer to protection notice DIN ISO 16016! Keine Aenderung ohne Zustimmung der federfuehrenden Konstruktion / Any alterations are subject to the approval of the design department</small> Technical Component Requirement Specifications Tail lamp QEV 111 AJPNLG	Bearb./auth.: Hans Peter Schiffert Abt./dep.: RD/KEL Datum/date: 2022-07-25 Requirement Specifications 001 version: Seite/page: 39 of 220

in the basic offer.

2.1.11.8 Lamp Housing / Exterior Lamp Lens Connection (2123647)

2123650
FI MH-3071

The connection of the lamp housing with the lens shall be realized by means of a suitable welding method, by means of laser welding if required. Welding burrs shall be minimized.

2123652
FI MH-2915

The welding shall be executed according to the state of the art.

2123656
FI MH-2662

The contractor shall design the lamp so that the protrusion of the lens with respect to the lamp housing is uniform all around.

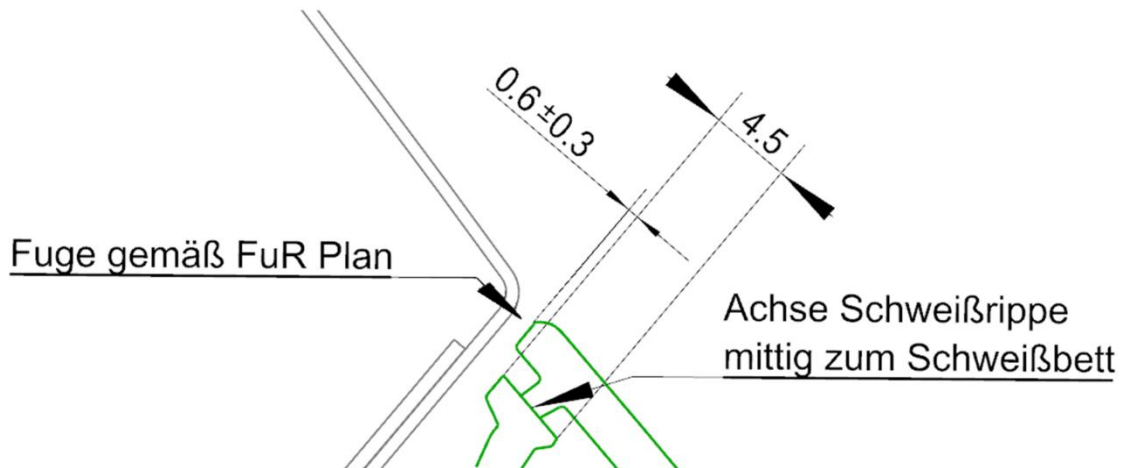

2123655
FI MH-2334

Protruding lens points that are not supported are not permissible as there is a risk of breakage.

2123660
FI MH-2933

The contractor shall design the lamp so that the connection of the lens to the housing is free of tension.

2123661
FI MH-2340

The surfaces shall not be subjected to vapor deposition in areas that are welded.

2.1.11.9 Luggage Compartment Molding on the Lamp (2123664)

3100762

If the RFQ drawing calls for luggage compartment panels on the lamp, the following requirements shall be complied with.

2123662
FI MH-344

The contractor shall provide a grain for the load compartment-side panel.

2123666
FI MH-3151

The contractor shall realize the soft component using the same grain as the hard component.

2123669
FI MH-345

The contractor shall agree on the grain for the load compartment panel with the client's contact from Development and "MB Gray Design".

2123665

The shape of the panel shall be coordinated with the client (MB Development,

Mercedes-Benz - Confidential -	<small>Schutzvermerk DIN ISO 16016 beachten! / Refer to protection notice DIN ISO 16016! Keine Änderung ohne Zustimmung der federführenden Konstruktion / Any alterations are subject to the approval of the design department</small>	Bearb./auth.: Hans Peter Schiffert
	Technical Component Requirement Specifications Tail lamp QEV 111 AJPNLG	Abt./dep.: RD/KEL Datum/date: 2022-07-25 Requirement Specifications version: 001 Seite/page: 40 of 220

FI MH-3148

"MB Gray Design") no later than 8 weeks prior to the start of tool production.

2123667
FI MH-3153

For the feasibility validation, the contractor shall provide the client at the latest 10 weeks before the start of tool production with the CAD data for the creation of samples. (The samples are created by the client himself.)

2123678
FI MH-3550

The nominal dimension of the gap between the molding and the shroud is 0.5 mm. Unless otherwise defined, the contour deviation of the panel in relation to the shroud is:

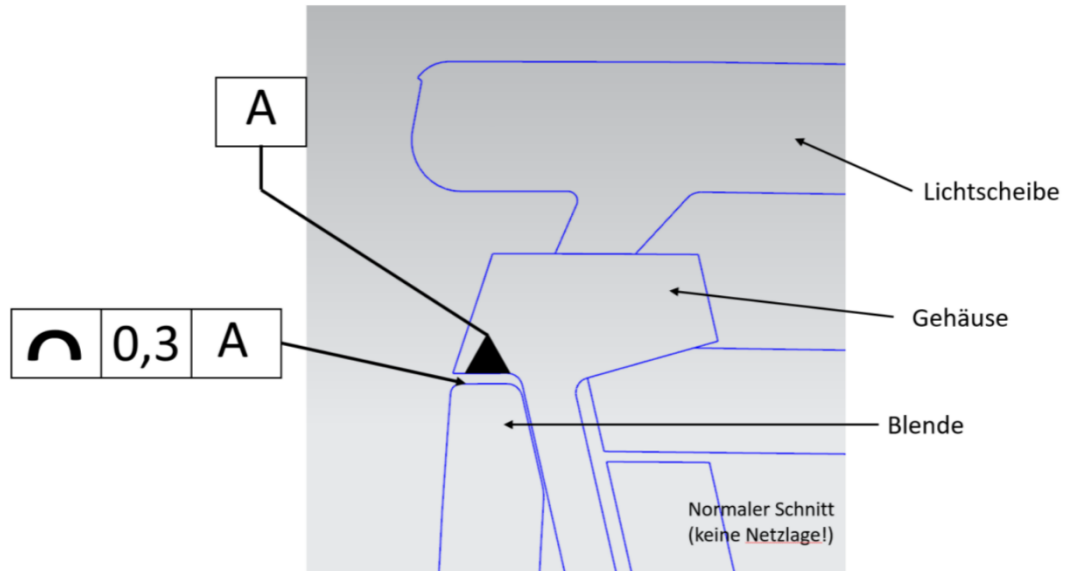

2123679
FI MH-3551

The nominal dimension of the gap between the molding and the lens is 0.5 mm. Unless otherwise defined, the contour deviation of the panel in relation to the lens is:

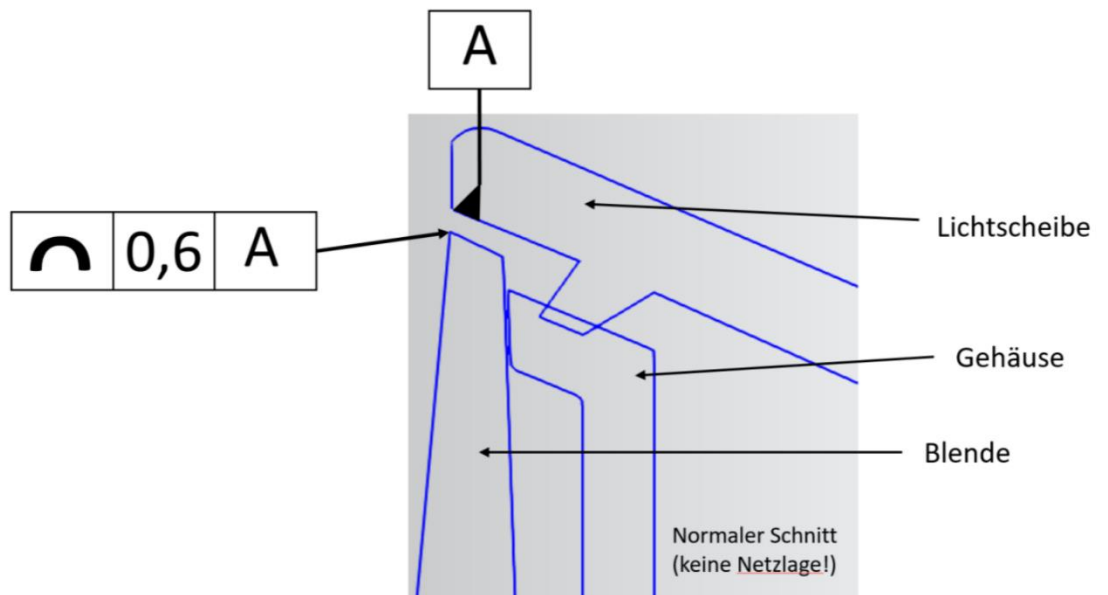

<p>Mercedes-Benz - Confidential -</p>	<p>Schutzvermerk DIN ISO 16016 beachten! /Refer to protection notice DIN ISO 16016! Keine Aenderung ohne Zustimmung der federfuehrenden Konstruktion / Any alterations are subject to the approval of the design department</p> <p>Technical Component Requirement Specifications Tail lamp QEV 111 AJPNLG</p>	<p>Bearb./auth.: Hans Peter Schiffert Abt./dep.: RD/KEL Datum/date: 2022-07-25 Requirement Specifications 001 version: Seite/page: 41 of 220</p>
---	---	--

2123676
FI MH-3545

The contractor shall design the side panel so that the soft component has a positive fit with the adjacent component parts.

2123681
FI MH-3547

The soft component of the 2C panel shall have full contact all round with the bodyshell and in all tolerance positions (incl. seal). The coordination with MB AG shall take place by the time of concept review 2 at the latest.

2123684
FI MH-3501

The tooling concept of the 2C panel shall include an exchangeable insert for the soft component (see diagram). The nominal dimension of the contour of the soft component of the component part geometry is defined in coordination between the contractor and the client. The tooling concept of the exchangeable insert for the soft component shall enable a contour extension in the exchangeable insert of up to 5 mm through repositioning.

2905172

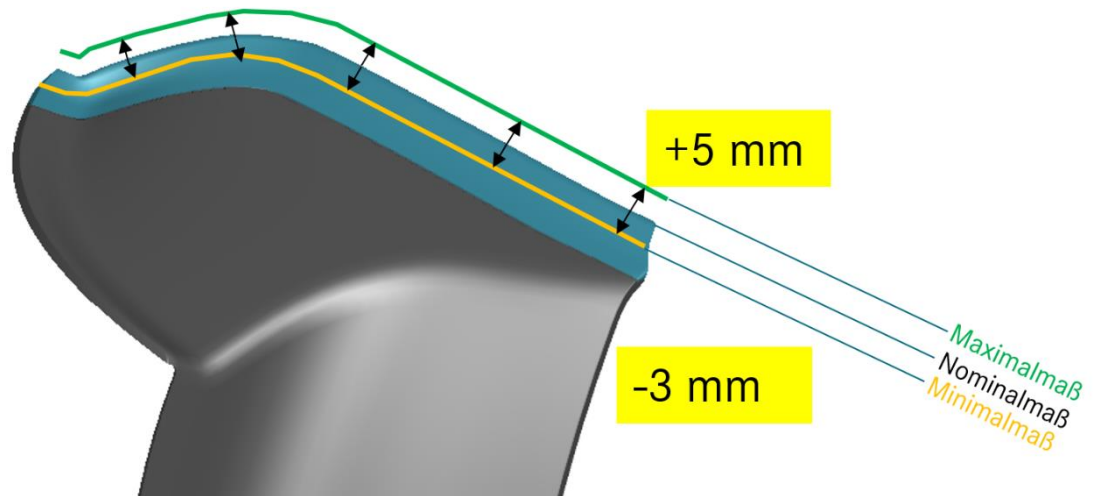

2905173

The tooling concept of the 2C panel shall enable a contour reduction of the soft component of up to 3 mm through recreation of the exchangeable insert.

2905175

The contractor shall present the technical concept for implementation of the exchangeable insert at the concept review 2 milestone. Technical restrictions to the implementation of an exchangeable insert due to the component part geometry shall be disclosed by the contractor and coordinated with the client.

2905176

The measures are used for the final coordination of the soft component with the bodyshell. The client defines whether adjustment of the external geometry of the 2C panel is necessary after completion of the vehicle body of production test 1 at the latest.

2123680
FI MH-353

The load compartment-side panel on the lamp housing shall be permanently connected with the reflector housing.

2123683
FI MH-349

The contractor shall apply the homologation lettering on the panel.

<p>Mercedes-Benz - Confidential -</p>	<p><small>Schutzvermerk DIN ISO 16016 beachten! / Refer to protection notice DIN ISO 16016! Keine Aenderung ohne Zustimmung der federfuehrenden Konstruktion / Any alterations are subject to the approval of the design department</small></p> <p>Technical Component Requirement Specifications Tail lamp QEV 111 AJPNLG</p>	<p>Bearb./auth.: Hans Peter Schiffert Abt./dep.: RD/KEL Datum/date: 2022-07-25 Requirement Specifications 001 version: Seite/page: 42 of 220</p>
---	---	--

2.1.11.10

Additional Lamp Lenses / Optical Lenses (2123688)

2753656

If the RFQ drawing calls for additional lamp lenses/optical lenses, the following requirements shall be complied with.

2123685
FI MH-2516

The contractor shall select and design the method of fastening the additional lamp lens(es)/optical lens(es) so that the connection points are not visible.

2123687
FI MH-2517

The contractor shall implement the additional lamp lens(es)/optical lens(es) with an optical system.

2123686
FI MH-2518

The optical system shall be designed in coordination with the client's Design department (at the latest by concept review 2).

2123689
FI MH-2547

The contractor shall design the additional lamp lens(es)/optical lens(es) so that these have zero clearance and are firmly seated.

2123692
FI MH-2559

If the additional lamp lens(es)/optical lens(es) were subject to vapor deposition, emission of "diffused light" is not permitted (critical-parts overview).

2123691
FI MH-2803

Light may only be emitted in the areas of the additional lamp lens(es)/optical lens(es) defined as the lens aperture (to be disclosed in concept review 2).

2.1.11.11

Reflectors (Additional Reflectors) / Cover Frames (2123690)

2123694
FI MH-288

The contractor shall try to reduce the number of individual reflectors.

2123697
FI MH-3249

If the cover frames/reflectors are subject to vapor deposition, the covers/templates shall be included in the basic offer.

2123696
FI MH-2181

The contractor shall provide a grain structure or rib look on the side boundary areas. Reason: Due to reflections, it can occur that LED spots are reflected multiple times.

2123695
FI MH-3154

The contractor shall design the joints of all lamp component parts to be opaque (labyrinth). No diffused light may be emitted.

2123699
FI MH-2913

The contractor shall design the lamp so that the fasteners of the additional reflectors/cover frames are not visible.

2.1.11.12

Fiber-Optic Cables / Thick-Wall Optics (2123698)

2753660

If the RFQ drawing calls for fiber-optic cables/thick-wall optics, the following requirements shall be complied with.

2123702
FI MH-2035

The contractor shall design the fiber-optic cables/thick-wall optics so that no spotlights are visible in the illuminated status.

2123703
FI MH-2489

The contractor shall design the areas of the light feed so that the flash points of the LEDs are not visible.

Mercedes-Benz - Confidential -	<small>Schutzvermerk DIN ISO 16016 beachten! / Refer to protection notice DIN ISO 16016! Keine Aenderung ohne Zustimmung der federfuehrenden Konstruktion / Any alterations are subject to the approval of the design department</small>	Bearb./auth.: Hans Peter Schiffert
	Technical Component Requirement Specifications Tail lamp QEV 111 AJPNLG	Abt./dep.: RD/KEL Datum/date: 2022-07-25 Requirement Specifications version: 001 Seite/page: 43 of 220

2123700
FI MH-2526

The contractor shall design the lamp so that the fasteners for securing the fiber-optic cables/thick-wall optics are not visible in the illuminated and non-illuminated status.

2123701
FI MH-310

The contractor shall design the fiber-optic cables/thick-wall optics so that the outlets and boundaries are precisely illuminated.

2123704
FI MH-3163

The contractor shall design the fiber-optic cables/thick-wall optics so that the faces can be provided with an optical structure.

2.1.11.13 Rear Reflectors / Side Reflectors (2123707)

2753662

If the RFQ drawing calls for rear reflectors/side reflectors, the following requirements shall be complied with.

2123708
FI MH-320

The contractor shall agree on the photometric simulations of the reflector and side reflector with the electroforming manufacturer before the start of tool production.

2123705
FI MH-321

The contractor shall present the photometric simulations of the reflector and side reflector to the client's Development contact (at the latest by concept review 1).

2123709
FI MH-2953

If the rear and side reflector are not integrated in the lens, the fasteners of the rear and side reflector shall not be visible.

2.1.11.14 Seals (2123710)

2123712
FI MH-3416

The contractor shall seal all openings in the bodyshell that are in the lamp engagement area against water, dust, and other foreign bodies.

2123714
FI MH-3525

The contractor shall design the lamp so that a sealing surface with constant transitions is generated and complete covering of the seal is ensured.

2123718
FI MH-3499

The contractor shall design the lamp so that a uniform sealing effect is achieved.

2123717
FI MH-362

The contractor shall take into account the unit pressure and bodyshell tolerances in the sealing with respect to the body.

2123716
FI MH-2072

The contractor shall not assume that the attachment surface for the lamp is ideally rigid. Reason: The bodyshell elasticity shall be taken into account for the seal design.

2123715
FI MH-368

The contractor shall submit the force simulation for the seal design to the client's Development contact in concept review 2.

2123719
FI MH-364

The contractor shall design the seals so that they do not detach during transport in the load container.

2123723
FI MH-365

The contractor shall design the seals so that they do not detach, twist, or become stuck during assembly.

2123724
FI MH-2716

If the fastening holes on the bodyshell have been made using STF&P, the contractor shall design the seals so that the leaktightness complies with the Chapter "Test Specifications for all Parts of the Sourcing Scope".

<p>Mercedes-Benz - Confidential -</p>	<p style="font-size: small;">Schutzvermerk DIN ISO 16016 beachten! /Refer to protection notice DIN ISO 16016! Keine Aenderung ohne Zustimmung der federfuehrenden Konstruktion / Any alterations are subject to the approval of the design department</p> <p style="text-align: center;">Technical Component Requirement Specifications Tail lamp QEV 111 AJPNLG</p>	<p>Bearb./auth.: Hans Peter Schiffert Abt./dep.: RD/KEL Datum/date: 2022-07-25 Requirement Specifications 001 version: Seite/page: 44 of 220</p>
---	---	--

2.1.11.14.1 Sponge Rubber / Plate Seals (2123722)

- 2753663 If the RFQ drawing calls for a sponge rubber/plate seal, the following requirements shall be complied with.

- 2123720 FI MH-3170 The contractor shall design seals made out of closed-cell cellular rubber material.

- 2123721 FI MH-360 The contractor shall design the seals so that they are self-adhesive on one side.

- 2123725 FI MH-3189 The seal thickness for the rear-end door lamp shall be designed to be at least 6 mm

- 2123728 FI MH-3504 The contractor shall design the seal compression to be 50% and ensure the system leaktightness, as described in the Chapter "Test Specifications for all Parts of the Sourcing Scope".

- 2123726 FI MH-2722 The contractor shall design the fastening concept of the lamp so that compaction of the seals used is possible up to 70% around the perimeter.

2.1.11.14.2 TPE Ring Seal (2123727)

- 2753666 If the RFQ drawing calls for a TPE ring seal, the following requirements shall be complied with.

- 2123732 FI MH-366 Cross-section diagram of TPE ring seal

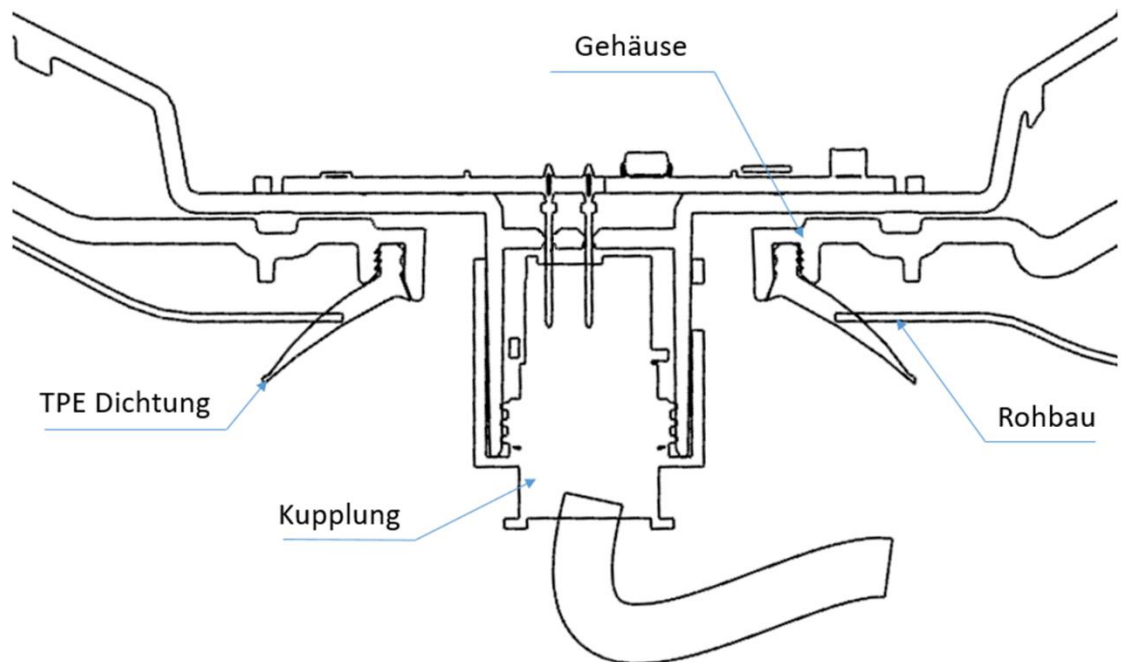

- 2123730 FI MH-3423 The contractor shall design the seals so that a minimum compression of 2.6 mm is achieved.

Mercedes-Benz - Confidential -	<small>Schutzvermerk DIN ISO 16016 beachten! /Refer to protection notice DIN ISO 16016! Keine Aenderung ohne Zustimmung der federfuehrenden Konstruktion / Any alterations are subject to the approval of the design department</small> Technical Component Requirement Specifications Tail lamp QEV 111 AJPNLG	Bearb./auth.: Hans Peter Schiffert Abt./dep.: RD/KEL Datum/date: 2022-07-25 Requirement Specifications version: 001 Seite/page: 45 of 220

2123733
FI MH-2663

The contractor shall design the seals so that they are fastened to the housing and are secured against falling off.

2.1.11.14.3 TPE Edge Seal (2123734)

2753881

If the RFQ drawing calls for a TPE edge seal, the following requirements shall be complied with.

2123735
FI MH-3493

The contractor shall design the trunk lid/rear-end door lamp so that it has an edge seal. This does not apply to continuous reflector strips. Offer in accordance with RFQ drawing.

2123739
FI MH-3524

The edge seal shall lie against the bodyshell and interrupts the open jet of the water jet test to the EPDM sealing plate.

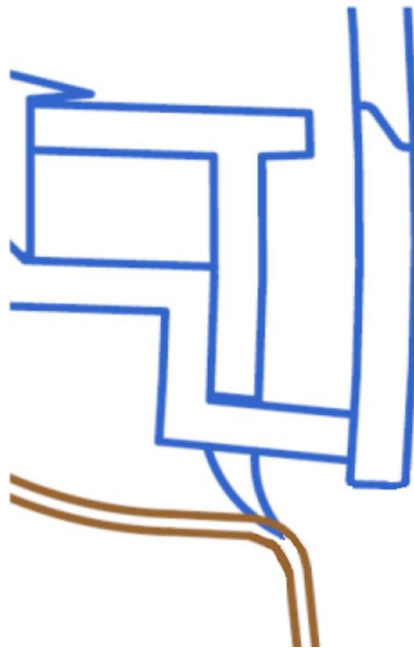

3057336

The edge seal shall not be visible in the installed condition.

2123740
FI MH-3247

The edge seal shall be designed so that it complies with the requirements from Chapter "FI Testing of the Rear". (Including manual high-pressure steam jet cleaning.)

2.1.11.15 LED PCBs (2123748)

2123746
FI MH-2630

The contractor shall design the lamp so that the lettering on the PCBs is not visible in the installation position and under the standard viewing direction.

2123749
FI MH-3413

Normal direction of vision at close range means: direction of vision above a height of 1.5 m at a distance of 0 – 5 m from the lamp. If it is not possible for design reasons, coordination is required and a reference sample shall be constructed (at the latest by concept review 2).

<p>Mercedes-Benz - Confidential -</p>	<p><small>Schutzvermerk DIN ISO 16016 beachten! /Refer to protection notice DIN ISO 16016! Keine Aenderung ohne Zustimmung der federfuehrenden Konstruktion / Any alterations are subject to the approval of the design department</small></p> <p>Technical Component Requirement Specifications Tail lamp QEV 111 AJPNLG</p>	<p>Bearb./auth.: Hans Peter Schiffert Abt./dep.: RD/KEL Datum/date: 2022-07-25 Requirement Specifications 001 version: Seite/page: 46 of 220</p>
---	--	--

2123745
FI MH-411

The contractor shall design the lamp so that the LED PCBs are permanently secured in a suitable manner with the reflector insert. While driving, there shall be no noise development or abrasion in visible areas.

2123747
FI MH-412

The contractor shall design the lamp so that cooling is provided if required for the LEDs. This shall be disclosed in the basic offer.

2123750
FI MH-429

The contractor shall design the lamp so that the LED PCBs are not under stress in the assembled status.

2.1.11.16

Molding on Lamp (2123751)

2123752
FI MH-2550

If the RFQ drawing calls for an outer molding, the following requirements shall be complied with.

2123754
FI MH-2845

The trim strip shall have an adhesive anti-noise strip on one side.

2123753
FI MH-3053

The adhesive tape shall not be visible from the outside in the installed condition.

2123755
FI MH-2579

No noises (e.g. creaking) shall be caused by the molding.

2123759
FI MH-2578

The molding shall not rub on the tail lamp and shall not produce abrasion.

2123758
FI MH-2580

The molding shall be fixed and mounted with zero clearance on the rear lamp.

2123757
FI MH-2576

There shall be no quality defects, such as sunk spots, apparent on the visible side of the molding.

2123756
FI MH-2577

The trim strip shall be hung-in at the tail lamp.

2123764
FI MH-2552

Should any adjacent moldings also have the same surface as the molding (e.g. chrome-plated), the choice of supplier for the surface manufacturer shall be agreed jointly with the client.

2123761
FI MH-2555

If the molding is chrome-plated (see RFQ drawing), the surface shall comply with DBL1665.

3302536

The supplier/contractor show a changeover scenario regarding how a chromium-(VI)-free chromium plating process can be realized from 09/2024 (REACH-compliant process).

3302537

The production locations for chrome-plated component parts shall be indicated. The use of laminated surfaces shall be evaluated and indicated accordingly.

3302538

The layer thickness shall be documented in the drawing.

3302539

The color code for bright chrome in chrome (III) can be found in the parts list.

<p>Mercedes-Benz - Confidential -</p>	<p><small>Schutzvermerk DIN ISO 16016 beachten! / Refer to protection notice DIN ISO 16016! Keine Aenderung ohne Zustimmung der federfuehrenden Konstruktion / Any alterations are subject to the approval of the design department</small></p> <p>Technical Component Requirement Specifications Tail lamp QEV 111 AJPNLG</p>	<p>Bearb./auth.: Hans Peter Schiffert Abt./dep.: RD/KEL Datum/date: 2022-07-25 Requirement Specifications 001 version: Seite/page: 47 of 220</p>
---	---	--

2.1.11.17

Self-Adhesive Component Parts (2123762)

2123763
FI MH-2583

All self-adhesive component parts shall comply with [DBL 7906].

2123765
FI MH-2584

If the bonded component has to be dismantled again, no adjacent component parts may be damaged.

2123768
FI MH-3498

It shall be possible to remove the adhesive residues for a re-bonding process without function impairment.

2123769
FI MH-2587

The bonding shall not permanently damage the bonding surface on the opposite side.

2.1.12

Mechanical System Testing and Validation (2123767)

2.1.12.1

In-Series Measurements (2123819)

2123818
FI MH-1617

The contractor shall perform an automatic 100% function test (incl. current consumption of light sources) during lamp production.

2123817
FI MH-1618

The contractor shall visibly mark the lamp after the successfully passed function test.

2123824
FI MH-1619

The contractor shall perform an automatic 100% test for the presence of all parts during lamp production.

2123821
FI MH-1620

The contractor shall perform a 100% leak test during lamp production and visibly mark the lamp after a successfully passed test.

2123828
FI MH-3517

The contractor shall coordinate the number and location of the measuring points with the client's Development contact. The number of measuring points can be found in the other applicable document "Process Requirement Specifications Quality, PLH". For analysis purposes, additional measuring points such as the spacer position or bumper holder position can be required in the CMM measurement. These shall be agreed on with the client.

2123826
FI MH-3531

The supplier shall check and statistically evaluate the specified geometric measuring points "inline" during the production of the lamps.

2123827
FI MH-2166

The in-line measurement represents the 100% inspection of all lamps during production.

2123833
FI MH-2709

Manufacturing defects of any kind that adversely affect function and appearance are not acceptable.

2123832
FI MH-1622

The contractor shall automatically transfer out "not OK parts" during lamp production.

2.1.12.2

CIP (2123837)

2123839

The continuous acquisition and analysis of required values and actual values shall be

Mercedes-Benz - Confidential -	<small>Schutzvermerk DIN ISO 16016 beachten! / Refer to protection notice DIN ISO 16016! Keine Aenderung ohne Zustimmung der federfuehrenden Konstruktion / Any alterations are subject to the approval of the design department</small>	Bearb./auth.: Hans Peter Schiffert
	Technical Component Requirement Specifications Tail lamp QEV 111 AJPNLG	Abt./dep.: RD/KEL Datum/date: 2022-07-25 Requirement Specifications 001 version: Seite/page: 48 of 220

FI MH-1511 performed, the resulting improvements introduced.

2.1.12.3 Certification/Homologation (2123840)

2123842
FI MH-3510 The contractor shall fulfill the general requirements in the Chapter "Certification / Type Approval" in the Common Requirements [LHV 310 00x].

2123841
FI MH-3502 All homologation marks and approval markings shall be visible in or on the lamp and be disclosed by concept review 1.

2.1.12.3.1 Time Frame (2123847)

2123849
FI MH-2382 *In addition to the milestones defined in the Common Requirements [LHV 310 001], all certification-relevant data, documents, and objective evidence shall be provided in accordance with the data requirements in the "CERTUS" system 4 weeks before the PPAR deadline at the latest.*

2.1.13 Requirements Derived from the Electronics (2124736)

2.1.13.1 General (2124737)

2124734
FI_EE-1787 *This chapter contains all information on the electrical and electronic requirements for lamps for MB vehicles.*

2124735
FI_EE-1788 *Therefore, the focus is on the description of the properties, interfaces and components used.*

2.1.13.1.1 Functional Safety (2124738)

2124740
FI_EE-3835 The requirements for functional safety in accordance with [\[ISO 26262\]](#) shall be fulfilled.

2124739
FI_EE-3911 The functional reliability contact can be found in the "Contacts and Responsibilities" Chapter.

2124742
FI_EE-3962 The supplier shall submit the self-disclosure form for functional safety in accordance with [\[ISO 26262\]](#) with the submission of an offer.

2124741
FI_EE-3978 The supplier shall appoint a FuSi manager with the submission of a tender.

2124743
FI_EE-3963 The system requirements, including the diagnosis quality, are provided in a separate module.

2124745
FI_EE-4144 The system requirements, including the diagnosis quality, are confirmed by the contractor with the submission of an offer.

2124748
FI_EE-4145 The contractor shall submit an interface agreement ("DIA" – Development Interface Agreement) that is filled out and coordinated with the client for concept review 1.

Mercedes-Benz - Confidential -	<small>Schutzvermerk DIN ISO 16016 beachten! /Refer to protection notice DIN ISO 16016! Keine Aenderung ohne Zustimmung der federfuehrenden Konstruktion / Any alterations are subject to the approval of the design department</small>	Bearb./auth.: Hans Peter Schiffert
	Technical Component Requirement Specifications Tail lamp QEV 111 AJPNLG	Abt./dep.: RD/KEL Datum/date: 2022-07-25 Requirement Specifications 001 version: Seite/page: 49 of 220

2124746
FI_EE-3964

By concept review 2, the contractor shall present the complete proof of compliance with the requirements (e.g. by FMEAs, error calculations, etc.).

2.1.13.1.2

E-E Coordination Document (2124744)

2124747
FI_EE-3943

The E-E coordination document is a binding document concerning the E-E requirements, which shall be used as an exchange document between the supplier and MB from the kick-off to the green release.

2124750
FI_EE-3956

The supplier is responsible for the up-to-datedness and content with regard to the lamp.

2124752
FI_EE-3957

Every change has to be noted in the history with the date, description and page number.

2963014

Furthermore, the supplier shall include the current date and the supplier name in the file name.

2963015

The MB contact shall then be informed of the change immediately.

2124751
FI_EE-3944

The following shall be maintained by the supplier in the E-E coordination:

2963017

Supplier contact (name, phone number email)

2963018

Central connector pinning

2963019

Type (implementation regulation) of plug connection (central connector) including coding and variant description.

2963021

Wiring concept (interconnection of the individual circuit boards) for each variant

2963066

Function description of every light function (electrical parameters, illuminants, registration type, wiring diagram, etc.)

2963067

Information on the dynamic light sequence (e.g. designation of the GUI file, dynamic light sequence duration, etc.) if there is one.

2124756
FI_EE-4125

For all circuits that contain microcontrollers, the software statuses shall be documented (PCB numbers of μ C, date, version number, supplier designation).

2.1.13.1.3

E-E Drawing Content (2124763)

2124764
FI_EE-3826

The E-E drawing (Sheet m) shall contain the items listed in the following:

2124766
FI_EE-3827

Wiring concept (interconnection of the individual circuit boards) for each variant

2124765
FI_EE-3828

Electric wiring diagrams of all functions, fully labeled with units

2963068

For all circuits that contain microcontrollers, the software statuses shall be documented (PCB numbers of μ C, date, version number, supplier designation).

Mercedes-Benz - Confidential -	<small>Schutzvermerk DIN ISO 16016 beachten! /Refer to protection notice DIN ISO 16016! Keine Aenderung ohne Zustimmung der federfuehrenden Konstruktion / Any alterations are subject to the approval of the design department</small>	Bearb./auth.: Hans Peter Schiffert Abt./dep.: RD/KEL Datum/date: 2022-07-25 Requirement Specifications 001 version: Seite/page: 50 of 220
	Technical Component Requirement Specifications Tail lamp QEV 111 AJPNLG	

2124768
FI_EE-3830

Image of the plug connection (central connector) including coding and variant description

2124770
FI_EE-3831

Central connector pinning

2124771
FI_EE-3832

Table with traffic variants (e.g. ECE/SAE; with rear fog lamp/without rear fog lamp)

2124769
FI_EE-3833

Connections table (pins, coding, implementation regulation, connector numbers)

2124772
FI_EE-3834

Table: Electrical characteristics

- Illuminants (number, precise designation)
- Output per function
- Operating voltage range
- Registration voltage
- Multi-level function registration voltage (high level, mid level, low level)
- Amperage (Imin, Ityp, Imax)
- LED characteristics (color bin, brightness bin, current feed from the LED)
- Failure detection in lamp yes/no

2.1.13.1.4

Service Life (2124773)

2124778
FI_EE-4069

The component part shall be designed so that the full functionality is ensured for at least 9,000 operating hours.

2124775
FI_EE-1093

The table has been designed for 15 years and is adjusted for daytime driving mode or where daytime running lamps are mandatory.

The respective function shall be designed for the service life listed in the table at minimum.

Designation	Switch-on time [h]	Number of cycles
Terminal 15 ON, engine running	9,000	54,000
Tail light, left and right	9,000	54,000
Stop lamp, left and right	1,467	1,800,000
Turn indicator, left and right	500	2,700,000
Reversing light, left and right	74	74,400
Rear fog lights, left/right/center	74	74,400
Side markers, left and right	9,000	54,000
3rd tail lamp	1,467	1,800,000
License plate lamp, left/right/center	9,000	54,000

Mercedes-Benz - Confidential -	<small>Schutzvermerk DIN ISO 16016 beachten! /Refer to protection notice DIN ISO 16016! Keine Aenderung ohne Zustimmung der federfuehrenden Konstruktion / Any alterations are subject to the approval of the design department</small>	Bearb./auth.: Hans Peter Schiffert
	Technical Component Requirement Specifications Tail lamp QEV 111 AJPNLG	Abt./dep.: RD/KEL Datum/date: 2022-07-25 Requirement Specifications version: 001 Seite/page: 51 of 220

2.1.13.2 Electronics Properties (2124777)

2.1.13.2.1 Contact System Features (2124776)

2124774
FI_EE-3837 The connection requirements are described in the implementation regulation [\[A2210002699\]](#) and shall be complied with.

2124780
FI_EE-3932 The test specifications [\[MBN 10384\]](#) / [\[LV 214\]](#) shall be fulfilled.

2.1.13.2.1.1 Mechanical/Design Features (2124783)

2124779
FI_EE-102 The supplier shall ensure that the contact systems are not damaged on delivery.

2124781
FI_EE-103 The supplier shall ensure that the contact systems are not soiled on delivery.

2124782
FI_EE-3714 None of the plugs of plug connections may have any burrs.

2124784
FI_EE-106 Plugging reliability of the plugs shall be ensured at all times.

2124788
FI_EE-107 The form fitting of the connectors shall be ensured at all times.

2124785
FI_EE-3718 Faulty or incorrect assembly shall be ruled out. If incorrect assembly or misuse occurs despite this, no electrical connection shall be established.

2124787
FI_EE-114 The contact support parts shall be engaged directly with each other (not via "third component parts").
Reason: minimum clearance of the contact surfaces is to be achieved.

2124786
FI_EE-115 The supplier shall design the cable cross-section in the lamp according to the current consumption and coordinate this with the client.

2124790
FI_EE-4130 Internal connectors shall be secured in a positive-locking manner against twisting, tilting, detachment, etc. (Positive engagement arises via the interlocking of two components; in this connection, the components can also not detach without force application).

2.1.13.2.1.2 Contact Material Features (2124789)

2124792
FI_EE-119 The supplier shall have the contact surfaces tin-plated. Identical material pairing with the counterpart (e.g. tin/tin).

2124791
FI_EE-123 The contact-bearing material must be CuNiSi.

2.1.13.2.1.3 Other Features (2124801)

2124803 The connectors shall not char after an operating period of 15 years in the vehicle.

Mercedes-Benz - Confidential -	<small>Schutzvermerk DIN ISO 16016 beachten! / Refer to protection notice DIN ISO 16016! Keine Änderung ohne Zustimmung der federführenden Konstruktion / Any alterations are subject to the approval of the design department</small>	Bearb./auth.: Hans Peter Schiffert
	Technical Component Requirement Specifications Tail lamp QEV 111 AJPNLG	Abt./dep.: RD/KEL Datum/date: 2022-07-25 Requirement Specifications version: 001 Seite/page: 52 of 220

FI_EE-140

2124799
FI_EE-141

After 15 years of operation in the motor vehicle, plastics must not melt.

2124800
FI_EE-142

After 15 years of operation in the motor vehicle, there must be no contact corrosion.

2124802
FI_EE-143

After 15 years of operation in the motor vehicle, there must be no pitting at the contact surfaces.

2124805
FI_EE-144

After 15 years of operation in the motor vehicle, contacts not connected must not be scorched or heated up under voltage.

2.1.13.2.2 Voltages and Currents (2124808)

2.1.13.2.2.1 Voltage Range (2124804)

2124807
FI_EE-170

The voltage values are those values measured at the terminals of the lamp.

2124806
FI_EE-171

The supplier shall coordinate the actual voltage values during the development process with the client (E-E slides) and, after their final definition, or at the latest by the green release, document them on the drawing.

2124809
FI_EE-3721

On-board voltage range

Voltage range within which the on-board electrical system of the component may fluctuate

2124812
FI_EE-174

Operating voltage range

Voltage range at the component within which the function (recognizable signal representation, no failure of individual ranges) is ensured.

2124810
FI_EE-2867

Diagnostic voltage range

Voltage range at the component for which a diagnosis must be ensured.

2124811
FI_EE-175

Test voltage

Voltage for the photometric homologation at which the light values of the corresponding function must be fulfilled.

If a voltage range is specified, the test voltage shall still be defined in coordination with the client in order that the light values are complied with and the vehicle has a harmonious appearance.

2124813
FI_EE-2860

Standard voltage values:

Designation	Symbol	Min. value	typ. Value	Max. value	Unit
On-board voltage range	U _{Bat}	6	-	17	V
Operating voltage range	U _B	8	-	17	V
Voltage of logical functions	UL	8	-	17	V
Diagnostic voltage range	U _D	8	-	17	V
Test voltage of the light functions	U _{Typ}	-	12.8	-	V

Mercedes-Benz - Confidential -	<small>Schutzvermerk DIN ISO 16016 beachten! /Refer to protection notice DIN ISO 16016! Keine Aenderung ohne Zustimmung der federfuehrenden Konstruktion / Any alterations are subject to the approval of the design department</small> Technical Component Requirement Specifications Tail lamp QEV 111 AJPNLG	Bearb./auth.: Hans Peter Schiffert Abt./dep.: RD/KEL Datum/date: 2022-07-25 Requirement Specifications 001 version: Seite/page: 53 of 220

3559497

Exception is the reversing light with 3 LEDs in series:

Designation	Symbol	Min. value	typ. Value	Max. value	Unit
On-board voltage range	U _{Bat}	6	-	17	V
Operating voltage range	U _B	8	-	17	V
Voltage of logical function	U _L	10	-	17	V
Diagnostic voltage range	U _D	11	-	17	V
Test voltage of light function	U _{Typ}	-	12.8	-	V

2124817
FI_EE-2135

As a general rule, a test voltage of 12.8 V is specified for each light function (see Table: Standard voltage values).

2124815
FI_EE-3941

If technical or certification-relevant reasons make it necessary to deviate from this test voltage, this shall be agreed on with the MB contact.

2.1.13.2.2.2 Current Consumption (2124814)

2124816
FI_EE-3845

All current values apply for the diagnostic voltage range for temperatures between T_{min} and T_{max} (see E-E coordination slides)

2.1.13.2.2.2.1 Current Consumption of the Supply Line (3037631)

3037635

The current consumption of the supply line in a sidewall lamp/trunk lid lamp/continuous reflector strip shall be below 5 A.

2.1.13.2.2.2.2 Switch-on Currents (2124832)

2124833
FI_EE-3848

To prevent too-high switch-on currents, the capacity at the power supply inputs of the lamp shall not exceed 100 µF.

2.1.13.2.2.2.3 Leak Currents from the Vehicle (2124838)

2124834
FI_EE-3853

Leakage currents up to 200 µA shall not result in illumination/flashing of the function. They must be absorbed within the lamp.

2.1.13.2.2.3 Documentation of the Key Data and the Corresponding Documents (2124837)

2124835
FI_EE-223

The supplier shall maintain the voltages and currents for the light functions in the E-E slides and document the final status on the drawing.

2124836
FI_EE-3855

The supplier shall maintain the cycle ratio (for PWM) for the light functions in the E-E slides and document the final status on the drawing.

2124843
FI_EE-9

The supplier shall make the electrical data of the component for the operating voltage range and the operating temperature available to the contact from the client's development department.

Mercedes-Benz - Confidential -	<small>Schutzvermerk DIN ISO 16016 beachten! /Refer to protection notice DIN ISO 16016! Keine Aenderung ohne Zustimmung der federfuehrenden Konstruktion / Any alterations are subject to the approval of the design department</small>	Bearb./auth.: Hans Peter Schiffert Abt./dep.: RD/KEL Datum/date: 2022-07-25 Requirement Specifications 001 version: Seite/page: 54 of 220
	Technical Component Requirement Specifications Tail lamp QEV 111 AJPNLG	

2124842
FI_EE-6 The supplier shall make the fully labeled circuit diagram of the electronic lamp component available to the contact from the client's development department.

2124840
FI_EE-3910 The supplier shall make the fully labeled circuit board layout of the electronic lamp component available to the contact from the client's development department.

2.1.13.2.2.4 In-Line Testing during Series Production (2124839)

2124841
FI_EE-3857 The supplier shall check the light functions for individual light source failures using in-line testing.

2124848
FI_EE-3930 The supplier shall use measurements/tests to ensure that all component parts are installed in line with the specifications and that all circuit parts are fulfilling their function. The corresponding concept shall be disclosed to MB.

2869740 The supplier shall check the communications interface (e.g. CRC check)

3079429 The supplier shall check the tail light emergency light. For this purpose, the communications interface shall be interrupted and the corresponding light sources shall light up when the power supply (terminal 30) is active.

2974521 The supplier shall check the memory content of the LED drivers with regard to its correctness.

2974522 The supplier shall check the function of the BL redundancy line. For this purpose, active actuation shall take place on the BL redundancy line after interruption of the communications interface and the corresponding light sources shall light up.

3079430 An inspection log shall be created for every checked light. The content of the inspection log shall be coordinated with MB.

2.1.13.2.3 Thermal Management (3220562)

3220563 The contractor shall perform temperature simulations on the electronics of the component part based on the requirements in Chapter "Requirements from Testing".

3220565 These shall be agreed on with the client by concept review 2 at the latest.

4231424 4 weeks after off-tool parts, the temperature simulations shall be confirmed based on measurements of real parts.

2.1.13.2.4 Routing of Lines (2124846)

2124849
FI_EE-2855 All electrical lines shall fulfill the tests as per [\[MBN LV 112-1\]](#).

2124852
FI_EE-247 The supplier shall design the installation of the cables in such a way that any chafing of cables is not possible.

2124853
FI_EE-248 The lines shall be fastened mechanically.

Mercedes-Benz - Confidential -	<small>Schutzvermerk DIN ISO 16016 beachten! /Refer to protection notice DIN ISO 16016! Keine Aenderung ohne Zustimmung der federfuehrenden Konstruktion / Any alterations are subject to the approval of the design department</small>	Bearb./auth.: Hans Peter Schiffert
	Technical Component Requirement Specifications Tail lamp QEV 111 AJPNLG	Abt./dep.: RD/KEL Datum/date: 2022-07-25 Requirement Specifications 001 version: Seite/page: 55 of 220

- 2124850
FI_EE-4142 Plastic clips shall be used for line attachment.
- 2124851
FI_EE-3933 The use of splices is not permitted.
- 2124857
FI_EE-249 The lines shall not be visible through the cover plate.
- 2124856
FI_EE-250 The lines shall not be visible through the gap
- 2124855
FI_EE-251 The lines shall not be visible when the trunk lid is open
- 2124854
FI_EE-252 The supplier shall combine cables with a length ≥ 10 cm with a suitable cable covering or secure them to a suitable component part. In this connection, it shall be ensured that the cable is neither damaged (e.g. chafing, kinking, etc.) nor slips.
- 2124858
FI_EE-253 The supplier shall optimally design the line routing with regard to EMC aspects.

2.1.13.2.5 Printed Circuit Board (2124861)

- 2124860
FI_EE-256 If fastened to the housing base, the PCB must not be positioned at the lowest point to be protected from stagnant moisture.
- 2124863
FI_EE-3928 Moisture on the circuit board, e.g. as a result of condensation, shall not impair the circuit.
- 2124862
FI_EE-1429 In the case of safety-relevant components, no signal conductors may be routed under ceramic capacitors.

2.1.13.2.6 Requirements for Electronic Component Parts (2124859)

- 2124865
FI_EE-1410 Electronic component parts shall be qualified according to AEC-Q (100/101/200).
- 2124864
FI_EE-3912 In order to prevent the silver corrosion of LEDs, either LEDs with silver-lead frames + resin grouting or LEDs with gold-lead frames may be used.
- 2124866
FI_EE-3861 Only those component elements may be used for which it has been ascertained that their use entails no risk in the vehicle as far as mission profile (component specification), workmanship (processing procedure and/or parameters), and service life are concerned and that they are suitable for vehicle use.
- 2124867
FI_EE-3862 It shall be ensured that the failure of a component element cannot lead to irreparable thermal damage to the component.
- 2124868
FI_EE-3863 Further development rules are contained in the Implementation Regulation: Design Rules for E/E Components, External Version [\[MBN 10463\]](#), and these shall be taken into consideration.

Mercedes-Benz - Confidential -	Schutzvermerk DIN ISO 16016 beachten! / Refer to protection notice DIN ISO 16016! Keine Aenderung ohne Zustimmung der federfuehrenden Konstruktion / Any alterations are subject to the approval of the design department	Bearb./auth.: Hans Peter Schiffert Abt./dep.: RD/KEL Datum/date: 2022-07-25 Requirement Specifications 001 version: Seite/page: 56 of 220
	Technical Component Requirement Specifications Tail lamp QEV 111 AJPNLG	

2.1.13.2.7 General ESD Requirements (3229632)

- 3229642 All vapor-deposited parts and reflectors within the lamp shall be connected with low resistance (< 10 ohms) to ground.
- 3229643 The PCB/electronics shall not be freely accessible/touchable in the installed condition.
- 3259555 The electronic components shall be designed such that ESD damage cannot occur.
- 3269876 If it becomes apparent over the course of development that the supplier does not fulfill one of the following requirements, the component is electrostatically sensitive and ESD load containers/packaging will be required

2.1.13.3 Electronic System Interfaces (2124869)

2.1.13.3.1 Lamp/Vehicle Electrics Interface (Control Unit) (2124871)

- 2124870
FI_EE-5 *To ensure the function of the lamp/vehicle electrics interface and to adapt the electrical functions of the lamp to the control unit, the following measures are to be carried out by the supplier:*
- 2124872
FI_EE-7 The supplier shall coordinate the electronic interfaces of the lamp with the contact from the client's development department.
- 2124873
FI_EE-1651 Differing functions shall not interact, i.e. no feedback to other channels may occur during the internal interconnection of functions/channels.
- 2124875
FI_EE-1650 The outputs actuated by the control unit shall not have specified capacitive loads at the input of the lamps, i.e. if special input circuits are used, the capacitive loads need to be adapted to the individual component parts/drivers of the control unit.
- 2124874
FI_EE-1976 The supplier shall provide five sets of electronic samples (board assemblies) for test stands, BC suppliers, E/E vehicles, and component tests:
The lamp variants shall be coordinated with the client's Development contact.
The corresponding costs, as well as the packaging and logistics costs, are included in the supplier development costs.
- 3345436 The supplier shall provide five sets of off-tool part samples for test benches, BC suppliers, E-E vehicles, component tests:
The lamp variants shall be coordinated with the client's Development contact.
The corresponding costs, as well as the packaging and logistics costs, are included in the supplier development costs.
- 2124877
FI_EE-4143 *Definition of 1 set of taillights:
One-piece taillights: Left sidewall lamp + right sidewall lamp
Multi-part taillights: Left sidewall lamp + left trunk lid lamp/rear-end door lamp + right sidewall lamp + right trunk lid lamp/rear-end door lamp
Taillights with taillight band: Left sidewall lamp + right sidewall lamp + center taillight band*

Mercedes-Benz - Confidential -	<small>Schutzvermerk DIN ISO 16016 beachten! /Refer to protection notice DIN ISO 16016! Keine Aenderung ohne Zustimmung der federfuehrenden Konstruktion / Any alterations are subject to the approval of the design department</small>	Bearb./auth.: Hans Peter Schiffert Abt./dep.: RD/KEL Datum/date: 2022-07-25 Requirement Specifications 001 version: Seite/page: 57 of 220
	Technical Component Requirement Specifications Tail lamp QEV 111 AJPNLG	

2124876
FI_EE-3870

For the electronic samples, it is enough to just have the electronics (PCBs, component parts, wiring, original connector plugs, etc.) installed on a board (not wood) with spacers.

2963005

If failure detection is included, it shall be possible to simulate the failure using a jumper.

2963006

It shall be possible to simulate the following fault types using a jumper:

2963007

Open load of an LED strand of the light function within a lamp element.

2963008

Short circuit of an LED strand of the light function within a lamp element. This is only necessary if the LEDs tend to fail due to short circuits.

2124878
FI_EE-13

The delivery date of the electronic samples shall be coordinated with the MB contact and provided by the test vehicle deadline at the latest.

3119237

The delivery date of the configuration file/parameterization file for the electronic samples shall be coordinated with the MB contact and provided two weeks before the test vehicle deadline at the latest.

3119229

The delivery date of the off-tool part samples shall be coordinated with the MB contact and provided eight weeks before the application vehicle deadline at the latest.

3119242

The delivery date of the configuration file/parameterization file for the off-tool part samples shall be coordinated with the MB contact and provided ten weeks before the application vehicle deadline at the latest.

2.1.13.4 Component Design (2124889)

2.1.13.4.1 Circuit Specifications - Integrated Tail Lamp Control (ITC) (2813892)

2.1.13.4.1.1 General (2872112)

2872113

The ITC (Integrated Tail Lamp Control) is the interface between a lamp/lamp combination and the BC (body controller). Communication takes place via a physical CAN bus system.

2995786

In total, there are two CAN interfaces (ITC-CAN1 and ITC-CAN2) for the actuation of all rear lamp elements in the vehicle.

2872114

In addition to the bus system, this interface includes software elements, the transceivers in the BC, and the LED drivers in the lamp.

4093550

To ensure smooth animation, a maximum of 2 LED strands may be actuated at a time. If required, the only exception is the reversing light.

<p>Mercedes-Benz - Confidential -</p>	<p><small>Schutzvermerk DIN ISO 16016 beachten! /Refer to protection notice DIN ISO 16016! Keine Aenderung ohne Zustimmung der federfuehrenden Konstruktion / Any alterations are subject to the approval of the design department</small></p> <p>Technical Component Requirement Specifications Tail lamp QEV 111 AJPNLG</p>	<p>Bearb./auth.: Hans Peter Schiffert Abt./dep.: RD/KEL Datum/date: 2022-07-25 Requirement Specifications 001 version: Seite/page: 58 of 220</p>
---	--	--

2.1.13.4.1.2 Connection (2876783)

2.1.13.4.1.2.1 Central Connector (2876784)

- 2876787 The central connector shall be designed as an encapsulated component part.
- 2876788 The central connector shall be coded poka-yoke-reliably based on the lamp variants.
- 2876791 The exact design of the central connector is defined on the RFQ drawing.
- 2876789 If the central connector is not included in the RFQ drawing, it shall be coordinated with the E-E contact.
- 2876790 All connectors installed on the lamp shall be fastened in the housing with zero clearance: This is to prevent creating noise sources.
- 2876793 All connectors installed on the lamp shall be protected against accidental disconnection (strain-relief clamp). This shall withstand a pull of at least 40 N.
- 3079431 The permanent current at an MQS contact (0.63 x 0.63) shall not exceed 4.5 A.
- 3209977 The permanent current at an MLK contact (1.2 x 0.6) shall not exceed 6.5 A.

2.1.13.4.1.2.2 Pin Assignment (2876786)

- 2876794 Pin 1 must be the ground pin.
- 2876795 The supplier shall label the pin assignment at the lamp, next to the plug.
- 2876796 The exact pin assignment is defined on the RFQ drawing.
- 2876797 If the pin assignment is not included in the RFQ drawing, it shall be coordinated with the E-E contact.
- 2876798 The plug pins shall be pressed into a carrier board.
- 2876799 The CAN conductor tracks (CAN-H/CAN-L) shall run parallel to each other.
- 2876800 The CAN conductor tracks (CAN-H/CAN-L) shall be designed to be as short as possible.
- 2876901 The CAN conductor tracks (CAN-H/CAN-L) shall be designed to have the same length.
- 2878542 The requirements from [\[MSS 20202\]](#) shall be observed. Especially the Chapter "Connector Requirements and Approved Connectors".

Mercedes-Benz - Confidential -	<small>Schutzvermerk DIN ISO 16016 beachten! /Refer to protection notice DIN ISO 16016! Keine Aenderung ohne Zustimmung der federfuehrenden Konstruktion / Any alterations are subject to the approval of the design department</small>	Bearb./auth.: Hans Peter Schiffert
	Technical Component Requirement Specifications Tail lamp QEV 111 AJPNLG	Abt./dep.: RD/KEL Datum/date: 2022-07-25 Requirement Specifications version: 001 Seite/page: 59 of 220

2.1.13.4.1.3 System Description (2872115)

2.1.13.4.1.3.1 Basic Diagram (Software and Hardware Parts) (2872116)

2872117

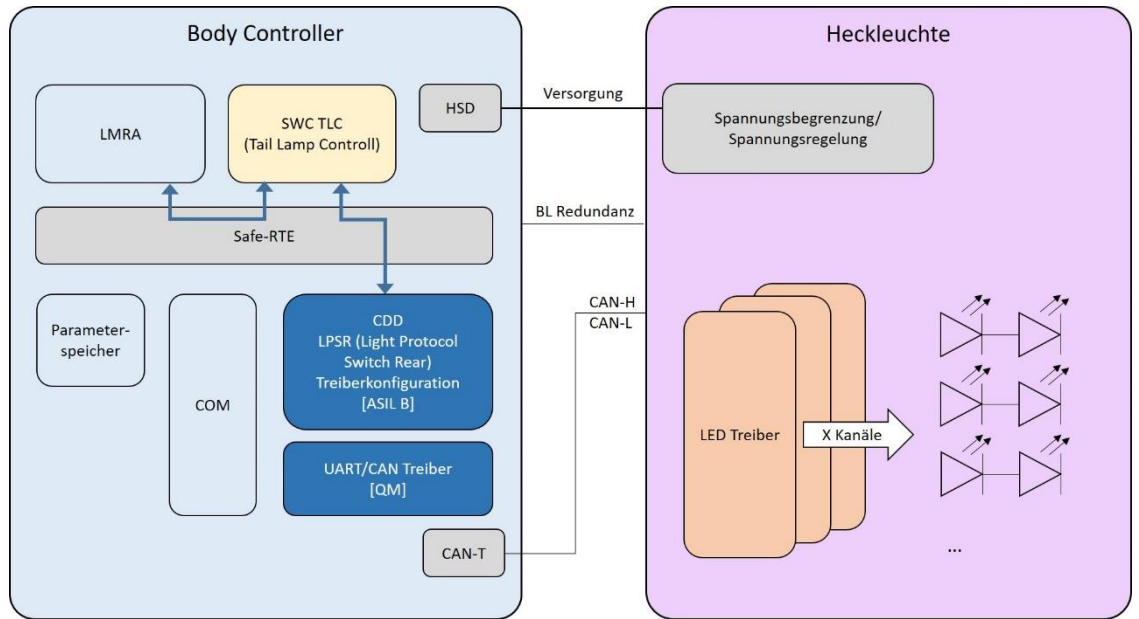

2872124

The BC receives information on how to actuate the lamp via a configuration file and a parameterization file generated in the GUI.

2872127

The actuation of the lamp by the BC is done via a physical CAN.

2872129

From a functional safety perspective, a brake light redundancy line is required to take over actuation in the event of errors.

2872132

Voltage limitation/voltage regulation is done in the lamp and helps to protect the LED drivers or reduce the power in the LED drivers.

2872134

The actuation of the LED strands is done via LED drivers. If necessary (depending on the current), an LED strand can be divided between several driver channels. However, there may only ever be one LED strand connected to a driver channel.

2872137

Several LED strands can be combined to form a pixel via the GUI. A pixel can therefore comprise several different LED strands. However, a strand may only be assigned to one pixel.

Mercedes-Benz - Confidential -	<small>Schutzvermerk DIN ISO 16016 beachten! /Refer to protection notice DIN ISO 16016! Keine Aenderung ohne Zustimmung der federfuehrenden Konstruktion / Any alterations are subject to the approval of the design department</small>	Bearb./auth.: Hans Peter Schiffert Abt./dep.: RD/KEL Datum/date: 2022-07-25 Requirement Specifications version: 001 Seite/page: 60 of 220
	Technical Component Requirement Specifications Tail lamp QEV 111 AJPNLG	

2.1.13.4.1.3.2 Wiring in the Vehicle (2872139)

2872140

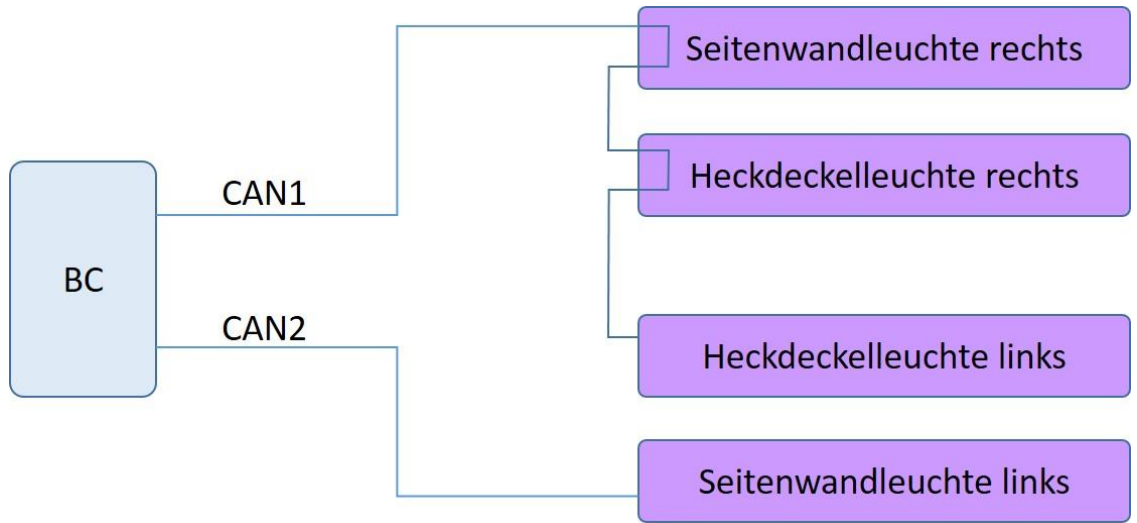

2872141

Cable splicing is not permissible in the lamp. The loop-through of the CAN line shall be done on the PCB.

2.1.13.4.1.4 Voltage Limitation/Voltage Regulation (2875300)

2905169

The electronic connection to the central connector is done via a connector module (SM) or a connector power module (SPM)

2905180

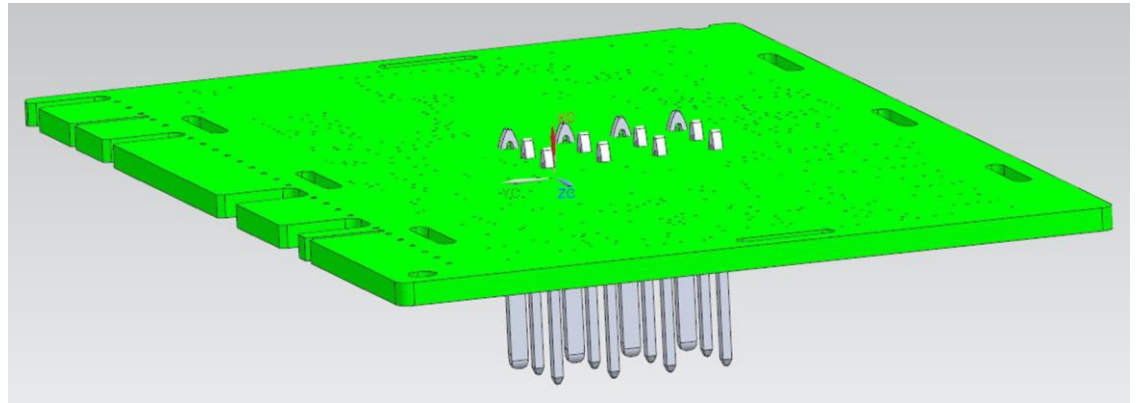

2905174

Both are PCBs with pressfit pins on the reverse that form the electrical connection to the vehicle wiring harness.

2905170

The only difference between an SM and an SPM is that the voltage limitation/voltage regulation for the SPM is located in whole or in part on the PCB, while the SM only routes the connections through.

<p>Mercedes-Benz - Confidential -</p>	<p><small>Schutzvermerk DIN ISO 16016 beachten! /Refer to protection notice DIN ISO 16016! Keine Aenderung ohne Zustimmung der federfuehrenden Konstruktion / Any alterations are subject to the approval of the design department</small></p> <p>Technical Component Requirement Specifications Tail lamp QEV 111 AJPNLG</p>	<p>Bearb./auth.: Hans Peter Schiffert Abt./dep.: RD/KEL Datum/date: 2022-07-25 Requirement Specifications 001 version: Seite/page: 61 of 220</p>
---	--	--

- 2905178 The connection to the LED PCB is established via the edge contact connectors
- 2905167 The type (electronic circuit) of voltage limitation/voltage regulation depends on the concept and is the responsibility of the supplier.
- 2876317 If a DC/DC is used, the following requirements shall be complied with as minimum requirements:
- 2900686 - The PCB shall be designed to have at least four layers.
- 2900687 - An EMC protective cover for the electronic components shall be provided and connected to ground with low impedance during use.
- 2900688 - The standard layout shall also be retained for further projects with DC/DC, to the extent that this is technically feasible.
- 2905309 - Interference emission measurement reports for the suggested layout shall be made available to MB.
- 2900690 - The power dissipation shall be less than 10%.

Example of SPM integration in a lamp

2897191

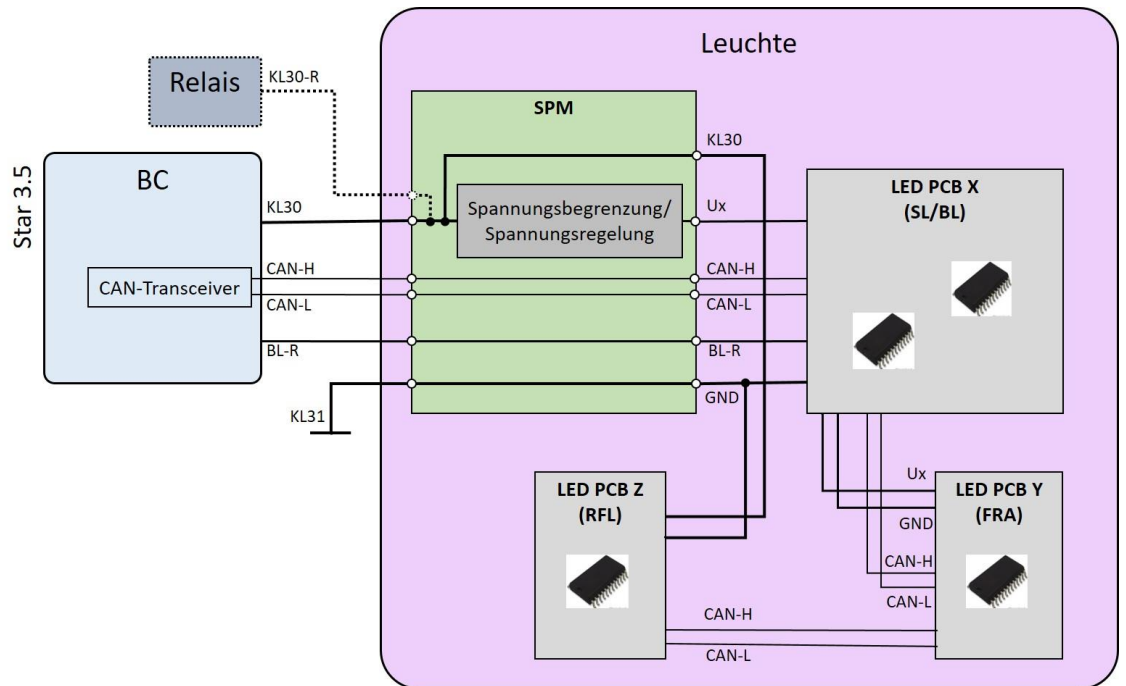

- 2897192 The power supply can be provided via the Ux voltage stabilized/regulated by the supplier or via the routed-through terminal 30.
- 2901138 The CAN lines (CAN-H/CAN-L), the BL redundancy line (BL-R), and GND are directly routed through.

Mercedes-Benz - Confidential -	<small>Schutzvermerk DIN ISO 16016 beachten! /Refer to protection notice DIN ISO 16016! Keine Aenderung ohne Zustimmung der federfuehrenden Konstruktion / Any alterations are subject to the approval of the design department</small> Technical Component Requirement Specifications Tail lamp QEV 111 AJPNLG	Bearb./auth.: Hans Peter Schiffert Abt./dep.: RD/KEL Datum/date: 2022-07-25 Requirement Specifications version: 001 Seite/page: 62 of 220

2.1.13.4.1.5 CAN (2887027)

2.1.13.4.1.5.1 CAN Wiring (2887028)

- 2887030 A termination shall be provided in the layout for every CAN LED driver in its network.
- 2887034 A decentralized termination shall be preferred, using the longest path of the respective network (termination in the master ECU (BC) and in the most remote LED driver in the respective network).
- 2887031 The determination of the termination will be made after checking the network physics and shall be coordinated with the client's Development contact.
- 2905310 Corresponding electronic components shall be provided in the layout for EMC debugging.
- 2887032 The requirements from [\[MSS 20202\]](#) shall be observed.
- 4020754 - The requirements with respect to the CAN protocol do not need to be applied.
- 4020758 - The number of CAN filters can also be reduced to a single filter for each lamp part if the supplier is able to demonstrate with the EMC vehicle test that this is sufficient.
- 5118330 - Contrary to the standard, the supplier can also position an LED driver further than 50 mm from the connector as long as it adheres to the signal integrity.
- 5118331 - Contrary to the standard, the supplier can also position an LED driver further than 50 mm from the filter as long as it adheres to the signal integrity.
- 2887035 The CAN lines (CAN-H/CAN-L) in the rear lamp shall be twisted.
- 2887036 The CAN lines (CAN-H/CAN-L) and the CAN conductor tracks (CAN-H/CAN-L) shall have the same length.
- 2887038 The CAN conductor tracks (CAN-H/CAN-L) shall be routed parallel to each other.

2.1.13.4.1.5.2 Baud Rates/Refresh Rates (2887029)

- 2887039 The determination of the baud rate of the communications interface shall be made by the supplier and the Development contact.
- 2887040 A baud rate of 500 kbit/s is assumed as the default value.
- 2887041 If technical reasons make it necessary to deviate from 500 kbit/s, this shall be coordinated with the Development contact.
- 2887044 The maximum baud rate of the master is 1 Mbit/s and can be fully utilized after coordination with MB, but never exceeded.

Mercedes-Benz - Confidential -	<small>Schutzvermerk DIN ISO 16016 beachten! /Refer to protection notice DIN ISO 16016! Keine Aenderung ohne Zustimmung der federfuehrenden Konstruktion / Any alterations are subject to the approval of the design department</small>	Bearb./auth.: Hans Peter Schiffert
	Technical Component Requirement Specifications Tail lamp QEV 111 AJPNLG	Abt./dep.: RD/KEL Datum/date: 2022-07-25 Requirement Specifications version: 001 Seite/page: 63 of 220

2.1.13.4.1.5.3 Bus Load Calculation (3236784)

- 3236787 A bus load calculation shall be prepared for the ITC (CAN1/CAN2).
- 3245679 The following conditions shall be taken as the basis for the bus load calculation:
- 3245683 - For each channel used, a new brightness value (PWM value) is transmitted for each refresh cycle.
- 3245685 - Unless agreed otherwise, the refresh rate is 10 ms.
- 3245687 - Every driver shall be diagnosed once within 100 ms.
- 3249261 - The supplier shall include additional diagnosis messages in the calculation, provided they are necessary for fulfilling the supplier's diagnosis objectives.
- 3245680 The bus load shall not exceed 80% at a refresh rate of 10 ms.
- 3245691 The bus load calculation shall be provided to the client.
- 3245692 The bus load calculation shall be submitted with the offer presentation.
- 3245697 In the event of changes to the electronics of the lamp (e.g. number of drivers or number of driver channels used), the bus load calculation shall be carried out again.
- 3245702 The results of the new bus load calculation shall be discussed with and made available to the client.

2.1.13.4.1.5.4 Signal Integrity Analysis (3236786)

- 3236788 A signal integrity analysis (simulation) of the network physics shall be prepared with the selected driver and the data provided by the client regarding the vehicle wiring harness and the CAN transceiver in the master.
- 3236790 The simulation shall include the communication from the master ECU to every LED driver and the communication from the LED drivers to the master ECU.
- 3236791 The simulation shall take the defined temperature range of the rear lamp into account.
- 3236792 The simulation shall be carried out with the baud rate determined in accordance with the bus load calculation.
- 3236793 The following data shall be presented as results:
- 3236817 - Appropriate distribution of the rear lamp elements between interfaces ITC-CAN1 and ITC-CAN2.
- 3236821 - Adjustment/determination of the sampling points.
- 3236858 - The network margin/safety margin for the selected settings and terminations, for the transmission of the nodes and of the master respectively.
- 3236859 - The longest delay for the respective transmitter shall be sufficiently smaller than the

Mercedes-Benz - Confidential -	<small>Schutzvermerk DIN ISO 16016 beachten! /Refer to protection notice DIN ISO 16016! Keine Aenderung ohne Zustimmung der federfuehrenden Konstruktion / Any alterations are subject to the approval of the design department</small>	Bearb./auth.: Hans Peter Schiffert
	Technical Component Requirement Specifications Tail lamp QEV 111 AJPNLG	Abt./dep.: RD/KEL Datum/date: 2022-07-25 Requirement Specifications version: 001 Seite/page: 64 of 220

network margin for this transmitter.

- 3236860 - Data settle time including ringing and signal symmetry between the nodes
- 3236794 The simulation shall be carried out with various termination options.
- 3236861 The determination of the termination is made jointly by the contractor and the client.
- 3236862 The simulation results shall be provided to the client.
- 3236863 The results of the simulation shall be submitted with the offer presentation.
- 3236864 In the event of changes to the electronics of the lamp (PCB, driver, internal wiring), the simulation shall be carried out again
- 3236865 The results of the new simulation shall be discussed with and made available to the client.

2.1.13.4.1.6 LED Drivers (2888236)

- 2888237 MB recommends using one of the four following LED drivers:
- 2995788 - Elmos 522.94
- 2995789 - Elmos 522.95
- 2995790 - Infineon TLD7002
- 2995791 - STM L99LDLL16 (with the expansion for external CAN communication (6 kV ESD protection))
- 3069435 The selected driver shall comply with the requirements of [\[ISO 11898-2\]](#).
- 2896343 The client (translator's note: contractor?) shall ensure that the LED driver it has selected complies with all the requirements.
- 2896344 The client (translator's note: contractor?) can suggest additional LED drivers, provided that they meet all the requirements.
- 2896345 The contractor shall present the results of the test as to whether the selected driver is suitable for this application during the technical presentation as part of the contract award process.
- 2896346 The contractor shall make available corresponding data sheets/documents of the selected driver.

Mercedes-Benz - Confidential -	<small>Schutzvermerk DIN ISO 16016 beachten! /Refer to protection notice DIN ISO 16016! Keine Aenderung ohne Zustimmung der federfuehrenden Konstruktion / Any alterations are subject to the approval of the design department</small>	Bearb./auth.: Hans Peter Schiffert
	Technical Component Requirement Specifications Tail lamp QEV 111 AJPNLG	Abt./dep.: RD/KEL Datum/date: 2022-07-25 Requirement Specifications version: 001 Seite/page: 65 of 220

2.1.13.4.1.7 LED-PCB Circuit (2896347)

2896348 Example of wiring diagram

2896349

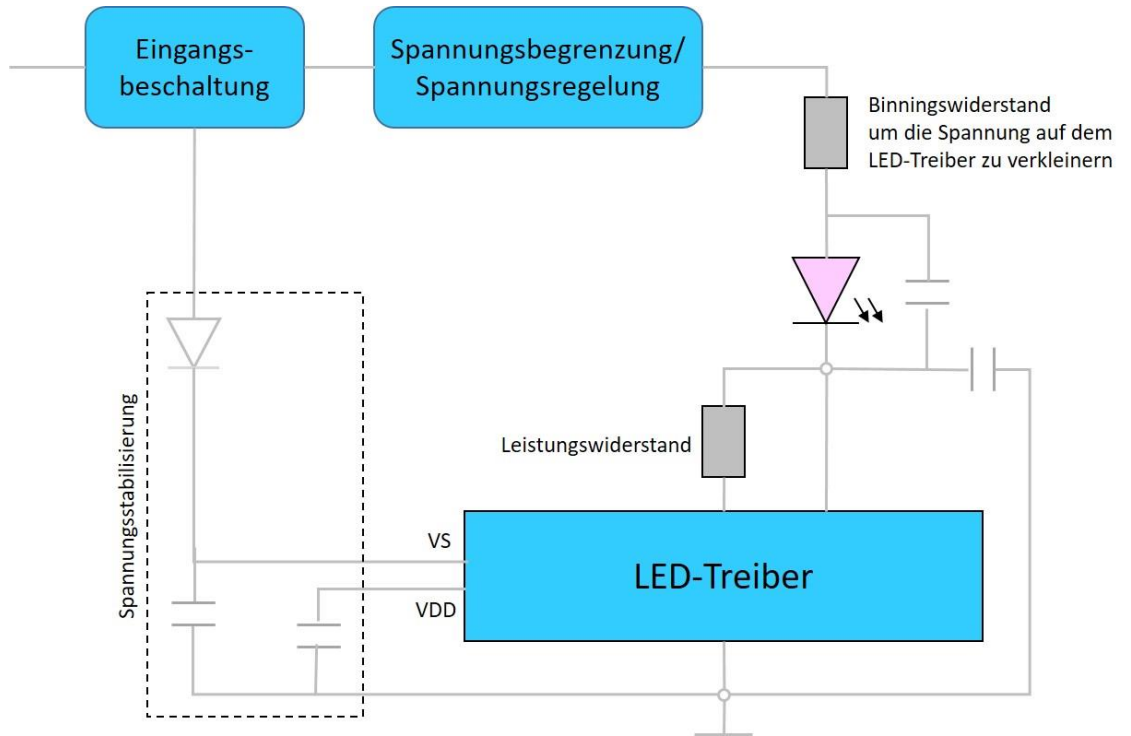

2945148 The current is adjusted (e.g. bin adjustment/thermal adjustment) in the lamp.

2896910 The variance of current adjustment between the LED driver channels of different drivers shall not exceed +/- 5%.

2905313 In the event of a thermally critical application, measures shall be taken in the circuit for thermal relief of the LED driver.

2905314 Electronic components for voltage stabilization shall be provided.

2.1.13.4.1.8 BL Redundancy Line (3010442)

3010443 Basic diagram

<p>Mercedes-Benz - Confidential -</p>	<p style="font-size: small;">Schutzvermerk DIN ISO 16016 beachten! /Refer to protection notice DIN ISO 16016! Keine Aenderung ohne Zustimmung der federfuehrenden Konstruktion / Any alterations are subject to the approval of the design department</p> <p style="text-align: center;">Technical Component Requirement Specifications Tail lamp QEV 111 AJPNLG</p>	<p>Bearb./auth.: Hans Peter Schiffert Abt./dep.: RD/KEL Datum/date: 2022-07-25 Requirement Specifications version: 001 Seite/page: 66 of 220</p>
---	---	---

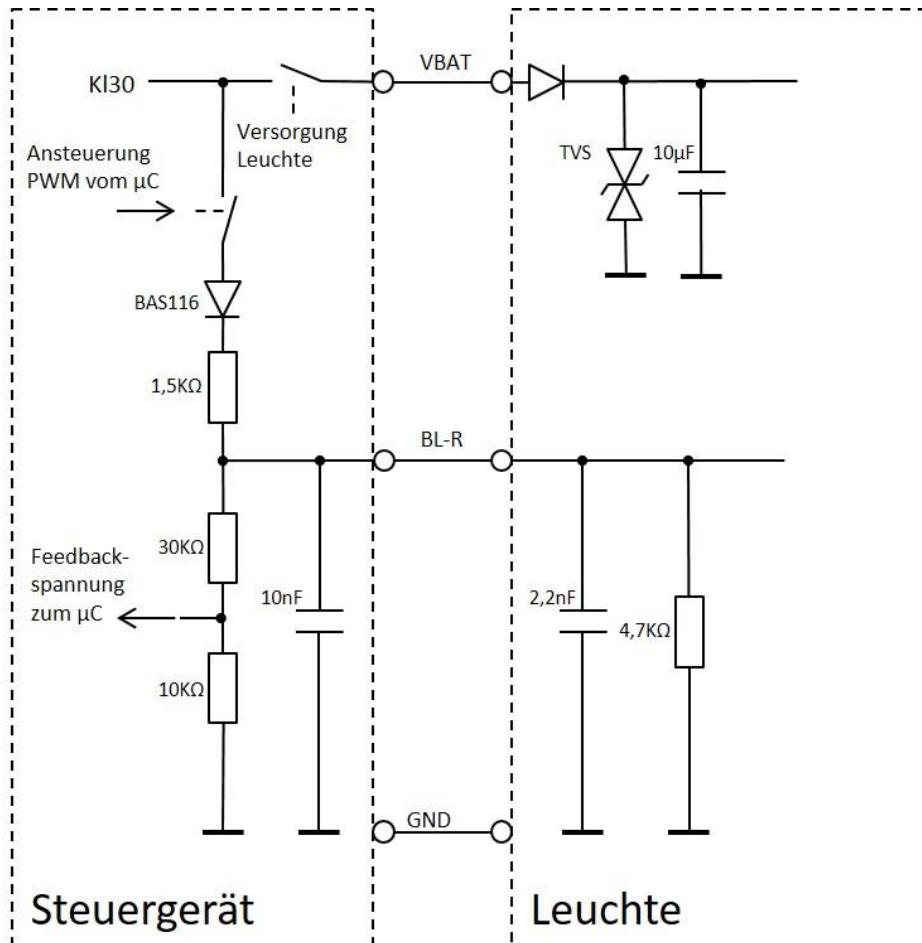

3010547

The BL-R function is designed to be active high. This means that, in the event of a brake light request, the voltage level is "high". If there is no brake light request, the switch in the BC is open and the voltage level is "low".

3069475

The input circuit of the BL-R line shall be coordinated with the MB contact.

2.1.13.4.1.9 Behavior over Time (2896912)

2896914

The timeline of every light function from the activation signal to the switching on of the LEDs shall be disclosed.

2995896

The light function shall be switched on within 20 ms of the corresponding message being present on the bus.

2896920

All tolerances and worst-case values shall be added to the timeline.

2896921

At a cycle frequency of 300 Hz, the LED drivers shall create the corresponding PWM at the LED output within 7 ms after receipt of the activation message.

2896922

In the event of simultaneous activation of a function/dynamic light sequence of different lamp elements (sidewall lamp, trunk lid lamp, continuous reflector strip), the difference shall be < 10 ms.

Mercedes-Benz - Confidential -	<small>Schutzvermerk DIN ISO 16016 beachten! / Refer to protection notice DIN ISO 16016! Keine Änderung ohne Zustimmung der federführenden Konstruktion / Any alterations are subject to the approval of the design department</small>	Bearb./auth.: Hans Peter Schiffert Abt./dep.: RD/KEL Datum/date: 2022-07-25
	Technical Component Requirement Specifications Tail lamp QEV 111 AJPNLG	Requirement Specifications 001 version: Seite/page: 67 of 220

2904782 During the dynamic light sequence phase, in the event of simultaneous activation of the scenario, this shall run synchronously in the different lamp elements (sidewall lamp, trunk lid lamp, continuous reflector strip). The variance shall be max. 5 ms.

2.1.13.4.1.10 Diagnosis (2904807)

2925290 It shall be possible to read out the firmware status of the LED driver using a diagnostic command.

3073923 At least 1 byte shall be reserved in the memory of the LED drivers for this purpose.

2925297 During the selection of the LEDs and the LED drivers, it shall be ensured that typical LED failures match the diagnosis capabilities of the LED driver.

2925298 For instance, if LEDs are used that have a high probability of failing due to a short circuit, the driver shall also be capable of detecting the short circuit.

2925299 An open load and short circuit (to the positive terminal or to ground) of the LEDs shall be detected by the LED driver after 10 ms at the latest. In this context, partial failures (e.g. 2 LEDs in a strand) shall also be detected.

2925300 Note: Corresponding debouncing is carried out in the BC.

2925301 The status (ON/OFF) of the BL redundancy line (hardware line) shall be communicated to the BC via the bus.

2925302 Internal errors of the LED driver shall be sent to the BC. These include a faulty channel status or an interruption of communication.

2945150 The error behavior and the type of fault report to the BC shall be coordinated with MB.

2925303 Relevant error statuses of the DC/DC (if available) shall be detected and sent to the BC.

2925304 Deviations in the power supply shall be detected. This can be done using output current monitoring, for instance.

2925305 Note: In the event of an error in the power supply of the LED driver, the BC detects a timeout in the communication.

2925306 All error statuses shall be sent to the BC via the bus.

2925307 For each channel, at least the following information shall be sent to the BC:

2925309 - Channel ON

2925310 - Channel OFF

2925311 - Channel error

2925308 For communication monitoring, see Chapter Functional Safety Requirements.

2925312 A temperature derating of the light functions is not permissible.

2974523 If it is necessary from a thermal perspective to adjust the RFL to a lower value after a

<p>Mercedes-Benz - Confidential -</p>	<p style="font-size: small;">Schutzvermerk DIN ISO 16016 beachten! /Refer to protection notice DIN ISO 16016! Keine Aenderung ohne Zustimmung der federfuehrenden Konstruktion / Any alterations are subject to the approval of the design department</p> <p style="text-align: center;">Technical Component Requirement Specifications Tail lamp QEV 111 AJPNLG</p>	<p>Bearb./auth.: Hans Peter Schiffert Abt./dep.: RD/KEL Datum/date: 2022-07-25 Requirement Specifications 001 version: Seite/page: 68 of 220</p>
---	---	--

certain period of time, this can be done via the BC.

- 3236594 To this end, all the legally required light values shall be complied with for this lower value.
- 3236604 Furthermore, this shall be coordinated with the MB contact beforehand
- 2975188 If it is necessary to completely deactivate the function due to an excessively high LED driver temperature (fire hazard), an error shall be communicated to the BC.
- 2925313 For all error cases, the required diagnosis quality of Functional Safety shall be observed.
- 2925314 Limitations in error detection shall be communicated to the client.

2.1.13.4.1.11 GUI (Graphical User Interface) (2925315)

- 2925316 The maximum number of pixels that can be modified with regard to brightness is 100 per vehicle side.
- 2945154 These pixels can randomly be assigned to the tail light, brake light, turn indicator, and rear fog light functions.
- 2945169 A pixel can include several light functions (e.g. combined tail light/brake light)
- 2945165 Another three pixels are reserved for the reversing light.
- 2945174 The maximum number of LED drivers per vehicle is 30.
- 2945176 This leads to a maximum of 480 hardware channels (for 16-channel LED drivers).
- 2945182 If more hardware channels or pixels are required for technical reasons, this shall be discussed with MB.

2.1.13.4.1.12 EMC (2945188)

2.1.13.4.1.12.1 Interference Emissions (2950979)

- 2950980 The supplier shall disclose its EMC concept at the time of contract award.
- 2950982 All frequencies of the system shall be presented. For instance, the PWM frequency, the DC/DC frequency, etc.
- 2950984 The maximum cycle frequency of the DC/DC shall not exceed 500 kHz. If technical reasons make it necessary to exceed 500 kHz, this shall be coordinated with the MB contact.
- 2950985 The edge steepness shall be disclosed and coordinated with MB.
- 2950987 If electronic components are used that cause interference emissions, the EMC protective cover provided shall be installed.
- 2950988 If line-borne disturbances are to be expected, placeholders shall be reserved in the

Mercedes-Benz - Confidential -	<small>Schutzvermerk DIN ISO 16016 beachten! / Refer to protection notice DIN ISO 16016! Keine Aenderung ohne Zustimmung der federfuehrenden Konstruktion / Any alterations are subject to the approval of the design department</small>	Bearb./auth.: Hans Peter Schiffert
	Technical Component Requirement Specifications Tail lamp QEV 111 AJPNLG	Abt./dep.: RD/KEL Datum/date: 2022-07-25 Requirement Specifications version: 001 Seite/page: 69 of 220

layout for ferrites and capacitances.

2951491 In the event of an unsuccessful EMC vehicle measurement, it shall be possible to correct this without layout adjustment.

2951492 It shall be possible to suppress interference on the CAN lines by means of appropriate measures.

2.1.13.4.1.12.2 Immunity (2951496)

2951641 As a general rule, it is not permissible for the lamp to switch off autonomously. If this is necessary from a functional safety perspective, the number of reactivation attempts shall be programmable.

2951501 If technical reasons (e.g. interference creates a fault entry) make it necessary to switch the lamp off briefly, it shall subsequently switch back on autonomously (with no outside help).

2.1.13.4.1.13 Supplementary functional safety requirements for the ELC (exterior light control) (2951644)

2951645 *Note: The lamp elements are powered by a terminal 30 (KL30L) controlled by a master control unit (BC).*

2965035 *Note: All light functions of the lamp are actuated via the communications interface.*

2965036 The supplier shall comply with the functional safety requirements without the BC transmitting intentional error messages with which the driver can check its error mechanism.

2965048 The supplier shall comply with the functional safety requirements without an active reset of the BC.

2965411 A mechanism shall be implemented that, in the event of active power supply of the lamp and defective/erroneous communication, activates the tail light (emergency light) after a timeout period.

2965420 In the event of defective/erroneous communication of the brake light, the brake light redundancy line (hardware line) takes over actuation.

2965422 This brake light emergency light does not need to match the original brake light pattern 1:1 (e.g. for a BL element on the trunk lid); however, the legal requirements shall be complied with.

2965439 As soon as communication with the BC is OK again, the original brake light pattern shall once again be actuated via the communications interface.

2965423 The brake light emergency light shall be coordinated with the MB contact.

Mercedes-Benz - Confidential -	<small>Schutzvermerk DIN ISO 16016 beachten! / Refer to protection notice DIN ISO 16016! Keine Änderung ohne Zustimmung der federführenden Konstruktion / Any alterations are subject to the approval of the design department</small>	Bearb./auth.: Hans Peter Schiffert
	Technical Component Requirement Specifications Tail lamp QEV 111 AJPNLG	Abt./dep.: RD/KEL Datum/date: 2022-07-25 Requirement Specifications version: 001 Seite/page: 70 of 220

2.1.13.4.1.14 Cooperation Model (2962184)

2962187

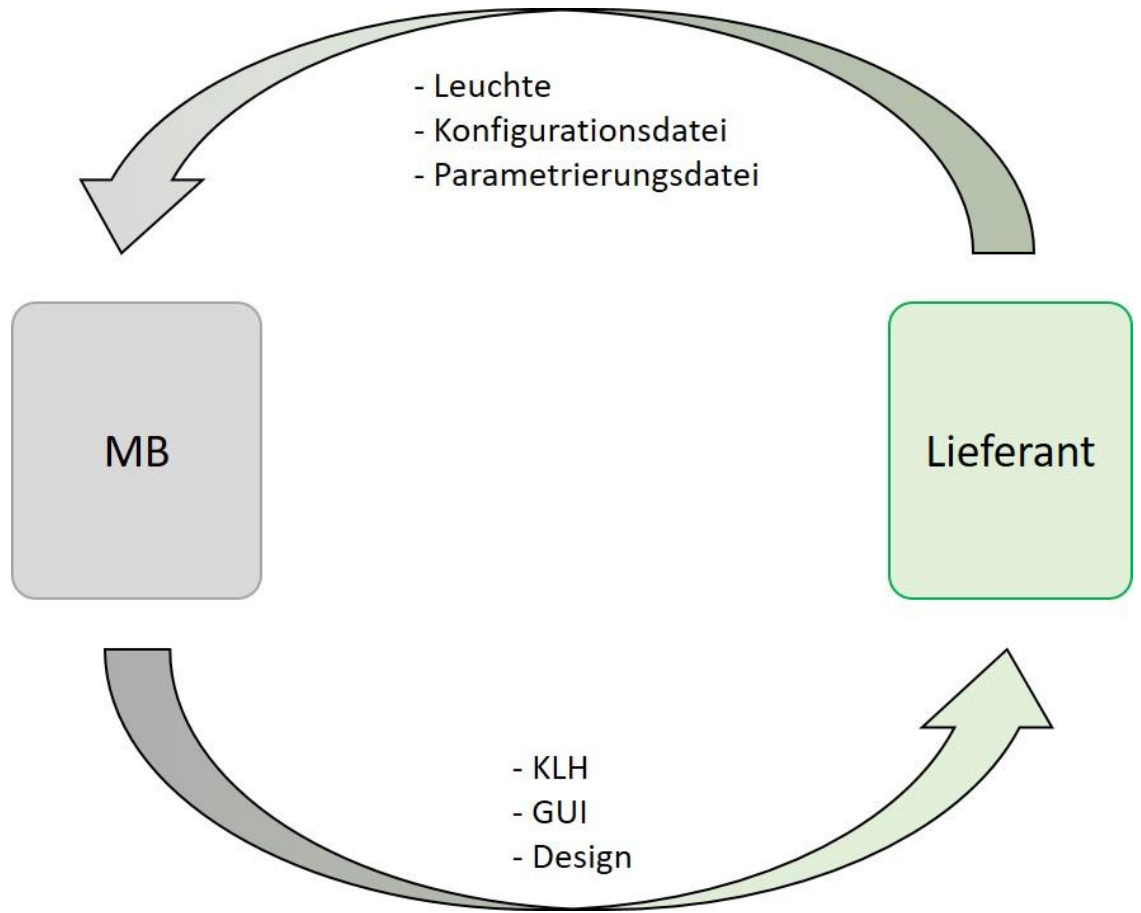

2.1.13.4.1.15 Actuation and Diagnosis (2964951)

2964952

Actuation boxes

2964970

The supplier shall provide a means of actuation, configuration, and troubleshooting.

2964966

Break-out boxes

2964972

The supplier provides three sets of break-out boxes to interrupt the vehicle wiring harness. A break-out box comprises a light element.

2995770

Definition of 1 set of break-out boxes:

One-piece taillight: Left sidewall lamp + right sidewall lamp

Multi-part taillights: Left sidewall lamp + left trunk lid lamp/rear-end door lamp + right sidewall lamp + right trunk lid lamp/rear-end door lamp

Taillights with taillight band: Left sidewall lamp + right sidewall lamp + center taillight band

2964976

Illustration example of break-out box

Mercedes-Benz - Confidential -	<small>Schutzvermerk DIN ISO 16016 beachten! / Refer to protection notice DIN ISO 16016! Keine Änderung ohne Zustimmung der federführenden Konstruktion / Any alterations are subject to the approval of the design department</small>	Bearb./auth.: Hans Peter Schiffert Abt./dep.: RD/KEL Datum/date: 2022-07-25 Requirement Specifications version: 001 Seite/page: 71 of 220
	Technical Component Requirement Specifications Tail lamp QEV 111 AJPNLG	

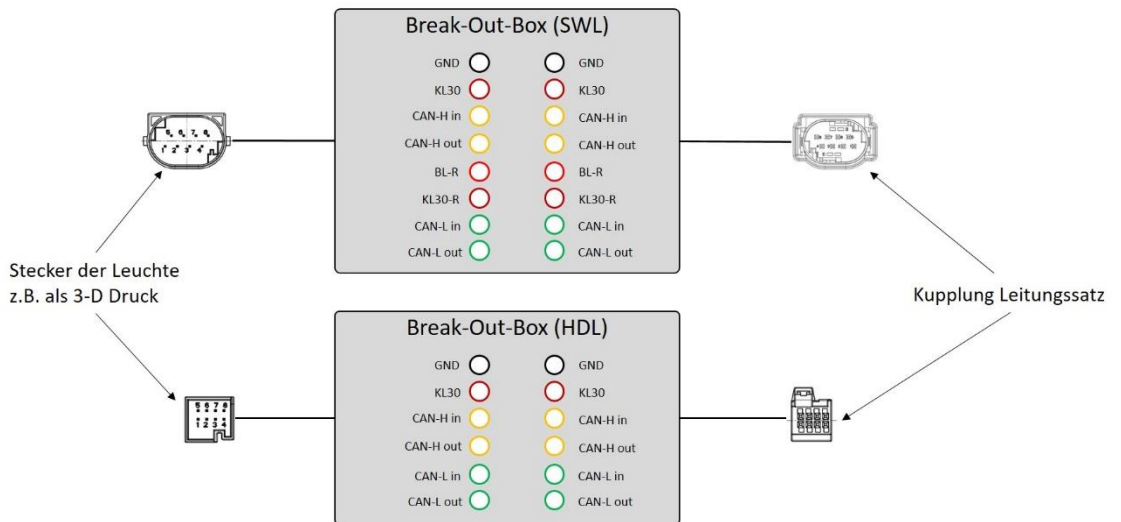

2995771

The corresponding connection can be found in the E-E slides

2.1.14

Requirements Derived from Illumination Engineering (2141313)

2141312
FI_LT-608

This module contains all information on the photometric component requirements.

2.1.14.1

General (2141311)

2141310
FI_LT-609

The values defined below apply to the legally required minimum values, not to any permitted deviations in production (e.g. COP values).

2141314
FI_LT-610

All photometric values of the lamp shall be at least 10% above the legal minimum values for the individual points or groups.

2141315
FI_LT-611

All photometric values of the lamp shall be at least 10% below the legal maximum values for the individual points or groups.

2141318
FI_LT-612

Exceeding the Mercedes maximum value is permitted only in the case of two-piece light functions (via sidewall and trunk lid lamps) after consultation with the Mercedes-Benz AG contact.

2.1.14.2

Deadlines and Project Procedure (2141323)

2141325
FI_LT-620

A work status for all actuation values (PWM/effective voltage) of the individual signaling lights' functions and of combined functions (e.g. tail lamp/brake light) shall be provided for the parts provision of the confirmation vehicle.

2141329
FI_LT-622

The final status for all actuation values (PWM / effective voltage) of the individual signaling lights' functions and of combined functions (e.g. tail lamp/brake light) shall be provided to the client before submission of the homologation.

Mercedes-Benz - Confidential -	Schutzvermerk DIN ISO 16016 beachten! / Refer to protection notice DIN ISO 16016! Keine Aenderung ohne Zustimmung der federfuehrenden Konstruktion / Any alterations are subject to the approval of the design department	Bearb./auth.: Hans Peter Schiffert Abt./dep.: RD/KEL Datum/date: 2022-07-25 Requirement Specifications 001 version: Seite/page: 72 of 220
	Technical Component Requirement Specifications Tail lamp QEV 111 AJPNLG	

- 3737180 For the taillamps, brake lights and turn indicators, the legally applicable PWM range with photometric measurements for the smallest and largest PWM values shall be taken into account in the homologation.
- 2141326
FI_LT-623 All technical light requirements shall be verified using simulations and light samples (photometric measurement results). All further requirements, such as homogeneity, shall be agreed on and confirmed with Mercedes-Benz AG by means of samples.
- 2141328
FI_LT-624 The approval document shall be maintained in the EE coordination document and the type of approval shall be communicated to Mercedes-Benz AG.

2.1.14.2.1 Physical Lamp Sample (2141331)

- 2987210 *The following requirements only apply if a physical lamp sample has been requested by Mercedes-Benz AG.*
- 2141334
FI_LT-627 Requirements pertaining to a lamp sample:
- 1) It shall be possible to individually actuate all functions and areas separately from each other (coordination with Mercedes Benz AG – also applies to sidewall lamp, trunk lid lamp, taillight band).
 - 2) Photometric measurement reports for all functions shall be available for handover.
 - 3) Luminance images for all functions shall be available for handover (simulation and warm samples with the same scaling per function)
 - 4) A label with the following information shall be affixed on the lamp sample:
 - (A) Model series (B) Handover date (C) HV values in cd per function (D) Installation height (mm) – lens (lowest point) above the roadway (E) Tail lamp actuation module information: (I) Hardware version (II) Software version (III) GUI file name (IV) Taillight actuation module actuation parameters (..)
 If a taillight actuation module is not used, the following information shall be indicated for (E) instead: PWM values (%@12.8 V) per function
 - 5) If a taillight actuation module is used, it shall be possible to connect the lamp sample with the vehicle plug. If a tail lamp actuation module is not used, it shall be possible to connect the lamp sample via cables with legibly numbered banana plugs.

2.1.14.3 Simulations and Measurements (2141330)

- 2141332
FI_LT-630 *The following requirements apply for all measurements and simulations.*
- 2141333
FI_LT-631 The measuring distance between the test part/light function and luminance camera (sensor) shall be 3,083 mm.
- 2141339
FI_LT-632 The test part/light function shall be measured in the vehicle installation position. For this purpose, it shall be aligned by means of a suitable measuring frame, for example, on the photogoniometer.
- 2141335
FI_LT-633 A lens with the focal lengths $f = 8$ mm, $f = 25$ mm, $f = 50$ mm, or $f = 100$ mm shall be selected depending on the object size.
- 2141338
FI_LT-634 Where gray filters are used, a filter with the optical density 1, 2, or 3 shall be selected.

Mercedes-Benz - Confidential -	Schutzvermerk DIN ISO 16016 beachten! /Refer to protection notice DIN ISO 16016! Keine Aenderung ohne Zustimmung der federfuehrenden Konstruktion / Any alterations are subject to the approval of the design department	Bearb./auth.: Hans Peter Schiffert Abt./dep.: RD/KEL Datum/date: 2022-07-25 Requirement Specifications 001 version: Seite/page: 73 of 220
	Technical Component Requirement Specifications Tail lamp QEV 111 AJPNLG	

- 2141337
FI_LT-636 Measurements for all light functions shall be submitted for every hardware sample.

- 2141316
FI_LT-613 Each light function shall be measured with the test voltage and/or PWM timing defined in the EE coordination document.

- 2141317
FI_LT-614 The alignment points for the measurement of every light function shall be indicated by white markings on the cover lens. All lamp samples and ISIR lamp samples shall have this marking.

- 2141343
FI_LT-638 Results and evaluations shall be handed over to the client as a technical document and in camera file format.

- 2141341
FI_LT-639 *The measuring/simulation results are used for the objective and reproducible evaluation and documentation of the light functions.
In particular, the luminance gradient course, the homogeneity, spots and diffused light, light leakage, color and color variation, dazzling, and the overall appearance are assessed and documented, as well as other factors.*

2.1.14.4 Appearance Requirements (2141348)

- 2141345
FI_LT-640 *The following requirements relate to all tail lamp functions.*

- 2141347
FI_LT-643 The lamps shall not emit any diffused light. If diffused light is used in a targeted manner to make use of photometric values of a light function, this light shall be specifically disclosed.

- 2141346
FI_LT-644 The edges of the illuminated surfaces of the lamp shall be illuminated precisely and correctly.

- 2141349
FI_LT-645 No white light must be visible in the red fields of the lamp. A clear compartment separation shall exist.

- 2141351
FI_LT-646 No colored light shall be visible in the white fields of the lamp. A clear compartment separation shall exist.

- 2141353
FI_LT-647 No light leakage shall be visible through the joints/gaps between the lamp and the body.

- 2141352
FI_LT-664 To minimize distortions in the light pattern due to an aerodynamics edge or similar structures, the lens contour in this area shall be parallel on the inside and outside and be designed in the same thickness. In addition, the inner radius shall be designed similar to the outer radius.

2.1.14.4.1 Color Selection (2141350)

- 2141354
FI_LT-648 Only one color bin may be used within a light function of a lamp. In this regard, the tail light area and the brake light area are considered separately.

Mercedes-Benz - Confidential -	<small>Schutzvermerk DIN ISO 16016 beachten! /Refer to protection notice DIN ISO 16016! Keine Aenderung ohne Zustimmung der federfuehrenden Konstruktion / Any alterations are subject to the approval of the design department</small> Technical Component Requirement Specifications Tail lamp QEV 111 AJPNLG	Bearb./auth.: Hans Peter Schiffert Abt./dep.: RD/KEL Datum/date: 2022-07-25 Requirement Specifications 001 version: Seite/page: 74 of 220
---	---	--

2.1.14.4.2 Homogeneity (2141356)

2141358
FI_LT-649 *Homogeneity means that no spots and/or light/dark shadows are visible in the signal representation. This also means a uniform luminance level between the top and bottom, and left and right.*

2141355
FI_LT-650 The illumination of all light functions shall be homogeneous.

2141357
FI_LT-651 The illumination of all individual reflectors shall be homogeneous.

2141359
FI_LT-652 Only LEDs of the same brightness class may be used within a light function for a lamp. If a light function stretches across several PCBs, different brightness classes can be used. The brightness of the individual elements of the light function shall be adjusted so that a max. luminance difference of 30% exists in the light function of the lamp pair.

2141360
FI_LT-653 In general, it shall not be possible to see a visual difference in the brightness of the left- and right-hand lamps (e.g. via adjustment of the different brightness classes using series resistors).

2141362
FI_LT-654 Within a lamp pair, the brightness classes shall be coordinated so that a visual luminance difference is not discernible.

2141364
FI_LT-655 The optical systems of every light function shall be optimized with regard to the homogeneity under all viewing angles.

5432808 The following requirements in this chapter apply to all viewing angles within the groove in the coordinate system with the following corner points:
P1 (45° outside / 0° vertical), P2 (0° horizontal / 25° top), P3 (0° horizontal / 5° bottom), P4 (45° inside / 0° vertical)

5432809 For the taillight, a luminance gradient between two arbitrary points with a distance of 10 mm from a luminous surface less than or equal to 1:2 shall be complied with. In addition, a gradient of a maximum of 1:3 shall be complied with for front surfaces (overall surface considered), and a maximum of 1:6 shall be complied with for side surfaces.

5432810 For all other functions, a luminance gradient in an illuminating surface of less than or equal to 1:6 shall be adhered to.

5432811 A max. luminance difference of the individual luminous surfaces of 30% applies where several luminous surfaces are involved in the light function (also in the case of multipiece lamps).

2.1.14.5 Function-Specific Requirements (2141376)

2.1.14.5.1 Tail Light Requirements (2141378)

2141377
FI_LT-667 *The requirements described in this chapter also apply for the side marker lamp if this*

Mercedes-Benz - Confidential -	<small>Schutzvermerk DIN ISO 16016 beachten! / Refer to protection notice DIN ISO 16016! Keine Aenderung ohne Zustimmung der federfuehrenden Konstruktion / Any alterations are subject to the approval of the design department</small>	Bearb./auth.: Hans Peter Schiffert Abt./dep.: RD/KEL Datum/date: 2022-07-25 Requirement Specifications 001 version: Seite/page: 75 of 220
	Technical Component Requirement Specifications Tail lamp QEV 111 AJPNLG	

is implemented as a separate function.

2141375
FI_LT-668

The dominant wavelength (color) of the LEDs shall be at least 635 nm (model).

2141379
FI_LT-669

The final waveband used shall be agreed on with Mercedes-Benz AG.

2.1.14.5.1.1

Standing Light Requirements (2141382)

2141381
FI_LT-671

In the event of two-part lamps (sidewall + trunk lid), the parking lamp shall only be approved with the sidewall.

2.1.14.5.2

Brake Light Requirements (5095146)

2141366
FI_LT-665

For the variants certified in accordance with the ECE standard or GB standards (vehicle and/or lamp is produced locally in China), a multi-level function shall be implemented for the brake light.

2141361
FI_LT-656

The multi-level function shall contain two levels that are set by the control unit. The high level is used in day mode (light sensor = light OFF). The low level is used in night mode (light sensor = light ON).

2141365
FI_LT-658

The light values indicated in this chapter relate to the sidewall.

2141368
FI_LT-659

The following photometric values shall be implemented in HV:
Low level: 75 cd +/-10%
High level: 121 cd to 180 cd

2141370
FI_LT-693

For country variants in which multi-level function will not be implemented, the photometric values of the indicated high levels shall be implemented.

2141372
FI_LT-662

To better adapt the lamps to the ambient conditions, the light intensity conditions between the HV values and the angle values need to be harmonized. For this purpose, the ratio between the HV values and the angle values is determined.

2141374
FI_LT-663

The following harmonization requirements shall be complied with:

Mercedes-Benz - Confidential -	<small>Schutzvermerk DIN ISO 16016 beachten! /Refer to protection notice DIN ISO 16016! Keine Aenderung ohne Zustimmung der federfuehrenden Konstruktion / Any alterations are subject to the approval of the design department</small>	Bearb./auth.: Hans Peter Schiffert
	Technical Component Requirement Specifications Tail lamp QEV 111 AJPNLG	Abt./dep.: RD/KEL Datum/date: 2022-07-25 Requirement Specifications version: 001 Seite/page: 76 of 220

Prozentuale Mindestvorgabe bezogen auf den HV-Wert								
	20L	10L	5L	V	5R	10R	20R	
15U								%
10U			20		20			%
5U	10	20		70		20	10	%
H		35	90	100	90	35		%
5D	10	20		70		20	10	%
10D			20		20			%
15D								%

5095152
FI_LT-673

The brake light shall be designed in such a way that an error message is sent to the body controller if an LED string fails and the entire remaining function is not switched off.

2.1.14.5.3 Turn Indicator Requirements (2141380)

5095216
FI_LT-658

The light values indicated in this chapter relate to the sidewall.

5095217
FI_LT-659

For yellow turn signal indicators, the following photometric values shall be implemented in HV: 75 cd - 90 cd

5095154

For variants that are certified according to FMVSS, the turn signal indicator shall fulfill the requirements for "red lamps".

5098788

For red turn signal indicators, the following photometric values shall be implemented in HV: 121 cd - 180 cd.

5095218
FI_LT-662

To better adapt the lamps to the ambient conditions, the light intensity conditions between the HV values and the angle values need to be harmonized. For this purpose, the ratio between the HV values and the angle values is determined.

5095219
FI_LT-663

The following harmonization requirements shall be complied with:

Mercedes-Benz - Confidential -	<small>Schutzvermerk DIN ISO 16016 beachten! / Refer to protection notice DIN ISO 16016! Keine Aenderung ohne Zustimmung der federfuehrenden Konstruktion / Any alterations are subject to the approval of the design department</small>	Bearb./auth.: Hans Peter Schiffert Abt./dep.: RD/KEL Datum/date: 2022-07-25 Requirement Specifications version: 001 Seite/page: 77 of 220
	Technical Component Requirement Specifications Tail lamp QEV 111 AJPNLG	

Prozentuale Mindestvorgabe bezogen auf den HV-Wert								
	20L	10L	5L	V	5R	10R	20R	
15U								%
10U			20		20			%
5U	10	20		70		20	10	%
H		35	90	100	90	35		%
5D	10	20		70		20	10	%
10D			20		20			%
15D								%

2141389
FI_LT-674

Yellow turn indicators shall be designed so that an error message is sent to the body controller if an LED string fails.

2141383
FI_LT-673

Red turn indicators shall be designed in such a way that an error message is sent to the body controller if an LED string fails and the entire remaining function is not switched off.

2.1.14.5.4 Back-up Light Requirements (2141386)

2.1.14.5.4.1 Color Selection (2141385)

2141387
FI_LT-675

The color coordinates of the back-up light shall lie in the Mercedes-Benz target range described below. If the function is to be achieved with a filter combination, the color coordinates in HV shall be within the Mercedes-Benz target range. The color coordinates of all angle areas shall be within the "ECE white" range.

Mercedes-Benz - Confidential -	<small>Schutzvermerk DIN ISO 16016 beachten! /Refer to protection notice DIN ISO 16016! Keine Aenderung ohne Zustimmung der federfuehrenden Konstruktion / Any alterations are subject to the approval of the design department</small>	Bearb./auth.: Hans Peter Schiffert Abt./dep.: RD/KEL Datum/date: 2022-07-25 Requirement Specifications version: 001 Seite/page: 78 of 220
	Technical Component Requirement Specifications Tail lamp QEV 111 AJPNLG	

Farbkoordinaten nach CIExy 1931 - Zielbereich Mercedes Benz 2014

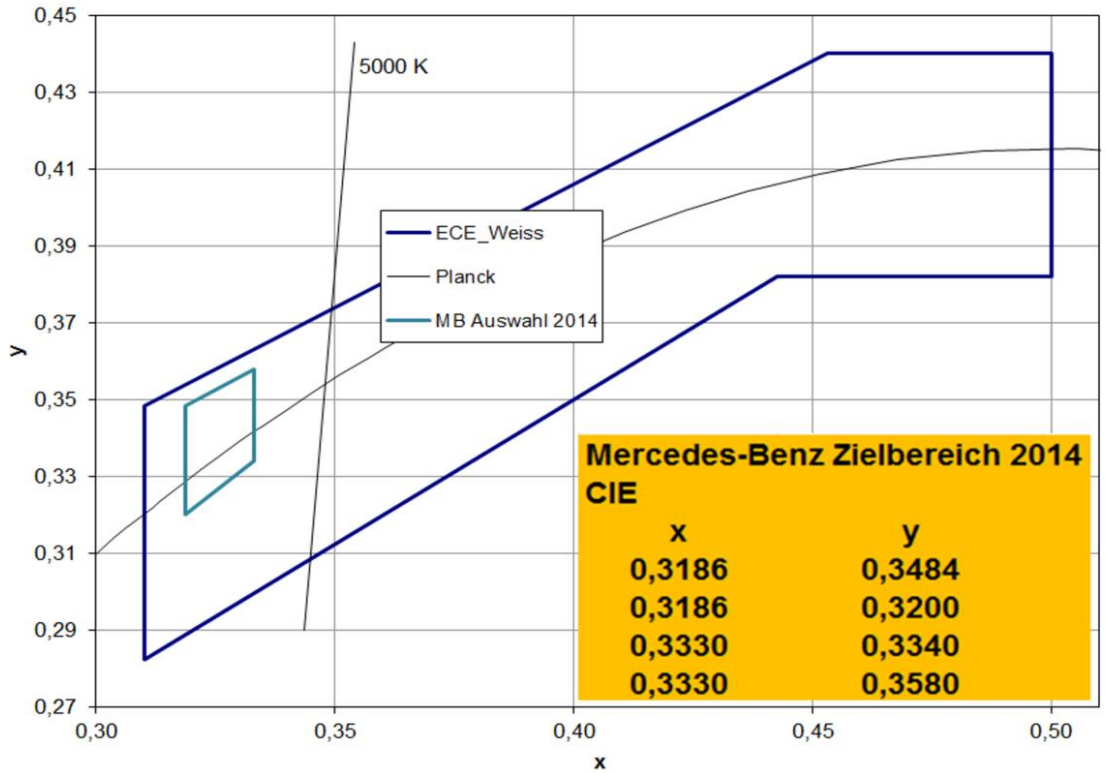

2141388
FI_LT-676

For functions with fiber-optic technology, optical lenses, or similar, the color influence of the material used shall be taken into account.

2.1.14.5.4.2 Photometric Requirements (2141391)

2141394
FI_LT-679

The following requirements are necessary for adequate and uniform illumination of the rear-view camera.

2141390
FI_LT-681

In addition to all legal requirements, the following luminous intensity values shall be complied with for the reversing light:

<p>Mercedes-Benz - Confidential -</p>	<p>Schutzvermerk DIN ISO 16016 beachten! /Refer to protection notice DIN ISO 16016! Keine Aenderung ohne Zustimmung der federfuehrenden Konstruktion / Any alterations are subject to the approval of the design department</p>	<p>Bearb./auth.: Hans Peter Schiffert Abt./dep.: RD/KEL Datum/date: 2022-07-25</p>
	<p>Technical Component Requirement Specifications Tail lamp QEV 111 AJPNLG</p>	<p>Requirement Specifications 001 version: Seite/page: 79 of 220</p>

Anforderungs-Bereich für die Rückfahrkamera

		Lichtstärke in cd						
		30 out	20 out	10 out	V	10 in	20 in	30 in
10 down	min		50	80	80	80	50	
	max		300	300	300	300	300	
15 down	min		30		30		30	
	max		300		300		300	
25 down	min	12			12			12
	max	300			300			300

2141393
FI_LT-680

For the calculation of the minimum light intensity (cd) of the tail lamp for the relevant range for the rear-view camera, a minimum illumination value of 3 lux is used as the basis at distances of 150 (25D), 300 (15D) and 500 cm (10D) behind the vehicle.

2141392
FI_LT-682

The reversing light shall have a homogeneous appearance (no dot formation or striation) or feature color projections (e.g. red stripes) on the road behind the vehicle. In the event of a deviation due to the structure and design, the supplier shall present design optimization proposals and agree on these with Mercedes-Benz AG.

2.1.14.5 Requirements for the Reflex / Side Reflex (3127941)

3128619

All photometric values of the lamp shall be at least 30% above the legal minimum values for the individual points or groups.

2.1.14.6 Camouflage (2141401)

2141403
FI_LT-689

The supplier shall have sent a camouflage proposal including illumination engineering simulations to the Mercedes-Benz AG Illumination Engineering representative at the latest 8 weeks before the off-tool parts deadline.

2141402
FI_LT-690

The camouflage proposal shall have an optimized design with regard to the covering of design-relevant surfaces. Photometrically effective surfaces may only be concealed to the extent that all legal light values remain fulfilled. If the legal light values are not even fulfilled without camouflage at this point in time, these values shall not be negatively affected by the camouflage.

2.1.15 Requirements from Testing (4056733)

2.1.15.1 General (4056734)

4058497

All knowledge documented in this context must not be passed onto third parties.

Mercedes-Benz - Confidential -	<small>Schutzvermerk DIN ISO 16016 beachten! /Refer to protection notice DIN ISO 16016! Keine Aenderung ohne Zustimmung der federführenden Konstruktion / Any alterations are subject to the approval of the design department</small>	Bearb./auth.: Hans Peter Schiffert Abt./dep.: RD/KEL Datum/date: 2022-07-25 Requirement Specifications version: 001 Seite/page: 80 of 220
	Technical Component Requirement Specifications Tail lamp QEV 111 AJPNLG	

2.1.15.1.1 Deadlines and Project Procedure (4056742)

- 4058498 All tests shall be completed positively, at the latest for sampling, with a parts status that is fit for series production (series-production site, series production, series-production material, C-sample PCBs, etc.).
- 4058500 For concept review 1 (KR2), the contractor shall have provided all tests in Duke (Mercedes-Benz tool) with the planned test dates
- 4058501 For test review 1 (ER1), the minimum scope agreed on with the client shall be performed and documented in Duke
- 4058502 For test review 2 (ER2), the first test iteration shall be fully carried out and documented in Duke

2.1.15.1.2 Test Documentation (4056746)

- 4058504 A test report shall be created and documented for each test performed. This test report shall contain at least one test date, the Mercedes-Benz item number, the E/Q status or sample status of the PCBs, photos of the component (before, during, and after the test, noticeable problems, etc.), test results (explicit list of the required parameter tests, visual inspections, etc.) and a final evaluation (red, yellow, green)

2.1.15.1.2.1 Documentation of Development Activities in Duke (4056993)

- 4058512 *The client will operate a central system for the documentation of the development activities during the maturity level process.*
- 4058513 *The central system is called Duke (Testing and Validation).*
- 4058514 *Duke is the infrastructure specified by the client for the joint documentation of the development activities with the contractor.*
- 4058515 *Duke is an internal user program for the documentation and tracking of all development activities incl. tests along the MDS (Mercedes-Benz Development System). The program controls the validation of the component maturity level from the early digital phases to the end of production.*
- 4058516 Duke has several technical interfaces. At the start of the project, the contractor shall clarify which interfaces will be used with the client. The contractor shall use the Duke technical interfaces defined by the client.
- 4058517 In the "Test library" module, the contractor shall create all RD requirements from the corresponding component requirement specifications or function specification after prior specification and discussion with the client.
- 4058518 In the "Planning" module, the contractor performs in consultation with the client the scheduling, documentation, and evaluation of the requirements from the requirement specifications.

Mercedes-Benz - Confidential -	Schutzvermerk DIN ISO 16016 beachten! /Refer to protection notice DIN ISO 16016! Keine Aenderung ohne Zustimmung der federfuehrenden Konstruktion / Any alterations are subject to the approval of the design department	Bearb./auth.: Hans Peter Schiffert Abt./dep.: RD/KEL Datum/date: 2022-07-25 Requirement Specifications 001 version: Seite/page: 81 of 220
	Technical Component Requirement Specifications Tail lamp QEV 111 AJPNLG	

- 4058519 The contractor shall create and document identified faults and related introduced measures in the "Topics & Measures" module and process and provide feedback on these after assignment by the department.
- 4058520 The contractor shall regularly and promptly provide feedback on the processing state of faults to the client via the "Topics & Measures" module in DukE. The timeframe regarding feedback shall be agreed on at the start of the project with the component manager.
- 4058521 For all documented component parts tests and faults, the contractor shall ensure that the respective component part/software version is documented in DukE.
- 4058522 The contractor shall receive and process faults identified by the client via the supplier interface in DukE. The precise procedure shall be agreed on at the start of the project between the client and contractor.
- 4058523 RD development activities started by the contractor shall be immediately documented in the system. The client shall be informed at all times about the status of the development activities.
- 4058524 The acceptance of services by the client is performed based on the results and verifications documented in DukE.
- 4058525 The access to DukE takes place via an external connection. The connection will be set up by the client.

2.1.15.2 Conducting Tests (4056992)

- 4622567 All tests shall be performed in accordance with the corresponding test standards. Deviations have been described below.
- 4058527 Unless otherwise specified, all tests shall be performed on a fully assembled signal lamp
- 4058528 One set of components shall be tested per variant
- 4058529 The taking over of the test results for signal lamps and national versions shall be agreed on with the client.
- 4058530 To ensure that the testing accuracy of the tests corresponds to the real requirements in the field, it shall be ensured that the installation location, screwdriving sequence, and screw-on torque of the component in the vehicle are in general reproduced when the tests are conducted.

2.1.15.2.1 General Specifications for Test Frames (4056994)

- 4058531 To obtain uniform test results, the contractor and client shall use the same test frames from the same manufacturer for the tests.
- 4058533 The contractor and client shall agree on the test frames before their production.

Mercedes-Benz - Confidential -	<small>Schutzvermerk DIN ISO 16016 beachten! /Refer to protection notice DIN ISO 16016! Keine Aenderung ohne Zustimmung der federfuehrenden Konstruktion / Any alterations are subject to the approval of the design department</small> Technical Component Requirement Specifications Tail lamp QEV 111 AJPNLG	Bearb./auth.: Hans Peter Schiffert Abt./dep.: RD/KEL Datum/date: 2022-07-25 Requirement Specifications 001 version: Seite/page: 82 of 220
---	---	--

- 4058534 The base plate shall be made of aluminum.
- 4058535 The edges of the base plate shall be chamfered.
- 4058536 The grid lines shall be milled and marked on the base plate (X, Y) and on the device under test mount (Z).
- 4058537 A measurement report shall be compiled on the position deviation (X, Y, Z) of the bolting points for the lamp support relative to the data.
- 4058538 The base plate shall be at least 12 mm thick and max. 500 x 360 mm large (so that it matches the component part).
- 4058539 The side edges shall be at an exact right angle to the front edge and parallel to the vehicle network.
- 4058540 The model designation (e.g. 222), the installation side (left or right), and an installation height to be agreed on with the client (measured from the base plate upper edge to the ground) shall be milled into the base plate.
- 4058541 The max. gross weight of a component frame shall not exceed 15 kg.
- 4058543 The max. gross weight of a continuous reflector strip shall not exceed 30 kg.
- 4058544 *The function of the test frame takes priority over the weight; if the weights are exceeded, the client shall be consulted.*
- 4058545 Non-rusting screws shall be used.
- 4058546 In the case of plastic test frames, these shall be milled so that they have a single-piece design. Bonded joints are not permissible.
- 4058547 Threaded inserts made of stainless metal shall be used for plastic frames.

2.1.15.2.1.1 Specifications for the Environmental Test Frames (4056995)

- 4058549 A 45 mm x 45 mm borehole grid (bore 10 mm), starting from the left side and the front edge +5 mm, shall be incorporated in the base plate. This grid shall be continued in the case of multipiece test frames.
- 4058550 For the gap dimension, environmentally resistant milled markings shall be applied at the respective points (in coordination with the client).
- 4058551 The test frame shall be designed so that the DUT lies in the center of gravity of the Z-center axis of the clamping plate. The position of the hole grid on the test frame base plate shall be adapted accordingly.
- 4058552 The test frame shall be designed such that natural vibrations do not negatively affect the frame or the DUT and/or the required load profile can be carried out without damaging the frame.
- 4058553 The DUT surroundings shall be mapped authentically (surrounding joint gap dimension, lamp surround incl. seam sealing, etc.).

Mercedes-Benz - Confidential -	<small>Schutzvermerk DIN ISO 16016 beachten! /Refer to protection notice DIN ISO 16016! Keine Aenderung ohne Zustimmung der federfuehrenden Konstruktion / Any alterations are subject to the approval of the design department</small>	Bearb./auth.: Hans Peter Schiffert Abt./dep.: RD/KEL Datum/date: 2022-07-25 Requirement Specifications 001 version: Seite/page: 83 of 220
	Technical Component Requirement Specifications Tail lamp QEV 111 AJPNLG	

- 4058554 The bolting points shall be represented using exchangeable inserts.
- 4058555 A cover shall be provided for exposed areas (e.g. plugs, fastening points).
- 4058556 A removable, circumferentially sealed Plexiglas pane shall seal off the rear area of the DUT mount from dust and water.
- 4058557 Washers (stainless) shall be used to attach the Plexiglas pane.
- 4058558 Ethanol-resistant Plexiglas shall be used.

2.1.15.2.1.2 Specifications for Test Frames for Photometric Tests (4056997)

- 4058560 The bolting points shall be exact to $\pm 5/100$ mm (relative to the data).
- 4058561 For two-piece rear lamps (e.g. sidewall lamp and rear-end door lamp/luminescent band), a clear presentation of the overall lamp in the original installation condition shall be possible.
- 4058562 The bore of the fastening holes for the goniometer mount shall be 10 mm and be designed in accordance with the following diagram.

4139533

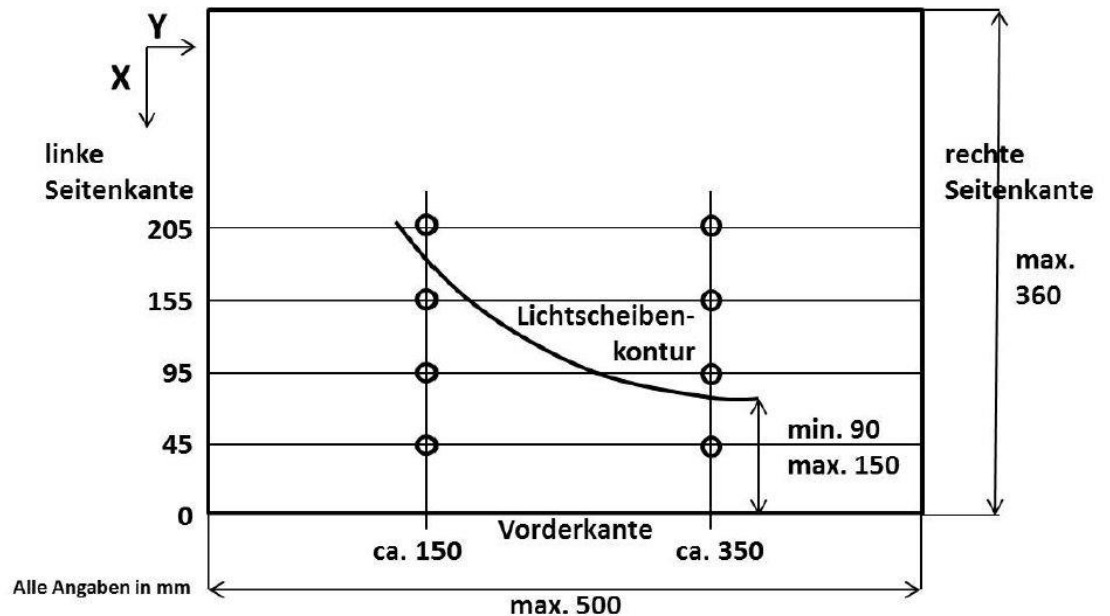

- 4058564 *If the mounting holes are covered up, this can then be shifted in the Y-direction.*
- 4058565 The bores shall have a minimum clearance of 25 mm with respect to the bodies.
- 4058566 So that the base plate does not impair the light functions, the rear lamp shall be vertically positioned in accordance with the following diagram. All angles $\alpha \geq 30^\circ$ shall be possible. In this connection, the distance between the floor plate and the rear lamp lower edge shall be designed accordingly.

Mercedes-Benz - Confidential -	Schutzvermerk DIN ISO 16016 beachten! / Refer to protection notice DIN ISO 16016! Keine Aenderung ohne Zustimmung der federfuehrenden Konstruktion / Any alterations are subject to the approval of the design department	Bearb./auth.: Hans Peter Schiffert Abt./dep.: RD/KEL Datum/date: 2022-07-25 Requirement Specifications 001 version: Seite/page: 84 of 220
	Technical Component Requirement Specifications Tail lamp QEV 111 AJPNLG	

4139534

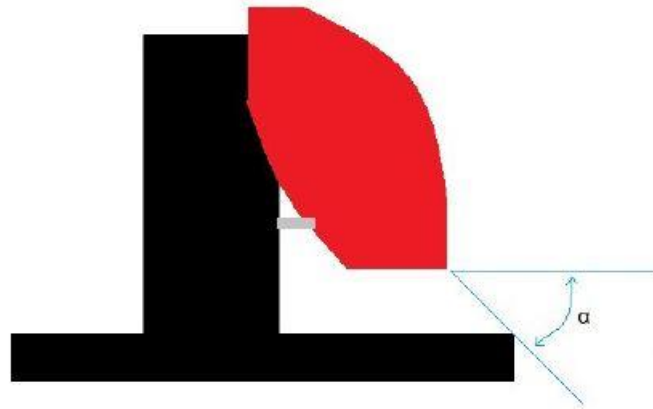

5100348

A fixture shall be provided for mounting the rack on the robot goniometer. The hole grid shall be adopted according to the following sketch. The center point (see 1) shall correspond to the center point of the lamp in the Z-axis direction.

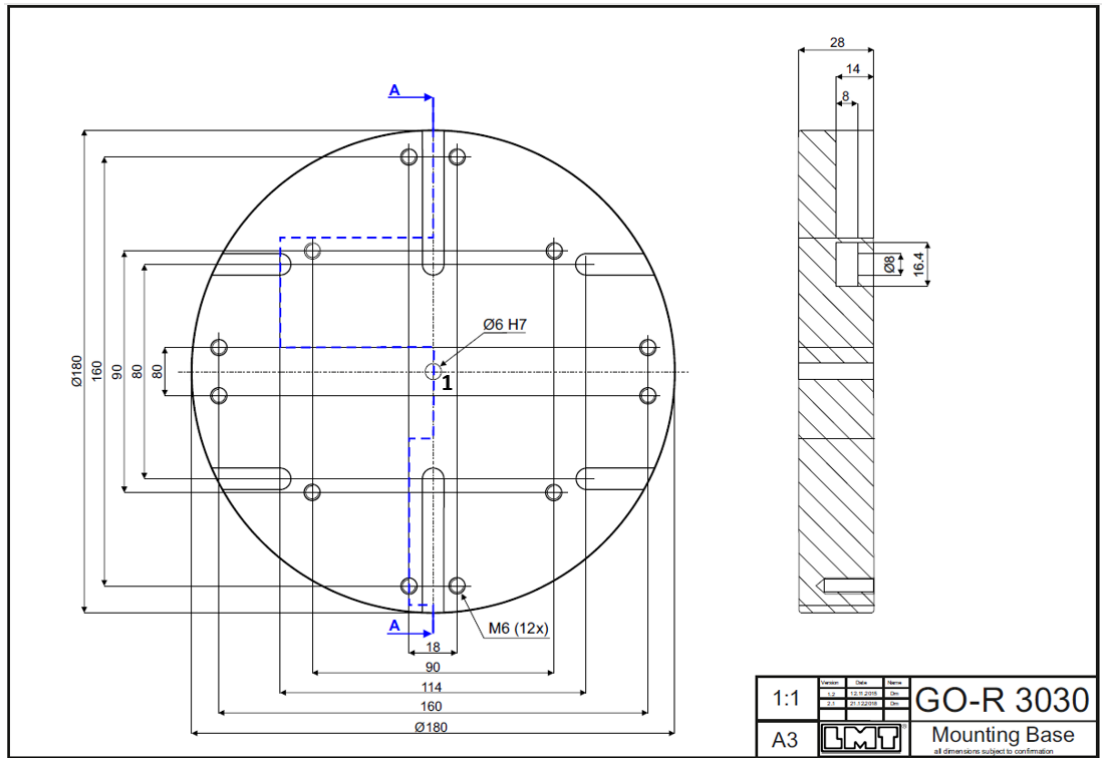

2.1.15.2.1.3 Specifications for the Bracket (4086208)

4086209

A bracket shall be able to accommodate the lamp at its bolting points in the installation position.

<p>Mercedes-Benz - Confidential -</p>	<p>Schutzvermerk DIN ISO 16016 beachten! /Refer to protection notice DIN ISO 16016! Keine Aenderung ohne Zustimmung der federfuehrenden Konstruktion / Any alterations are subject to the approval of the design department</p> <p>Technical Component Requirement Specifications Tail lamp</p> <p>QEV 111 AJPNLG</p>	<p>Bearb./auth.: Hans Peter Schiffert Abt./dep.: RD/KEL Datum/date: 2022-07-25 Requirement Specifications version: 001 Seite/page: 85 of 220</p>
---	---	--

2.1.15.2.2

Simulation of the Actuation of the Signal Lamps with PWM (4057001)

4076360

If the actuation of the light function is to be carried out via PWM, the test can be performed with a corresponding simulation.

4076361

If the corresponding parameters Z (PWM time on), F (frequency), and Umax are configured, the effective voltage is as in the following table (applies for PWM only). All other parameter details are available in the MBN 10567. (Number of cycles, pause between cycles, rise & fall time, temperature, voltage tolerances, etc.). All functions are permanently on (not flashing on and off). The individual light functions may be tested in succession, provided that the light functions are not combined on one PCB.

4076432

[MBN10567] Tests	F (frequency)	Z (PWM time ON)	V (delay)	Ueff	T (test duration)	Umax	Umin
Long-term overvoltage	8 ms (125 Hz)	4.6 ms	1000 ms	12.8 V	60 min.	17 V	13.5 V
Trans. Overvoltage	8 ms (125 Hz)	4.6 ms	150 ms	Var.	Var.	18 V	16 V
Jump start	8 ms (125 Hz)	3.2 ms	150 ms	16.44 V	60 sec	26 V	10.8 V
Load dump	8 ms (125 Hz)	3.2 ms	150 ms	20,24	300 ms (x10)	32 V	13.5 V

4139535

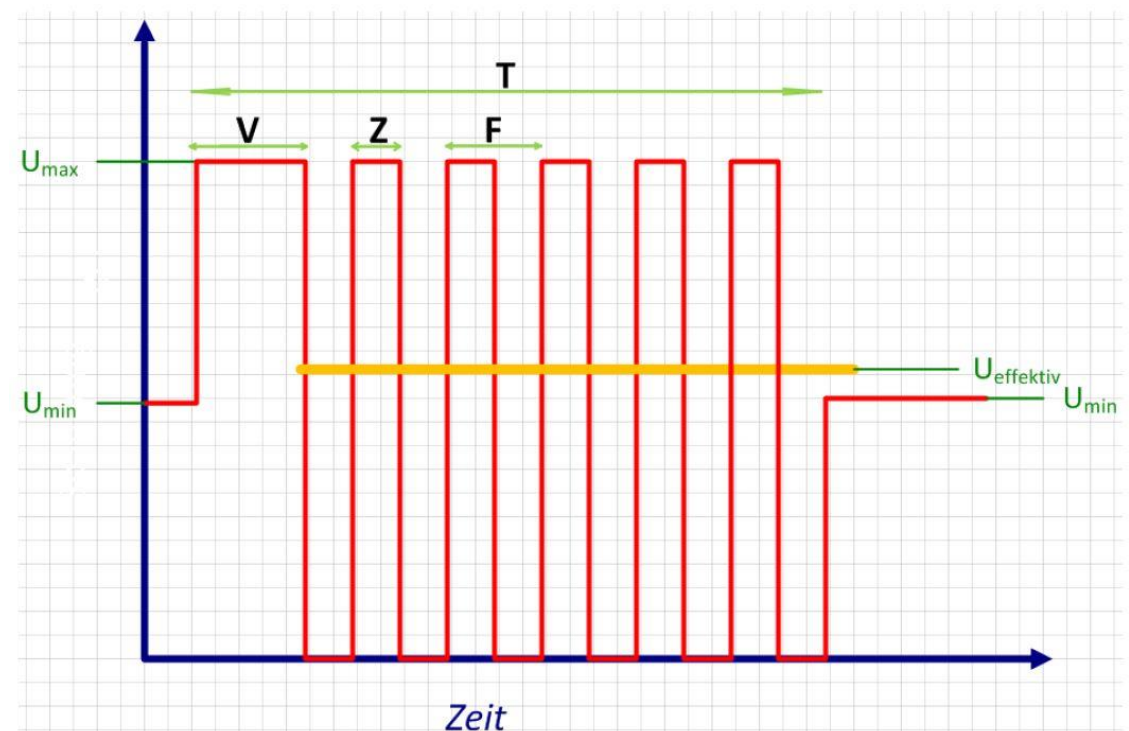

<p>Mercedes-Benz - Confidential -</p>	<p><small>Schutzvermerk DIN ISO 16016 beachten! / Refer to protection notice DIN ISO 16016! Keine Aenderung ohne Zustimmung der federfuehrenden Konstruktion / Any alterations are subject to the approval of the design department</small></p> <p>Technical Component Requirement Specifications Tail lamp</p> <p>QEV 111 AJPNLG</p>	<p>Bearb./auth.: Hans Peter Schiffert Abt./dep.: RD/KEL Datum/date: 2022-07-25 Requirement Specifications version: 001 Seite/page: 86 of 220</p>

2.1.15.2.3 Function Classes (4057002)

- 4058572 Function class 2 (safety-relevant functions): Tail lamp, brake light, turn indicators, and rear fog light
- 4058573 Function class 3 (functions required for vehicle operation): Reversing light, license plate lamp, and high-mounted brake lamp

2.1.15.2.4 Functional States (4057003)

4062235 The following functional states apply for the component:

Function state	Additional description
A	<p><u>Resistor circuit:</u> The brightness may slightly decrease/increase for the duration of the test pulse. The light functions shall not go out.</p> <p><u>Constant-current circuit / taillight actuation module / integrated tail lamp:</u> 10 V - 15 V: No change in brightness permitted 8 V - 10 V and 15 V - 17 V: The brightness may slightly decrease/increase for the duration of the test pulse. The light functions shall not go out. A photometric evaluation is carried out together with the client.</p>
C	<p><u>Resistor circuit:</u> The brightness may slightly decrease/increase for the duration of the test pulse. The light functions shall not go out.</p> <p><u>Constant-current circuit / taillight actuation module / integrated tail lamp:</u> 10 V - 15 V: No change in brightness permitted 8 V - 10 V and 15 V - 17 V: The brightness may slightly decrease/increase for the duration of the test pulse. The light functions shall not go out. A photometric evaluation is carried out together with the client.</p>

2.1.15.2.5 Operating Modes (4057004)

4058574 The "Driving" and "Off-Grid Parking" operating modes apply

2.1.15.2.6 Operating Modes (4057005)

4058575 The contractor shall define the relevant parameters (such as, e.g. operating current, supply voltages, input signals, etc.) specifying the tolerances for all operating modes;

<p>Mercedes-Benz - Confidential -</p>	<p><small>Schutzvermerk DIN ISO 16016 beachten! /Refer to protection notice DIN ISO 16016! Keine Aenderung ohne Zustimmung der federfuehrenden Konstruktion / Any alterations are subject to the approval of the design department</small></p> <p>Technical Component Requirement Specifications Tail lamp QEV 111 AJPNLG</p>	<p>Bearb./auth.: Hans Peter Schiffert Abt./dep.: RD/KEL Datum/date: 2022-07-25 Requirement Specifications 001 version: Seite/page: 87 of 220</p>

these shall be coordinated with the client and documented.

4062237

Operating Mode (MBN 10306)	Operating Mode (MBN 10567)	Additional description
not installed	I.a	-
Vehicle assembly Operation _{min} Off-grid parking _{min}	I.b	-
-	II.a	Circuit 30 supplied with power, without active light function
Driving _{min}	II.b	Tail lamp active. Actuation in accordance with E/E slides
Operation _{max} Driving _{max}	II.c	All light functions active in accordance with the switching profile. Actuation in accordance with E/E slides.

2.1.15.2.7 Switching Profiles (4057006)







4058576

The switching profile shall be drawn on for the operating statuses Operation_{max} and Driving_{max} or II.c.

4058577

The profile repeats itself after a duty cycle of 60 min

4139536

Schlusslicht		60min an
Sidemarker		60min an
Kennzeichenleuchte		60min an
Bremslicht		15min an
Fahrtrichtungsanzeiger		5min an
Rückfahrlicht		1min an
Nebelschlusslicht		1min an

2.1.15.2.8 Key Parameters of Parameter Tests (4057007)

4058579

Min./max. power consumption of individual light functions

Mercedes-Benz - Confidential -	<small>Schutzvermerk DIN ISO 16016 beachten! /Refer to protection notice DIN ISO 16016! Keine Aenderung ohne Zustimmung der federfuehrenden Konstruktion / Any alterations are subject to the approval of the design department</small> Technical Component Requirement Specifications Tail lamp QEV 111 AJPNLG	Bearb./auth.: Hans Peter Schiffert Abt./dep.: RD/KEL Datum/date: 2022-07-25 Requirement Specifications version: 001 Seite/page: 88 of 220

4058581 The parameter test (large) shall be performed only at room temperature

2.1.15.2.9 Continuous Parameter Monitoring (4058586)

4198189 Fault messages on the bus

2.1.15.2.10 Leaktightness (4086263)

4086358 In addition to the requirements of MBN 10306, the leak test shall be performed as follows:

4086264 The limit leak rate shall be max. 1 mbar/s, at a test pressure of 60 mbar and a pressure-holding duration of 10 s. Possibly present sealing elements in the surroundings are not considered.

4086353 During the test, the electric lines shall be deflected to the left and right at the connector to the maximum possible extent and held for 5 s each.

2.1.15.2.11 Visual Inspection (4057008)

4058582 In addition to the visual inspection in accordance with DIN EN 13018, no deformations, cracks, deposit formations, blistering, iridescence, discolorations, cloudiness, condensation, abrasion, sink spots, or other changes shall occur

4058583 *The exceptions to this complementary requirement are the following test scopes: K-16, L-02 and sequence progression.*

2.1.15.2.12 Physical Analysis (4057009)

4058589 In addition to the requirements of MBN 10306, the physical analysis shall be performed as follows:

4058590 *Before opening the component:*

4058591 Applies only for non-approved plug contacts: An inspection of the entire connector connection (e.g. requirements/ tolerances of implementation regulation, normal contact forces, volume resistance) shall be carried out

4058592 The lamps must form a homogeneous luminous image. There must be no perceptible differences in color and brightness of different LEDs. This shall be documented accordingly and evaluated with the client.

4058593 No rattling, creaking or other noises shall occur.

5685548 The component shall not exhibit any fractures (including white fractures).

4058594 The contact surfaces of the electrical contact pairings shall not exhibit any traces of abrasion or wear nor any other impairments.

Mercedes-Benz - Confidential -	<small>Schutzvermerk DIN ISO 16016 beachten! / Refer to protection notice DIN ISO 16016! Keine Aenderung ohne Zustimmung der federfuehrenden Konstruktion / Any alterations are subject to the approval of the design department</small>	Bearb./auth.: Hans Peter Schiffert
	Technical Component Requirement Specifications Tail lamp QEV 111 AJPNLG	Abt./dep.: RD/KEL Datum/date: 2022-07-25 Requirement Specifications 001 version: Seite/page: 89 of 220

- 4058595 The clip function shall not be weakened after exposure to the load (no crazing, fracture, or other weakening may be identifiable).
- 4058596 *After opening the component:*
- 4058597 The internal connecting cables, PCBs, and connections shall be checked for abrasion/damage.
- 4077942 It shall be checked whether an interaction occurred between any tapes used and the internal cables.
- 4058598 The conductor tracks, individual sockets and the plug connections shall not exhibit any signs of contact corrosion.
- 5685564 The component shall not exhibit any fractures (including white fractures).
- 4058599 After being exposed to loads and stresses, the clips' function may not be weakened. (no crazing, break or any other type of weakening should be detected).

2.1.15.3 Tests in accordance with MBN 10567 (4057010)

4622562 Only the following tests from MBN 10567 shall be carried out.

4062248

Test	Additional description
Operating voltage range test	-
Long-term overvoltage test	-
Transient overvoltage test	-
Transient undervoltage test	Severity level 2: Functional state C
Jump start test	-
Load dump test	-
Superimposed alternating voltage test	-
Slow decrease and increase of the supply voltage test	Only if ICs and/or transistors are used
Start pulses test	-
Reset behavior test	Only if ICs and/or transistors are used
Short interruptions test	-
Pin interruption test	-
Connector interruption test	-
Polarity reversal test	-

Mercedes-Benz - Confidential -	<small>Schutzvermerk DIN ISO 16016 beachten! / Refer to protection notice DIN ISO 16016! Keine Aenderung ohne Zustimmung der federfuehrenden Konstruktion / Any alterations are subject to the approval of the design department</small>	Bearb./auth.: Hans Peter Schiffert Abt./dep.: RD/KEL Datum/date: 2022-07-25 Requirement Specifications version: 001 Seite/page: 90 of 220
	Technical Component Requirement Specifications Tail lamp QEV 111 AJPNLG	

2.1.15.4

Tests in accordance with MBN 10384 (4084973)

4084974

Only the following tests from MBN 10384 shall be carried out.

4622560

Test		Additional description
PG 0	Incoming test	-
PG 1	Dimensions	-
PG 2	Material and surface analysis, contacts	-
PG 3	Material and surface analysis, housings and single-wire seal	-
PG 7	Handling and functional reliability of the housings	Without E7.3
PG 12	Current heating, derating	-

2.1.15.5

Tests in accordance with MBN 10306 (4057016)

4293536

Only the following tests from MBN 10306 shall be carried out.

4062260

Test		Additional description	Installation situation
M-03	Dust test	-	Environmental test frame
M-04	Vibration Test	Profile D	Environmental test frame
M-05	Mechanical shock	Peak acceleration: 300m/s ²	Environmental test frame
M-06	Mechanical shock endurance	Shock axis for components in rear-end door: X Shock axis for components in trunk lid: Z	Environmental test frame
K-01	High/low temperature storage	-	-
K-05	Thermal shock (component)	-	Brackets
K-06	Salt Spray Test, Operating, Exterior	To be carried out with enclosed lamps	Environmental test frame
K-07	Salt spray test, operating, interior	To be carried out with lamps open to the vehicle interior	Environmental frame without rear seal
K-09	Damp heat, cyclic (with frost)	In addition, a test run (including upstream K-01)	Environmental test frame

<p>Mercedes-Benz - Confidential -</p>	<p><small>Schutzvermerk DIN ISO 16016 beachten! / Refer to protection notice DIN ISO 16016! Keine Aenderung ohne Zustimmung der federfuehrenden Konstruktion / Any alterations are subject to the approval of the design department</small></p> <p>Technical Component Requirement Specifications Tail lamp QEV 111 AJPNLG</p>	<p>Bearb./auth.: Hans Peter Schiffert Abt./dep.: RD/KEL Datum/date: 2022-07-25 Requirement Specifications 001 version: Seite/page: 91 of 220</p>

		shall be performed outside the sequence test	
K-10	Water Protection - IPX0 to IPX6K	To be carried out with enclosed lamps	Environmental test frame
K-14	Damp heat, steady state	-	Brackets
K-16	Thermal Shock (without Housing)	-	PCBs with wiring harness
K-18	Corrosion test with flow of mixed gas	-	Brackets
L-02	High-temperature endurance test	-	Brackets
L-03	Temperature cycle endurance test	-	Brackets

2.1.15.5.1 Deviating Test Scopes (4057022)

2.1.15.5.1.1 High-pressure Cleaning Test (4057023)

4293542 The test replaces the "K-11 High-Pressure/Steam-Jet Cleaning" test and shall be carried out in accordance with the test sequence plan of MBN 10306.

4058614 *Purpose:*

4058615 *The test simulates the exposure of the component to water during vehicle cleaning. It is used to validate the component leaktightness as well as the seal to adjacent component parts during high-pressure/steam jet cleaning.*

4058616 *Test:*

4058617 *A differentiation is made between a warm water and cold water test.*

4058618 The test shall be performed on the environmental test frame. In addition to the nominal joint, a maximum joint (according to RFQ drawing) shall also be validated using a correspondingly modified DUT.

4058619 The steam cleaner shall be brought to operating temperature before use

4058620 For the test, the nozzle shall be at a distance of 20 cm to the component parts (for better reproducibility, a distance gage shall be used on the spray lance)

4058621 The DUT shall be exposed to water all around with a high-pressure lance with flat-spray nozzle positioned transverse to the gap (between rear lamp and bodyshell); this exposure shall be carried out as vertically as possible to the surface normal of the aimed-at lamp surface. In doing so, the gap shall be moved over with the center of the flat spray. A uniform movement of 20 cm +5 cm in 10 seconds shall be maintained. The test duration for a complete cycle shall be documented.

4058622 The DUT shall be exposed to water all around with a high-pressure lance with flat-

Mercedes-Benz - Confidential -	<small>Schutzvermerk DIN ISO 16016 beachten! /Refer to protection notice DIN ISO 16016! Keine Aenderung ohne Zustimmung der federfuehrenden Konstruktion / Any alterations are subject to the approval of the design department</small>	Bearb./auth.: Hans Peter Schiffert Abt./dep.: RD/KEL Datum/date: 2022-07-25 Requirement Specifications version: 001 Seite/page: 92 of 220
	Technical Component Requirement Specifications Tail lamp QEV 111 AJPNLG	

spray nozzle positioned longitudinally to the gap (between rear lamp and bodyshell); this exposure shall be carried out as vertically as possible to the surface normal of the aimed-at lamp surface. A uniform movement of 20 cm +5 cm in 10 seconds shall be maintained. The test duration for a complete cycle shall be documented.

4058623

A total of three transverse passes each, then three longitudinal passes each shall be performed in succession.

4058624

Warm water test:

Operating mode	Off-Grid Parking _{min}
Fuel quantity delivered	1200 l/h
Water pressure	100 bar (measured at nozzle outlet)
Water temperature	80_ °C

4064655

Cold water test:

Operating mode	Off-Grid Parking _{min}
Fuel quantity delivered	1200 l/h
Water pressure	100 bar (measured at nozzle outlet)
Water temperature	15 °C - 25 °C
Air temperature in the lamp	Water temperature + min. 20 °C

4058625

Requirement:

4058627

Water ingress between the bodyshell and seal or lamp and seal is not permitted. The verification is realized via a visual inspection.

4058628

Water ingress into the lamp is not permitted. The verification is provided via a visible inspection and a leak test

2.1.15.6 Additional Test Scopes (4057025)

2.1.15.6.1 Mechanical vibration test

5685477

The test shall be performed in accordance with MBN10438 "Mechanical Vibration Requirements (Broadband Noise) for

Detachable Body Parts on Passenger Cars.

5685476

Purpose:

The test simulates the vibration stress of the component during vehicle operation.

<p>Mercedes-Benz - Confidential -</p>	<p><small>Schutzvermerk DIN ISO 16016 beachten! /Refer to protection notice DIN ISO 16016! Keine Aenderung ohne Zustimmung der federfuehrenden Konstruktion / Any alterations are subject to the approval of the design department</small></p> <p>Technical Component Requirement Specifications Tail lamp QEV 111 AJPNLG</p>	<p>Bearb./auth.: Hans Peter Schiffert Abt./dep.: RD/KEL Datum/date: 2022-07-25 Requirement Specifications 001 version: Seite/page: 93 of 220</p>

5685474

Test:

The test shall be performed in the environmental test frame.

The following test spectra apply:

- PSD_horizontal_longitudinal_X
- PSD_horizontal_transverse_Y
- PSD_vertical_Z

A test duration of 16 h/axle applies.

In deviation from MBN10438, the temperature distribution profile defined for the component in MBN10306 shall apply.

5685480

Requirement:

The DUT shall be fully operable before and after the test. Verification is carried out by means of a leaktightness and visual inspection as well as a physical analysis.

2.1.15.6.2

Sound System Test (4057031)

4065683

Purpose:

4065684

The test is to validate the component behavior against vibrations due to excitation by a sound system installed in the vehicle with high output,.

4065685

Test:

4065686

The component shall be tested in the environmental test frame at room temperature. In doing so, the profile shall be run through three times

<p>Mercedes-Benz - Confidential -</p>	<p style="font-size: small;">Schutzvermerk DIN ISO 16016 beachten! /Refer to protection notice DIN ISO 16016! Keine Aenderung ohne Zustimmung der federfuehrenden Konstruktion / Any alterations are subject to the approval of the design department</p> <p style="text-align: center;">Technical Component Requirement Specifications Tail lamp QEV 111 AJPNLG</p>	<p>Bearb./auth.: Hans Peter Schiffert Abt./dep.: RD/KEL Datum/date: 2022-07-25 Requirement Specifications 001 version: Seite/page: 94 of 220</p>
---	---	--

4139541

x-Achse		y-Achse		z-Achse	
Frequenz	Beschleunigung	Frequenz	Beschleunigung	Frequenz	Beschleunigung
[Hz]	[g]	[Hz]	[g]	[Hz]	[g]
50	0,132	50	0,288	50	0,215
60	0,69	60	1,361	60	1,31
70	0,69	70	1,361	70	1,31
80	0,63	80	0,844	80	0,635
90	0,63	90	0,844	90	0,635

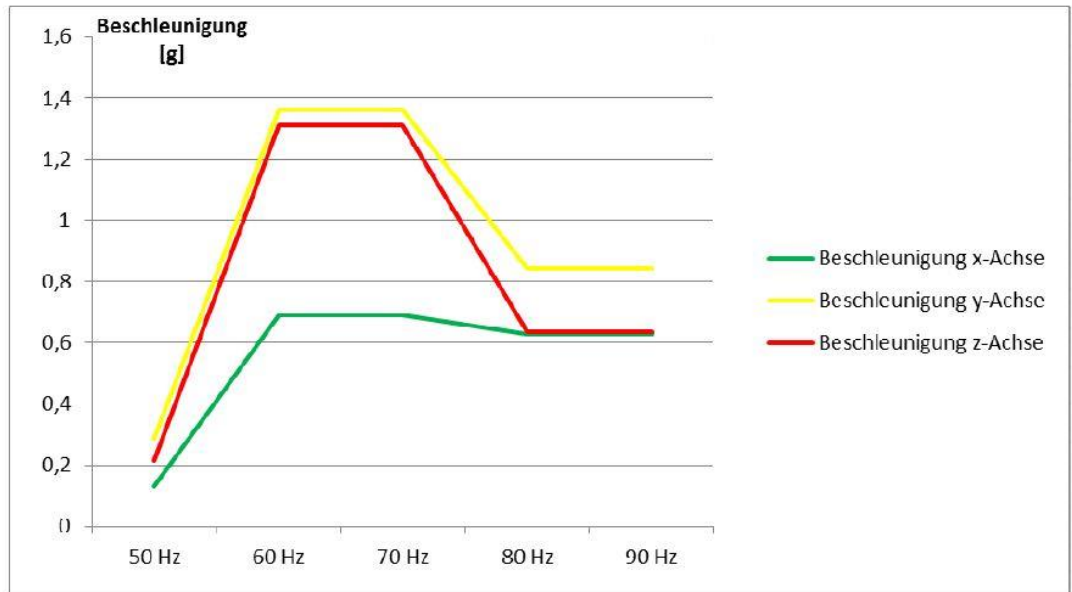

4065687

Requirement:

4065689

The lamp, its component parts, and connection shall not generate any noises during the test (e.g. clattering, cracking, natural frequency noises, vibrations of component parts/PCBs, etc.)

2.1.15.6.3

Push Test (4057032)

4065948

Purpose:

4065951

The test is intended to ensure the resistance of the lens and weld seam to possible damage.

4065952

Test:

4065953

Two complete sets of lamps per variant shall be tested in each case in the environmental frame. The test specimen presses on the lens of the lamp with a defined test force of 400 N.

Mercedes-Benz - Confidential -	<small>Schutzvermerk DIN ISO 16016 beachten! / Refer to protection notice DIN ISO 16016! Keine Änderung ohne Zustimmung der federführenden Konstruktion / Any alterations are subject to the approval of the design department</small>	Bearb./auth.: Hans Peter Schiffert Abt./dep.: RD/KEL Datum/date: 2022-07-25 Requirement Specifications version: 001 Seite/page: 95 of 220
	Technical Component Requirement Specifications Tail lamp QEV 111 AJPNLG	

4231420

An indenter with the dimensions 6 cm x 2 cm x 2 cm (W x H x D) shall be used as the test specimen. A closed-cell EPDM plate seal with a Shore A hardness of 50 and the dimensions 6 cm x 2 cm x 1 cm shall be used on this.

4139543

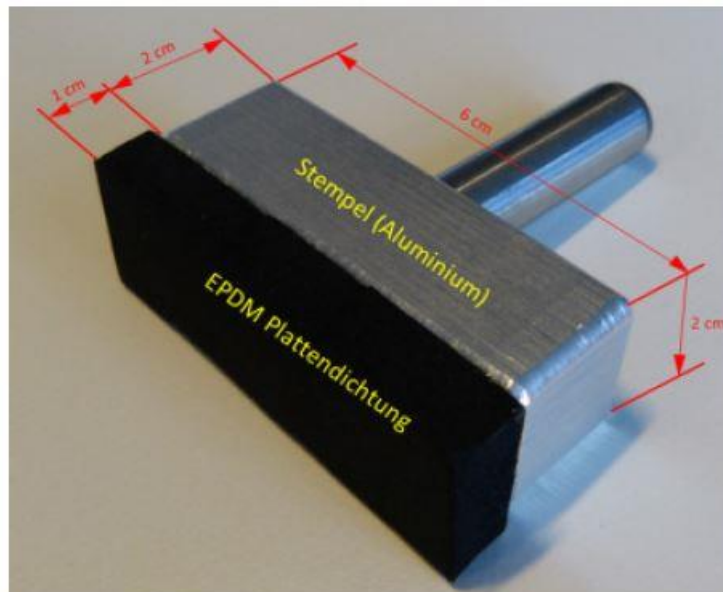

4066251

Requirement:

4066311

Upon first load, there shall not be any breaking of the lens or the welding rib or any other damage. This applies to application of force at any point on the scattering lens. Verification shall be provided via a visible inspection and a leak test

2.1.15.6.4

Electrostatic discharge – Handling additional test (ESDH/Z test) (4057033)

4076456

Purpose:

4076457

The test is intended to ensure the interference immunity of the component to electrostatic discharges during handling in accordance with ISO 10605.

4076458

Test:

4076459

The test setup is described in ISO 10605:2008-07, Section 9. The DUT is to be placed directly on the HCP. A conductible mat shall not be used. The ground pin is to be electrically connected over the shortest route to the HPC.

4076460

The DUT shall be tested at all discharge points and at all test voltages with positive and negative polarity using the number of discharges specified in each case. The discharge points shall be documented accordingly.

4076461

Discharge type: Reflector discharge point (secured, e.g. by opening the lens).

4076462

Contact discharge: 5 discharges ± 8 kV.

4076463

Discharge network: (ESDH/Z test): 150 pF / 330 Ω .

Mercedes-Benz - Confidential -	<small>Schutzvermerk DIN ISO 16016 beachten! / Refer to protection notice DIN ISO 16016! Keine Aenderung ohne Zustimmung der federfuehrenden Konstruktion / Any alterations are subject to the approval of the design department</small>	Bearb./auth.: Hans Peter Schiffert Abt./dep.: RD/KEL Datum/date: 2022-07-25 Requirement Specifications version: 001 Seite/page: 96 of 220
	Technical Component Requirement Specifications Tail lamp QEV 111 AJPNLG	

4076464

Requirement:

4076465

The DUT shall be fully functional before, during and after the test and all parameters shall meet the specifications. The verification is realized via a P-02 parameter test (small)

2.1.15.6.5

Test for Sink Marks (4057035)

4069375

Purpose:

4069465

The test is to ensure the resistance of the component to high temperatures.

4069489

Test:

4069509

The DUT shall be stored for 1 h following complete temperature adaptation (according to MBN10306), at a relative humidity of 15-25%, in the bracket at the corresponding storage temperature.

4069526

Storage temperature of taillight, outboard additional lamp (except STF), license plate lamp, molding: T=102°C

4069571

Requirement:

4069577

The DUT shall not exhibit any visual changes during and after the test. The verification is realized via a visual inspection.

2.1.15.6.6

Ethanol Test (4057036)

4070048

Purpose:

4070073

The test is to validate the resistance of the component to the ethanol/water mixture

4070086

Test:

4070097

Tests 1 and 2 shall each be performed on separate DUTs.

4070108

The test may be performed on a fully assembled signal lamp without electronics.

4070161

Test 1

The DUT shall be immersed for 15 min, lying horizontally with the lens facing downwards in an ethanol-water mixture (ratio 90:10). Afterwards, the DUT is dried off in stationary air for 30 minutes (horizontally positioned, lens facing upwards).

4070449

Test 2

While installed in the environmental test frame, the DUT shall be completely wetted at least 3 times via spraying with an ethanol-water mixture (ratio 90:10). After each wetting, wait until the ethanol/water mixture has fully dried. The DUT shall then be dried for 30 min in still air.

4070464

Requirement:

4070490

After 24 h, no crack formation and/or leaks may occur. Discolorations and dulling are

<p>Mercedes-Benz - Confidential -</p>	<p><small>Schutzvermerk DIN ISO 16016 beachten! /Refer to protection notice DIN ISO 16016! Keine Aenderung ohne Zustimmung der federfuehrenden Konstruktion / Any alterations are subject to the approval of the design department</small></p> <p>Technical Component Requirement Specifications Tail lamp QEV 111 AJPNLG</p>	<p>Bearb./auth.: Hans Peter Schiffert Abt./dep.: RD/KEL Datum/date: 2022-07-25 Requirement Specifications 001 version: Seite/page: 97 of 220</p>
---	--	--

permitted. The verification is realized via a visual inspection as well as a leak test

2.1.15.6.7 Condensed Water Test for Metallized Components (4057037)

- 4072684 *Purpose:*
- 4072688 *The test is to ensure the resistance of the metallized integral parts of the component to condensed water.*
- 4072686 *Test:*
- 4072687 The test is performed based on DIN EN ISO 6270 on a signal lamp without cover plate (i.e. with exposed, vapor-deposited or sputtered interior parts).
- 4072689 *The test can alternatively be carried out on the single part.*
- 4072690 The DUT shall be stored for 48 h at 40 °C and 98% relative humidity. The position shall be selected so that the largest possible vapor-deposited/sputtered surface to be tested is accordingly exposed to condensed water.
- 4072693 *Requirement:*
- 4072694 The DUT shall not exhibit any visual changes during and after the test. The verification is realized via a visual inspection.

2.1.16 Sample and Delivery Dates (STLH-rm3-2785790)

STLH-rm3-2785788
FI-PI-282 The corresponding deadlines shall be taken from the MDS plan/PMP for suppliers and the provided "Overview of Product Maturity Level Stages of Component".

2.1.16.1 Digital Warm Sample (STLH-rm3-2832920)

- STLH-rm3-2832941
FI MH-3440 The supplier shall create renderings of the lamp over the course of the development process in order to validate the engineering design and lighting systems.
- STLH-rm3_3961700 The digital warm samples are a central tool for the series production development of lamps. The expenditure for deriving the digital warm samples from the respective design status as well as the design of the light functions for this purpose shall be taken into account in the series production development costs and be reported separately.
- STLH-rm3_3961397 What is known as a digital warm sample shall be created once on the basis of the DE-Freeze ABEL data and another time on the basis of the VDMF ABEL data.
- STLH-rm3_3961697 The first provision of the digital warm samples shall take place 6 weeks each after DE-Freeze ABEL and VDMF ABEL.
In addition, the contractor shall take into account a two-time revision of the digital warm samples. Their provision dates are 10 weeks or 12 weeks after DE-Freeze ABEL and VDMF ABEL.
- STLH-rm3-2785811
FI-PI-778 The warm samples are used for the evaluation and approval of the engineering design / design for standard production of all the component parts visible when the component is viewed in the illuminated (warm) and non-illuminated (cold) status. In

Mercedes-Benz - Confidential -	Schutzvermerk DIN ISO 16016 beachten! /Refer to protection notice DIN ISO 16016! Keine Aenderung ohne Zustimmung der federfuehrenden Konstruktion / Any alterations are subject to the approval of the design department	Bearb./auth.: Hans Peter Schiffert Abt./dep.: RD/KEL Datum/date: 2022-07-25 Requirement Specifications 001 version: Seite/page: 98 of 220
	Technical Component Requirement Specifications Tail lamp QEV 111 AJPNLG	

the digital warm samples, the contractor shall implement the full scope of the engineering design /design for standard production for all directly and indirectly (due to reflections or joints) visible component parts.

STLH-rm3-2832933 The supplier shall ensure that the results of the digital warm sample are available in a quality that facilitates an evaluation of the light functions.

STLH-rm3-2832939 The supplier shall disclose the expected weak points of the lamp (e.g. non-homogeneous illumination, undesired reflections, mirrorings, etc.) by means of the digital warm sample.

STLH-rm3-2832927
FI MH-3441 *The rendering requirements are defined in the following.*

2.1.16.1.1 Software (STLH-rm3-2832945)

STLH-rm3-2832951
FI MH-3436 The software used by the supplier for the technical renderings shall comply with the CIE 171:2006 standard.

STLH-rm3-2832929
FI MH-3437 The software used shall calculate all active light functions in accordance with the Monte Carlo algorithm.

STLH-rm3-2832911
FI MH-3442 Ray tracing is the only calculation method permitted for global illumination. Ambient occlusion, photon mapping, and other physically incorrect methods shall not be used.

STLH-rm3-2832928
FI MH-3443 The supplier shall communicate the rendering software used to Mercedes-Benz AG.

STLH-rm3-2832944
FI MH-3444 The contractor shall disclose the rendering calculation method to Mercedes-Benz AG (tracing process used, algorithm, applied approximations, simulation parameters used)

2.1.16.1.2 CAD Data (STLH-rm3-2832910)

STLH-rm3-2832936
FI MH-3446 For warm sample renderings, the contractor shall use the data status that is envisaged for the tool release.

STLH-rm3-2832934
FI MH-3447 The CAD data record used shall be provided to Daimler AG including a complete description of all effective photometric materials used and their surfaces.

STLH-rm3-2832930
FI MH-3448 Mercedes-Benz AG will indicate in good time before the start of the preparation for rendering whether the left or right side of the lamp unit/tail lamp shall be rendered.

STLH-rm3-2832915
FI MH-3449 Wiring harnesses, plug pins, and the fastening concept do not need to be rendered if they are not located in the field of vision of the installed lamp and no photometric effects are expected.

STLH-rm3-2832908
FI MH-3450 The supplier shall also render the direct environment of the lamp unit/tail lamp (spline data curve, chrome trims, etc.).

2.1.16.1.3 Material Documentation and Material Definition (STLH-rm3-2832917)

STLH-rm3-2832953 All parts of the object to be rendered shall be documented with the optical properties

Mercedes-Benz - Confidential -	Schutzvermerk DIN ISO 16016 beachten! /Refer to protection notice DIN ISO 16016! Keine Aenderung ohne Zustimmung der federfuehrenden Konstruktion / Any alterations are subject to the approval of the design department	Bearb./auth.: Hans Peter Schiffert Abt./dep.: RD/KEL Datum/date: 2022-07-25 Requirement Specifications 001 version: Seite/page: 99 of 220
	Technical Component Requirement Specifications Tail lamp QEV 111 AJPNLG	

FI MH-3452	of the materials actually used.
STLH-rm3-2832914 FI MH-3453	Material properties may only be determined via the direct conversion of a measurement into the format of the software used. If the software used does not offer this option, it shall be ensured that the material properties are defined via the accurate simulation of measured optical properties. The responsibility for the material properties used rests with the supplier.
STLH-rm3-2832954 FI MH-3455	During the definition of optical material properties, all laws relating to geometrical beam optics shall be taken into account.
STLH-rm3-2832916 FI MH-3454	Surface roughnesses shall be defined in accordance with the VDI standard or via the goniometrically measured scattering properties of a material.
STLH-rm3-2832913 FI MH-3456	Photometrically effective surfaces, e.g. of reflectors, shall also be simulated with the roughness expected from the tool in addition to simulations regarding their reflectance.

2.1.16.1.4 Light Sources (STLH-rm3-2832921)

STLH-rm3-2832952 FI MH-3458	Three of the *.HDR files specified by Mercedes-Benz AG shall be used as the ambient illumination. These are provided and defined by Mercedes-Benz AG at the start of the simulation activities.
STLH-rm3-2832906 FI MH-3459	It shall as a result be possible to subsequently change the luminance of the ambient illumination.
STLH-rm3-2832947 FI MH-3460	All active light functions of the lamp unit/tail lamp shall be simulated.
STLH-rm3-2832937 FI MH-3461	All light sources shall either be simulated with ray files of the corresponding light source type or the light sources shall be calculated as surface sources that simulate the emission characteristics of the illuminant described in the data sheet. In all cases, the spectrum provided by the light source manufacturer shall be used.
STLH-rm3-2832949 FI MH-3462	All light sources shall be simulated with a light flux of 1 lumen. If the rendering software used does not permit a subsequent change/scaling of the light flux in the result, the light flux values for the rendering shall be selected by the supplier so that the light function in the result display is not wiped out. It shall nevertheless be set brightly enough to detect, where appl., reflections, etc. Mercedes-Benz AG reserves the right in this case to request that the rendering be performed again with adjusted light fluxes.

2.1.16.1.5 Sensors (STLH-rm3-2832946)

STLH-rm3-2832938 FI MH-3464	Each sensor shall render an image with a pixel resolution of 3840x2160 pixels.
STLH-rm3-2832932 FI MH-3465	The distance between the sensors and the object to be rendered shall be selected so that the resulting image can be shown in full screen mode with a scale of 1:1 with the real geometric object size on a 65" monitor with a resolution of 3840x2160 pixels.
STLH-rm3-2832924 FI MH-3466	The sensors shall be positioned at the angles shown in Figure 1 for a left lamp unit/tail

Mercedes-Benz - Confidential -	Schutzvermerk DIN ISO 16016 beachten! /Refer to protection notice DIN ISO 16016! Keine Aenderung ohne Zustimmung der federfuehrenden Konstruktion / Any alterations are subject to the approval of the design department	Bearb./auth.: Hans Peter Schiffert Abt./dep.: RD/KEL Datum/date: 2022-07-25 Requirement Specifications 001 version: Seite/page: 100 of 220
	Technical Component Requirement Specifications Tail lamp QEV 111 AJPNLG	

lamp. For a right light unit / taillight, the angles shall be accordingly mirrored on the vertical.

The supplier shall simulate additional angles to the positions shown in Fig. 1, if it expects weak points of the lamp under other angles.

STLH-rm3-2832931

Abbildung 1	90L	45L	20L	H0	20R
25U				X	
15U		X			X
V0				X	

STLH-rm3-2832907
FI MH-3467

Every sensor shall have a resolution of ≤ 0.041 p/mm

STLH-rm3-2832948
FI MH-3468

The integration angle of the sensors shall be $\leq 3^\circ$

2.1.16.1.6

Simulation Parameters (STLH-rm3-2832925)

STLH-rm3-2832918
FI MH-3471

The simulation duration (number of beams used, etc.) shall be selected by the supplier so that no improvement in the result is discernible with a longer simulation duration.

STLH-rm3-2832905
FI MH-3472

The number of beam interactions shall be selected so that a max. beam stop rate of 1% occurs for all lighting systems of the lamp unit/tail lamp

STLH-rm3-2832942
FI MH-3473

The meshing of the objects shall be selected to be so small that no artifacts are recognizable in the resulting image.

2.1.16.1.7

Results (STLH-rm3-2832923)

STLH-rm3-2832909
FI MH-3475

The supplier shall deliver the results in an uncompressed image format such as *.TIFF or as an uncompressed *.jpeg or *.png.

STLH-rm3-2832904
FI MH-3476

An image output with HDR shall correspond to the format HDR10 or HDR10+.

STLH-rm3-2832926
FI MH-3477

Mercedes-Benz AG reserves the right to request the rendering results in the native file format of the rendering software used.

STLH-rm3-2832950
FI MH-3478

From each rendered sensor, an image with all calculated ambient illuminations shall be delivered. An image per active light function shall also be delivered for each sensor.

STLH-rm3-2832940
FI MH-3479

A result for each individually activated light function shall be delivered from every perspective.

Mercedes-Benz - Confidential -	<small>Schutzvermerk DIN ISO 16016 beachten! /Refer to protection notice DIN ISO 16016! Keine Aenderung ohne Zustimmung der federfuehrenden Konstruktion / Any alterations are subject to the approval of the design department</small>	Bearb./auth.: Hans Peter Schiffert Abt./dep.: RD/KEL Datum/date: 2022-07-25 Requirement Specifications 001 version: Seite/page: 101 of 220
	Technical Component Requirement Specifications Tail lamp QEV 111 AJPNLG	

STLH-rm3-2832935
FI MH-3480

The shown light flux of the active light functions in the resulting images shall be jointly determined with Mercedes-Benz AG.

STLH-rm3-2832943
FI MH-3481

Active light functions shall be shown with a glare effect in accordance with VOS 1984. The intensity of this effect shall be agreed on with Mercedes-Benz AG.

STLH-rm3-2832919
FI MH-3482

The resulting images shall be created with a human vision simulation. The simulated adaptation luminous density of the human eye shall not be dynamically calculated. The adaptation parameters shall be jointly determined with Mercedes-Benz AG.

2.1.16.2

Specific Exterior Lighting Hardware Development Samples (STLH-rm3-2785789)

STLH-rm3-2785791
FI-PI-685

The sample statuses described in the following are envisaged in the development process of the exterior lighting components. These samples are created by the contractor and will be separately ordered by the client.

STLH-rm3-2785818
FI-PI-686

The contractor shall take into account the development activities for the derivation of samples from the series-production design as well as the coordination activities for the sample development, creation, and presentation in the supplier development costs of the component and report this separately.

STLH-rm3-2785795
FI-PI-699

The development samples for the exterior lighting are used to validate and confirm the envisaged concepts or the design for standard production as well as the function development. The samples shall facilitate an evaluation and confirmation of the subsequent execution in the series-production parts for the illuminated (warm) and non-illuminated (cold) status or for the light distribution and the light functions.

2.1.16.2.1

Partial Range Samples (STLH-rm3_3924482)

STLH-rm3_3961692

Partial range samples are created based on an interim status of the component design data to be determined. The contractor shall prepare the data from a functional aspect for photometric design and sample creation.

STLH-rm3_3961693

The delivery of the partial range sample(s) shall take place 2 weeks before DE-Freeze ABEL.

STLH-rm3-2785797
FI-PI-697

In the sub-area sample, the light functions that are visible when looking at the component shall be implemented for the illuminated state (warm state). Visible light functions can be: Signaling lights, floor lighting, illuminated lettering, module light stagings, lenses and lens expansions for the exterior lighting functions, illuminated trim lines, or similar.

2.1.16.2.2

Warm Samples for DE-Freeze ABEL (STLH-rm3_3924539)

STLH-rm3-2785799
FI-PI-775

The contractor shall create the "warm sample for DE-Freeze ABEL" based on the approved design freeze ABEL data.

STLH-rm3-2785801
FI-PI-772

The "warm samples for DE-Freeze ABEL" are used to evaluate the series-production

Mercedes-Benz - Confidential -	<small>Schutzvermerk DIN ISO 16016 beachten! /Refer to protection notice DIN ISO 16016! Keine Aenderung ohne Zustimmung der federfuehrenden Konstruktion / Any alterations are subject to the approval of the design department</small> Technical Component Requirement Specifications Tail lamp QEV 111 AJPNLG	Bearb./auth.: Hans Peter Schiffert Abt./dep.: RD/KEL Datum/date: 2022-07-25 Requirement Specifications 001 version: Seite/page: 102 of 220

design of all the component parts visible when the component is viewed in the illuminated (warm) and non-illuminated (cold) state. In the "warm sample for DE-Freeze ABEL", the contractor shall implement the full scope of the series-production design for all directly and indirectly (due to reflections or joints) visible component parts in a high-quality sample version.

STLH-rm3-2785807
FI-PI-773

The "warm samples for DE-Freeze ABEL" are used to assess the component with regard to undesired reflex reflections, hot spots, inhomogeneities, diffused light, visibility through joints and gaps, and reflections in the warm and cold state.

STLH-rm3_3961694

Delivery of the "warm sample(s) for DE-Freeze ABEL" shall take place at the latest 12 weeks after DE-Freeze ABEL.

STLH-rm3-2785805
FI-PI-776

The contractor shall produce the findings gained by means of the "warm sample for DE-Freeze ABEL" in the further course of the series-production design.

2.1.16.2.3

VDMF Warm Sample (STLH-rm3_3924605)

STLH-rm3-2785809
FI-PI-704

The "VDMF warm sample" serves for the evaluation and approval of the series-production design of all the component parts visible when the component is viewed in the illuminated (warm) and non-illuminated (cold) status. In the "VDMF warm sample", the contractor shall realize the full scope of the series-production design for all directly and indirectly (due to reflections or joints) visible components in a high-quality sample version.

STLH-rm3_3961696

The "VDMF warm sample(s)" shall be delivered at the latest 12 weeks after VDMF ABEL

2.1.17

Tool Concept and Controlling (STLH-rm3-2785822)

STLH-rm3-2785821
FI-PI-284

The contractor shall agree upon the tool concepts with the client in good time before the planning specification.

STLH-rm3-2785819
FI-PI-285

The contractor shall specify the tool supplier as well as the tool creation and tracking (tool controlling) in coordination with the client.

STLH-rm3-2785820
FI-PI-754

Tooling concepts and the region of origin of the tools will be agreed on, evaluated, and finally negotiated by the blank release between the client's Tool Cost Planning and the supplier.

STLH-rm3-2785826
FI-PI-286

The contractor shall maintain corresponding schedules for all tools and submit these to the client at regular intervals and/or in the case of changes.

STLH-rm3-2785824
FI-PI-287

Tools shall be designed in such a way that changes are possible at low cost. Examples: Layout of fastening points, introduction of radii, additional ribbing or stiffening measures, corrugation, etc.

STLH-rm3-2785827
FI-PI-755

The tooling shall be designed for maximum consistency during series production! The tooling concepts shall be agreed on by the blank release with the client's Tool Cost Planning.

Mercedes-Benz - Confidential -	<small>Schutzvermerk DIN ISO 16016 beachten! / Refer to protection notice DIN ISO 16016! Keine Aenderung ohne Zustimmung der federfuehrenden Konstruktion / Any alterations are subject to the approval of the design department</small>	Bearb./auth.: Hans Peter Schiffert Abt./dep.: RD/KEL Datum/date: 2022-07-25 Requirement Specifications version: 001 Seite/page: 103 of 220
	Technical Component Requirement Specifications Tail lamp QEV 111 AJPNLG	

STLH-rm3-2785823 FI-PI-640	All functional surfaces shall be rounded relative to each other using radii (prevention of notch effect). Functional surfaces include all surfaces of the housing to the exclusion of the design surfaces.
STLH-rm3-2785825 FI-PI-641	Possible deforming differences between the housing and installation parts shall be taken into account during the tool design (e.g. screw-on domes and sealing ribs).
STLH-rm3-2785832 FI-PI-642	Different legal certification markings shall be provided (in tools and machinery and equipment) for ECE, SAE, CCC and shall be an integral part of the basic offer (laser system and/or exchangeable insert in the tool).
STLH-rm3-2785829 FI-PI-786	Unless otherwise specified (e.g. in the RFQ drawing, data control model, or in the light sample acceptance), the surface structures shall only be incorporated in the tools after the joint appraisal of the parts by the contractor and client after the "off-tool parts" milestone. Photometrically effective surface structures are exempt; to ensure the light values, these shall already be incorporated in off-tool parts.
STLH-rm3-2785828 FI-PI-664	As the grained areas have not yet been finally specified at the point in time of contract award, the contractor shall provide a possible grain with a min. grain depth in accordance with [VDI 3400] reference 33 for all visible surfaces on the finished vehicle in the technical and commercial offer.
STLH-rm3-2785831 FI-PI-734	The contractor shall ensure that self-adhesive component parts on the tail lamp are not bonded over component part/tool divisions.
STLH-rm3-2785833 FI-PI-751	Housings with mounts, bolt domes, functional ribs, etc. shall, if necessary, only be shown in schematic diagram form and possibly not in the demolding direction. The contractor shall provide mold-specific functions and/or gate valves and report these as an integral part of the basic offer.
STLH-rm3-2785837 FI-PI-752	The main molds for the lighting system (housing, reflector, lens) as well as associated secondary molds shall be provided with a shot counter during creation before use in production (e.g. Hasco, Strack, Männer).

2.1.18 General Requirements Pertaining to Injection-Molded Plastic Parts and Their Value Appeal (STLH-rm3-2785834)

STLH-rm3-2785835 FI-PI-644	The contractor shall design and produce all visible component parts of the lamp so that no value appeal-reducing characteristics are visible in the installed status.
STLH-rm3-2785836 FI-PI-645	Value appeal-reducing characteristics include: Engagements, attachments, bolt domes, adhesive or welding beads, mounting brackets, imprecise template edges in the case of partial vapor depositions, flow hooks, flow lines, gate marks, slide mold lines, sloppy surface transitions, scratches, and marks. The list is not exhaustive. The contractor shall for this purpose also take into account its own aspirations regarding the high quality of its products.
STLH-rm3-2785838 FI-PI-647	For all visible plastic parts, the contractor shall perform mold flow tests and agree on the resulting position of weld lines, flow lines, or similar with the client. In this connection, the contractor shall, as a rule, take into account that an alternative design

Mercedes-Benz - Confidential -	<small>Schutzvermerk DIN ISO 16016 beachten! /Refer to protection notice DIN ISO 16016! Keine Aenderung ohne Zustimmung der federfuehrenden Konstruktion / Any alterations are subject to the approval of the design department</small> Technical Component Requirement Specifications Tail lamp QEV 111 AJPNLG	Bearb./auth.: Hans Peter Schiffert Abt./dep.: RD/KEL Datum/date: 2022-07-25 Requirement Specifications 001 version: Seite/page: 104 of 220
---	---	---

needs to be found for the injection-molded part if approval is not granted.

STLH-rm3-2785842
FI-PI-648

Over the course of development, the contractor shall disclose all value appeal-reducing characteristics that arise in its opinion due to the visible component part design specified by the client and cannot be prevented; however, at the latest in concept review 2 and have these confirmed by the client. The contractor shall document these characteristics in the release drawing.

STLH-rm3-2785841
FI-PI-649

The qualitative evaluation of the visible component parts of the component shall be performed in accordance with [MBN 10503].

STLH-rm3-2785839
FI-PI-650

If fluctuations arise due to the production process that can result in value appeal-reducing characteristics, the contractor shall agree for this purpose with the client on the permissible process window based on reference samples.

STLH-rm3-2785840
FI-PI-651

Production processes that result due to process fluctuations in increased rejects due to decorative defects may only be used by the contractor with the approval of the client. For the approval of such a process, the contractor shall also initiate the specification of reference samples and subsequently provide the required proofs for the production of the required unit figures within the specified process window.

STLH-rm3-2785847
FI-PI-753

If visible surfaces are only partially metalized, the template technology shall be designed so that a precise separation between the metalized and non-metalized areas is realized. The step or groove required for this purpose shall be designed to be ≤ 1.0 mm. The contractor shall present the planned implementation to the client at the latest by concept review 2. The contractor shall, as a rule, initiate the specification of reference samples for all partial metalizations.

STLH-rm3-2785844
FI-PI-660

The metalization or partial metalization of transparent parts shall be designed so that no emerging light can be perceived through the metalized surface. The contractor shall present all the geometric or process-related measures required for this purpose to the client at the latest by concept review 2.

STLH-rm3-2785843
FI-PI-654

The contractor shall provide trim lines or "clio lines" in the lenses and these shall be part of the basic offer.

STLH-rm3-2785846
FI-PI-655

The contractor shall provide design optics, microstructures, laser structures (trim lines can also be set against the demolding direction) for "glass bodies"/thick-wall optics/intermediate lenses. These shall be an integral part of the basic offer.

STLH-rm3-2785852
FI-PI-656

"Glass bodies"/thick-wall optics/intermediate lenses shall be shown in schematic diagram form in the RFQ documents.

STLH-rm3-2785848
FI-PI-657

Separation lines due to exchangeable inserts in areas visible from the outside shall be designed so that they are no longer visible in the finished vehicle at a distance of >1 m.

STLH-rm3-2785851
FI-PI-792

The course of the separation line shall be agreed on with the MBAG person responsible in the development phase for concept review 2 and documented.

STLH-rm3-2785849
FI-PI-658

All visible component part edges, delimitations, trimming edges, surface runouts and transitions shall be designed to be precise and burr-free. Trimming edges shall not be located in visible areas.

<p>Mercedes-Benz - Confidential -</p>	<p><small>Schutzvermerk DIN ISO 16016 beachten! / Refer to protection notice DIN ISO 16016! Keine Aenderung ohne Zustimmung der federfuehrenden Konstruktion / Any alterations are subject to the approval of the design department</small></p> <p>Technical Component Requirement Specifications Tail lamp QEV 111 AJPNLG</p>	<p>Bearb./auth.: Hans Peter Schiffert Abt./dep.: RD/KEL Datum/date: 2022-07-25 Requirement Specifications 001 version: Seite/page: 105 of 220</p>
---	---	---

STLH-rm3-2785850 FI-PI-663	All visible areas shall be incorporated into the tool in a categorized manner (technical polish, gloss polish, high-gloss polish). The client will define visible areas that deviate from these (e.g. due to grains for decorative purposes) in the interior design surface specification.
STLH-rm3-2785855 FI-PI-661	The component shall be designed so that no ingress of splash water or operating fluids is possible.
STLH-rm3-2785854 FI-PI-662	All external component parts of the component shall be designed so that fluids (e.g. splash water) can drain out in the installed position. For this purpose, the contractor shall take into account drain holes or corresponding geometric solutions.
STLH-rm3-2785853 FI-PI-652	Mold-flow analyses shall also be applied for weight optimization by reducing the wall thickness in addition to the validation of the production feasibility. These are to be presented to the client as part of concept review 2.
STLH-rm3-2785857 FI-PI-653	All tools for design-relevant component parts as well as photometric-relevant component parts are subject to the retention of title of the client. The creation is processed via the TTS process. Accordingly required tools shall be individually examined and taken into account per derivative.

2.1.19 Requirements as part of Offer Creation, Contract Award, and Change Management (STLH-rm3-2785856)

STLH-rm3-2785858 FI-PI-666	As the basis for offer creation, the contractor shall take into account the supplementary technical documents provided by the client that describe the components.
STLH-rm3-2785859 FI-PI-667	The supplementary technical documents provided for order creation are:
STLH-rm3-2785862 FI-PI-668	- BOMs on single part and/or assembly level for all component variants
STLH-rm3-2785860 FI-PI-669	- 3D data with illustrations of the design of the component and, if applicable, relevant installation space restrictions
STLH-rm3-2785861 FI-PI-713	<i>The provided 3D data shows a design state that is still in the technical validation phase (model confirmation) and can therefore be considered only as orientation in the context of determining component part sizes.</i>
STLH-rm3-2785867 FI-PI-670	- 2D drawings
STLH-rm3-2785863 FI-PI-671	- Descriptions of surfaces of visible component parts
STLH-rm3-2785865 FI-PI-672	- Deviating descriptions in the event of parameterized contract award of multiple projects based on a single component requirement specifications document and/or a single BOM
STLH-rm3-3005018	The provided representations (2D or 3D) of the design parts usually do not yet contain the wall thicknesses and also no geometries for the attachment of the component parts. The contractor shall take into account the required geometries for the implementation of a subsequent attachment in the offer creation.

Mercedes-Benz - Confidential -	Schutzvermerk DIN ISO 16016 beachten! / Refer to protection notice DIN ISO 16016! Keine Aenderung ohne Zustimmung der federfuehrenden Konstruktion / Any alterations are subject to the approval of the design department	Bearb./auth.: Hans Peter Schiffert Abt./dep.: RD/KEL Datum/date: 2022-07-25 Requirement Specifications 001 version: Seite/page: 106 of 220
	Technical Component Requirement Specifications Tail lamp QEV 111 AJPNLG	

STLH-rm3-2785864
FI-PI-673

If not all the component description information for offer creation is available from the contractor's perspective, the contractor shall request this information in written and aggregated form from the client. Questions shall be submitted one week before the first offer meeting. Any arising questions shall be subsequently submitted also in aggregated form at the latest one week after the offer presentation.

STLH-rm3-2785866
FI-PI-674

The contractor shall indicate the quantity, manufacturer and type of envisaged LEDs in the offer and/or the PBDs.

STLH-rm3-2785868
FI-PI-675

The designations specified by the client in the RFQ BOM shall be used in the PBDs, offer presentations, and other documents.

STLH-rm3-2833076

The contractor shall indicate all changes to the component in comparison to the status shown in the PBD to the client before the change is implemented and agree on this with the client. This also applies for assemblies and parts of the component that lie in its design responsibility.

STLH-rm3-2785869
FI-PI-730

The contractor shall, upon request, provide the client with photometric simulation data for the technical system and concept evaluation

2.1.20 General (4266009)

2.1.20.1 Introduction (4266012)

4266011
SB-14

This document describes a system for all components.

4266010
SB-18

The system requirement specifications contain all mandatory requirements on the development of a vehicle system.

4266013
SB-1047

Starting from the requirements on the overall vehicle level, the system requirement specifications describe all requirements on a system of the vehicle in a structured way, gradually refines these descriptions and passes them on in consolidated form to the corresponding component requirement specifications. The system requirement specifications form the link between the concept or vehicle requirement specifications and the component requirement specifications.

4266014
SB-19

The mandatory specification of the components involved in the system occurs through component requirement specifications and the other applicable documents referred to there.

2.1.20.2 Short Description of the System (4266015)

4266016
SB-992

The Exterior Lights system description describes all light functions that lead to the exterior lighting being switched on and off.

4266017
PV_ELC-3122

Diagram for the system:

Mercedes-Benz - Confidential -	<small>Schutzvermerk DIN ISO 16016 beachten! /Refer to protection notice DIN ISO 16016! Keine Aenderung ohne Zustimmung der federfuehrenden Konstruktion / Any alterations are subject to the approval of the design department</small>	Bearb./auth.: Hans Peter Schiffert Abt./dep.: RD/KEL Datum/date: 2022-07-25 Requirement Specifications 001 version: Seite/page: 107 of 220
	Technical Component Requirement Specifications Tail lamp QEV 111 AJPNLG	

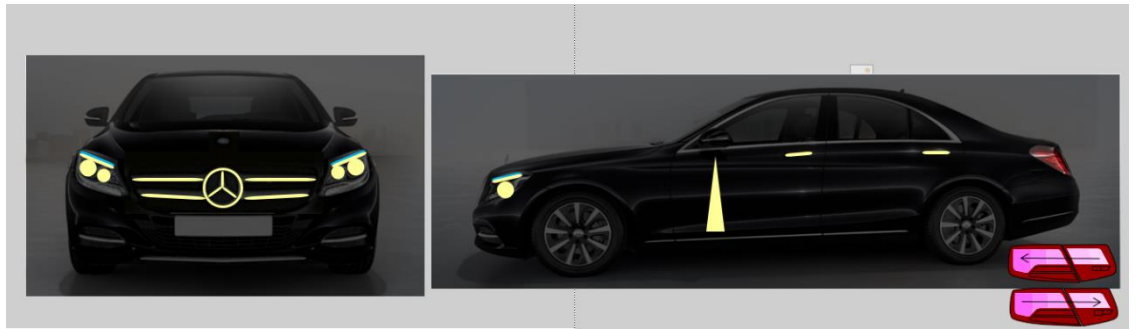

2.1.20.3 System Limits (4266018)

4266020
PV_ELC-3401

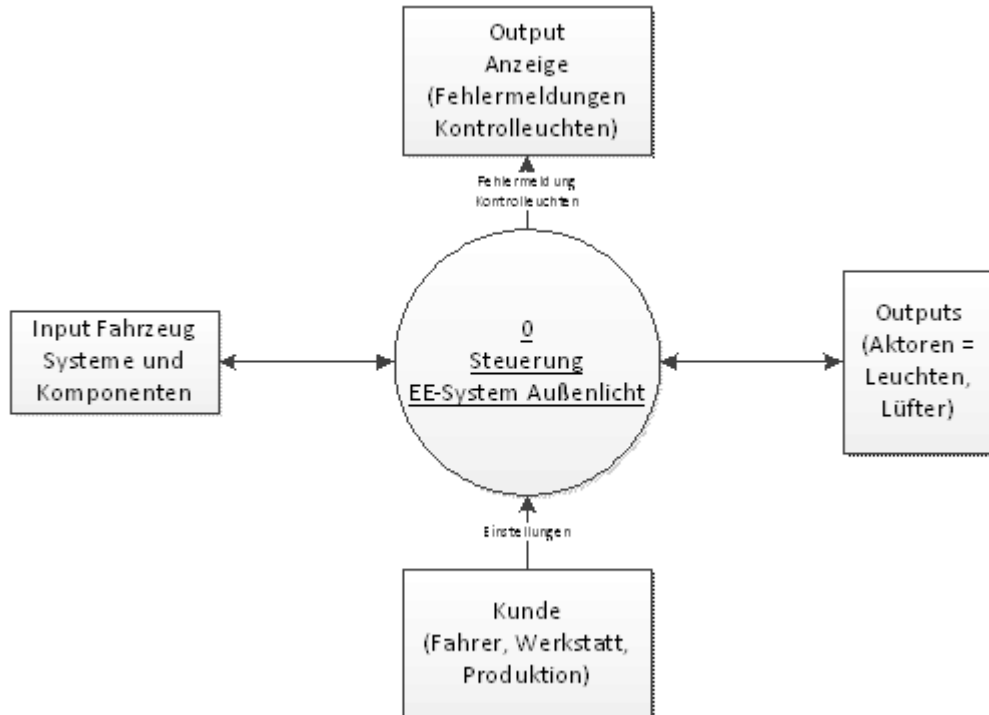

4266022
PV_ELC-22723

The representation of the system limits shows the adjacent content that the own system is in relation with.

In this context, the content either provides functionalities required by the own system and/or receives functionalities from the own system.

2.1.20.4 Assignment of the System to Vehicle or Engine Model Series (4266021)

4266019
SB-31

The system will be installed starting with the STAR3.5 architecture.

4266023
SB-924

The planned installation rate is: 100%.

<p>Mercedes-Benz - Confidential -</p>	<p><small>Schutzvermerk DIN ISO 16016 beachten! / Refer to protection notice DIN ISO 16016! Keine Aenderung ohne Zustimmung der federführenden Konstruktion / Any alterations are subject to the approval of the design department</small></p> <p>Technical Component Requirement Specifications Tail lamp QEV 111 AJPNLG</p>	<p>Bearb./auth.: Hans Peter Schiffert Abt./dep.: RD/KEL Datum/date: 2022-07-25 Requirement Specifications version: 001 Seite/page: 108 of 220</p>
---	--	--

2.1.20.5

Contacts (4266025)

4266026
SB-21

The following section lists the contacts for the system and the involved components.

2.1.20.5.1

Contacts for the Overall System (4266027)

4266024
SB-935

The current contacts for the system exterior lighting can be found in the RD system list.

2.1.20.5.2

Contacts for Adjacent Systems (4266028)

4266032
SB-1050

The neighboring systems listed make a contribution to the system. Responsibility for these systems lies with the department indicated. Questions concerning a system should be directed to the system manager. The contacts can be found in the RD system list.

2.1.20.5.3

Contacts for Components of the System (4266031)

4266030
SB-951

The components listed contribute to the system. They shall be overseen by the respectively designated department. In case of questions about a component, the component manager shall be contacted.

2.1.20.6

Change Management (4266029)

4266033
SB-956

If a change is made to the system, the person responsible for the system informs all affected departments about the change or involves them in the coordination process.

2.1.21

Requirements Pertaining to the System (4266037)

2.1.21.1

System Objectives (4266034)

4266036
PV_ELC-4944

As per legal requirements and optimal customer comfort, all exterior lights should be engaged.

2.1.21.2

Certification and Legal Constraints (4266035)

4266038
PV_ELC-201

All functions listed in the requirement specifications are certification-relevant. For this reason, the entire requirement specifications are designated as certification-relevant and no characteristics are listed below.

4266039
PV_ELC-4309

Documentation of the DZ characteristics: The DZ characteristics for the exterior lighting functions are documented in the drawings of the lamps (e.g. headlamps, rear lamps, etc.) and not further passed on in the vehicle, e.g. to the power supply or

Mercedes-Benz - Confidential -	<small>Schutzvermerk DIN ISO 16016 beachten! /Refer to protection notice DIN ISO 16016! Keine Aenderung ohne Zustimmung der federfuehrenden Konstruktion / Any alterations are subject to the approval of the design department</small>	Bearb./auth.: Hans Peter Schiffert
	Technical Component Requirement Specifications Tail lamp QEV 111 AJPNLG	Abt./dep.: RD/KEL Datum/date: 2022-07-25 Requirement Specifications 001 version: Seite/page: 109 of 220

control units.

2.1.21.2.1 DS-Relevant Functions in the Exterior Lighting System (4266041)

4266043
PV_ELC-462

DS1 = Standing lights: Ensuring the detectability of the vehicle for other road users ahead and behind in darkness.

4266040
PV_ELC-133

DS2 = Low beams: Ensuring adequate illumination of the road while driving in darkness.

4266042
PV_ELC-1656

DS4 = Brake lights: Ensuring a correct and timely indication of brake application for following traffic.

4266044
PV_ELC-5679

DS5 = Turn signaling: Ensuring the basic function of turn signals or fault display in the event of failure; ensuring a turn signal on the correct side; no unintended activation of the turn indicator.

4266047
PV_ELC-5652

DS6 = Hazard warning flashers: Ensuring the hazard warning function upon activation.

2.1.21.3 Functional Safety (4266046)

2.1.21.3.1 System Functions Taken into Account as Part of the Hazard Analysis and Risk Assessment (4266045)

4266048
SB-995

The customer-tangible functions from Chapter 2.6 have been assessed as part of HARA as per [ISO 26262]:

4266049
SB-1023

All other functions of the system were classified in the danger & risk analysis as not safety-relevant or QM.

2.1.21.3.2 Safety Objectives from the Hazard Analysis and Risk Assessment (4266050)

4266051
SB-1024

The following safety objectives are taken from the exterior lighting hazard analysis and risk assessment, revision 5.317:

4266052
SB-998

HARA ID: [SZ_1-1] Prevent failure of illumination of the road

4266053
PV_ELC-5639

When driving in the dark, a previously active low beam shall not fail for more than 1 s. Failure is: - Insufficient luminous power on both sides or - Headlamp ranges under 20 m on both sides or - Insufficient luminous power on one side and headlamp range under 20 m on the other side.

4266054
PV_ELC-305

Safe state: Low beams with sufficient luminous power and a headlamp range ≥ 20 m on at least one side.

4266057
PV_ELC-3085

HARA ID: [SZ_2-2] Prevent vehicle operation with defective front illumination on one side

Mercedes-Benz - Confidential -	<small>Schutzvermerk DIN ISO 16016 beachten! / Refer to protection notice DIN ISO 16016! Keine Aenderung ohne Zustimmung der federfuehrenden Konstruktion / Any alterations are subject to the approval of the design department</small>	Bearb./auth.: Hans Peter Schiffert
	Technical Component Requirement Specifications Tail lamp QEV 111 AJPNLG	Abt./dep.: RD/KEL Datum/date: 2022-07-25 Requirement Specifications 001 version: Seite/page: 110 of 220

4266056
PV_ELC-5653

Vehicle operation (several driving cycles) in the dark with (complete) failure of a headlamp shall be prevented

4266055
PV_ELC-3712

Safe state: For vehicle operation: Active lighting on both sides with at least perimeter light brightness

4266058
PV_ELC-5958

HARA ID: [SZ_3-1] Prevent failure of brake light

4266062
PV_ELC-1566

Brake application shall be indicated to following traffic correctly and in a timely manner

4266059
PV_ELC-3141

Safe state:

(1) Brake light is actuated if the vehicle decelerates;
not actuated if the vehicle does not decelerate.

(2) Provided state (1) cannot be achieved: Brake lights activated.
In addition: Fault display.

Note: A permanently activated brake light requires an additional reaction from the following traffic, as the actual deceleration is no longer signaled, but only that there is a problem with the brake light.

Therefore, as a general rule, the achievement of state (1) shall be striven for.

4266061
PV_ELC-5102

HARA ID: [SZ_3-2] Prevent failure of brake light actuation for trailers

4266060
PV_ELC-477

Brake application shall be provided at the interface correctly and in a timely manner

4266063
PV_ELC-2073

Safe state:

(1) Brake light is actuated if the vehicle decelerates;
is not actuated if the vehicle does not decelerate.

(2) Provided state (1) cannot be achieved: Brake lights activated.
In addition: Fault display.

Note: A permanently activated brake light requires an additional reaction by the following traffic, since what is being reported is no longer the actual deceleration but merely the fact that there is a problem with the brake light.

Therefore, as a general rule, the achievement of state (1) shall be striven for.

4266064
PV_ELC-3309

HARA ID: [SZ_4-1] Prevent failure of turn indicator

4266065
PV_ELC-22707

The turn indicator function shall be prevented from failing, and/or the driver shall be made aware of any failure that does occur

4266067
PV_ELC-2982

Safe state: Driver feedback on the turn indicator at double flasher frequency.

4266066
PV_ELC-4199

HARA ID: [SZ_4-2] Prevent unintended turn indicator activation (front)

Mercedes-Benz - Confidential -	<small>Schutzvermerk DIN ISO 16016 beachten! /Refer to protection notice DIN ISO 16016! Keine Aenderung ohne Zustimmung der federfuehrenden Konstruktion / Any alterations are subject to the approval of the design department</small>	Bearb./auth.: Hans Peter Schiffert Abt./dep.: RD/KEL Datum/date: 2022-07-25 Requirement Specifications 001 version: Seite/page: 111 of 220
	Technical Component Requirement Specifications Tail lamp QEV 111 AJPNLG	

4266068 PV_ELC-3042	Unintended activation of one or more turn indicators for longer than 660 ms shall be prevented
4266071 PV_ELC-3571	Safe state: No turn indicator, turn indicator deactivated or on both sides.
4266072 PV_ELC-1808	HARA ID: [SZ_4-3] Prevent turn indicator activation on the wrong side (general)
4266069 PV_ELC-3575	Turn indicator activation on the wrong side for longer than 660 ms shall be prevented
4266070 PV_ELC-3322	Safe state: No turn indicator, turn indicator deactivated or on both sides.
4266073 PV_ELC-3330	HARA ID: [SZ_4-4] Prevent turn indicator activation on the wrong side (trailer)
4266076 PV_ELC-16	Turn indicator activation on the wrong side for longer than 660 ms shall be prevented
4266077 PV_ELC-453	Safe state: No turn indicator, turn indicator deactivated or on both sides.

2.1.21.3.3 Safety Requirements (4266074)

4266075 SB-1001	<i>The respective safety requirements (including requirements for communication monitoring) from the functional safety concept for the exterior lighting are defined in the respective sections for the components and systems involved.</i>
4266078 PV_ELC-5800	<i>The safety objectives are linked to classification levels. The safety requirements from the functional safety concept are defined in these chapters. This means that the necessary traceability is achieved through the classification levels. These are also classified using the doors-chapter structure. This means that there is also no further linking of the safety requirements within the classification levels.</i>
4266080 SB-1100	All safety-relevant signals shall be protected in accordance with the following specifications:
4266081 SB-1101	- Specification of SW-C end-to-end communication protection library [AUTOSAR_SWS_E2ELibrary]
4266079 SB-1102	- End-to-end communication protection [QEV111AES5MSS]

2.1.21.4 Customer Functions (4266082)

4266083 PV_ELC-22478	Direction indication
4266085 PV_ELC-22803	<i>Turn signaling is the activation of the turn indicator by the customer using the turn signal lever or other systems (e.g. autonomous parking)</i>
4266087 PV_ELC-22804	<i>Turn signaling is a subfunction of the turn signal actuation system function</i>

Mercedes-Benz - Confidential -	<small>Schutzvermerk DIN ISO 16016 beachten! /Refer to protection notice DIN ISO 16016! Keine Aenderung ohne Zustimmung der federfuehrenden Konstruktion / Any alterations are subject to the approval of the design department</small> Technical Component Requirement Specifications Tail lamp QEV 111 AJPNLG	Bearb./auth.: Hans Peter Schiffert Abt./dep.: RD/KEL Datum/date: 2022-07-25 Requirement Specifications 001 version: Seite/page: 112 of 220

4266086 PV_ELC-22485	One-touch turn signaling
4266084 PV_ELC-22802	<i>One-touch turn signaling is the flasher extension to three flasher frequencies through brief actuation of the turn signal lever</i>
4266088 PV_ELC-22810	<i>One-touch turn signaling is a subfunction of the turn signal actuation system function</i>
4266092 PV_ELC-22489	Hazard warning flasher
4266091 PV_ELC-22805	<i>The hazard warning flasher can be activated by the customer or through other systems functions (e.g. anti-theft alarm, crash hazard warning flasher)</i>
4266093 PV_ELC-22798	<i>The hazard warning flasher is a subfunction of the turn signal actuation system function</i>
4266090 PV_ELC-22481	Environment staging
4266094 PV_ELC-22808	<i>With the environment staging, exterior lighting can be activated in order to illuminate the environment or generate specific lighting effects</i>
4266098 PV_ELC-22806	<i>Environment staging is a subfunction of the staging actuation system function</i>
4266099 PV_ELC-22491	Drive staging
4266097 PV_ELC-22811	<i>With drive staging, other lamps, such as the star and radiator grille lamps, can be actuated in addition to the indicator lights</i>
4266095 PV_ELC-22796	<i>Drive staging is a subfunction of the staging actuation system function</i>
4266096 PV_ELC-22488	Stop Lamp
4266102 PV_ELC-22797	<i>The brake lights are used to indicate brake application to the following traffic</i>
4266101 PV_ELC-22809	<i>Brake lights are a subfunction of the brake light actuation system function</i>
4266100 PV_ELC-22486	Manual high beams
4266103 PV_ELC-22800	<i>Manual high beams can be activated by the customer via the high beam switch and provide expanded vehicle illumination</i>
4266104 PV_ELC-22807	<i>Manual high beams are a subfunction of the high beam actuation system function</i>
4266107 PV_ELC-22482	Headlamp flashing (Lichthupe)
4266108 PV_ELC-22799	<i>Headlamp flashing is a brief activation of the high beams for communication</i>
4266106	<i>Headlamp flashing is a subfunction of the high beam actuation system function</i>

Mercedes-Benz - Confidential -	<small>Schutzvermerk DIN ISO 16016 beachten! /Refer to protection notice DIN ISO 16016! Keine Aenderung ohne Zustimmung der federfuehrenden Konstruktion / Any alterations are subject to the approval of the design department</small>	Technical Component Requirement Specifications Tail lamp QEV 111 AJPNLG	Bearb./auth.: Hans Peter Schiffert Abt./dep.: RD/KEL Datum/date: 2022-07-25 Requirement Specifications 001 version: Seite/page: 113 of 220

PV_ELC-22801

4266105
PV_ELC-22475

Automatic driving lights

4266109
PV_ELC-22815

Automatic driving lights provide the customer with the optimal light functions in accordance with ambient conditions

4266113
PV_ELC-22817

Automatic driving lights are a subfunction of the exterior lighting system function

4266110
PV_ELC-22479

Manual driving lights (MDL)

4266111
PV_ELC-22814

Manual driving lights enable the customer to always drive with low beams, regardless of environmental influences

4266112
PV_ELC-22813

Manual driving lights are a subfunction of the exterior lighting system function

4266114
PV_ELC-22476

Rear fog light

4266116
PV_ELC-22812

The rear fog light can be activated by the customer using a rear fog light pushbutton switch and helps to improve the visibility of the rear area

4266118
PV_ELC-22816

The rear fog light is a subfunction of the exterior lighting system function

4266117
PV_ELC-22484

Parking lights

4266115
PV_ELC-22822

Parking lights improve the visibility of a parked vehicle

4266119
PV_ELC-22818

Parking lights are a subfunction of the exterior lighting system function

4266121
PV_ELC-22490

Reversing light

4266123
PV_ELC-22823

The reversing light is used to indicate reverse travel

4266120
PV_ELC-22825

The reversing light is a subfunction of the reversing light control system function

4266122
PV_ELC-22480

Side lamp

4266124
PV_ELC-22829

Standing lights are used to improve the visibility of a vehicle that is not ready to drive

4266125
PV_ELC-22819

Standing lights are a subfunction of the exterior lighting system function

4266128
PV_ELC-22477

Bad weather light

4266127
PV_ELC-22826

The bad weather light improves the road illumination by activating the low beams

4266126
PV_ELC-22821

The bad weather light is a subfunction of the bad weather light actuation

<p>Mercedes-Benz - Confidential -</p>	<p><small>Schutzvermerk DIN ISO 16016 beachten! /Refer to protection notice DIN ISO 16016! Keine Aenderung ohne Zustimmung der federfuehrenden Konstruktion / Any alterations are subject to the approval of the design department</small></p> <p>Technical Component Requirement Specifications Tail lamp QEV 111 AJPNLG</p>	<p>Bearb./auth.: Hans Peter Schiffert Abt./dep.: RD/KEL Datum/date: 2022-07-25 Requirement Specifications 001 version: Seite/page: 114 of 220</p>
---	--	---

system function

4266129
PV_ELC-22487

Accident site lighting

4266133
PV_ELC-22828

Accident site lighting enables the customer to activate the beams even though the vehicle is not in driving mode

4266132
PV_ELC-22827

Accident site lighting is a subfunction of the accident site lighting actuation system function

4266130
PV_ELC-22483

Trailer illumination

4266131
PV_ELC-22824

Trailer lighting improves the illumination of a trailer and activates the tail light functions on the trailer

4266134
PV_ELC-22820

Trailer lighting is a subfunction of the exterior lighting system function

2.1.21.4.1 Basic Driving Functions (4266138)

2.1.21.4.1.1 Short Description (4266137)

4266136
PV_ELC-22135

The following functions are defined as basic driving functions in the exterior lighting system and shall be prioritized accordingly during development planning

4266135
PV_ELC-22127

- Turn signaling
- One-touch turn signaling
- Hazard warning flasher
- Brake lights
- High beams / Headlamp flashing
- Manual driving lights (MDL)
- Rear fog lamp
- Standing light
- Back-up light
- Parking lamp

2.1.21.4.1.2 Use Cases (4266139)

4266141
PV_ELC-22130

The basic functions can be activated by the customer via the controls

2.1.21.4.1.3 Functional Requirements (4266143)

4266140
PV_ELC-22143

The basic functions can be activated depending on the driving situation (e.g. ignition status, illumination status)

2.1.21.4.1.4 Functional Architecture (4266142)

4266144
PV_ELC-22126

Function chain for the basic function

Mercedes-Benz - Confidential -	<small>Schutzvermerk DIN ISO 16016 beachten! /Refer to protection notice DIN ISO 16016! Keine Aenderung ohne Zustimmung der federfuehrenden Konstruktion / Any alterations are subject to the approval of the design department</small>	Bearb./auth.: Hans Peter Schiffert
	Technical Component Requirement Specifications Tail lamp QEV 111 AJPNLG	Abt./dep.: RD/KEL Datum/date: 2022-07-25 Requirement Specifications 001 version: Seite/page: 115 of 220

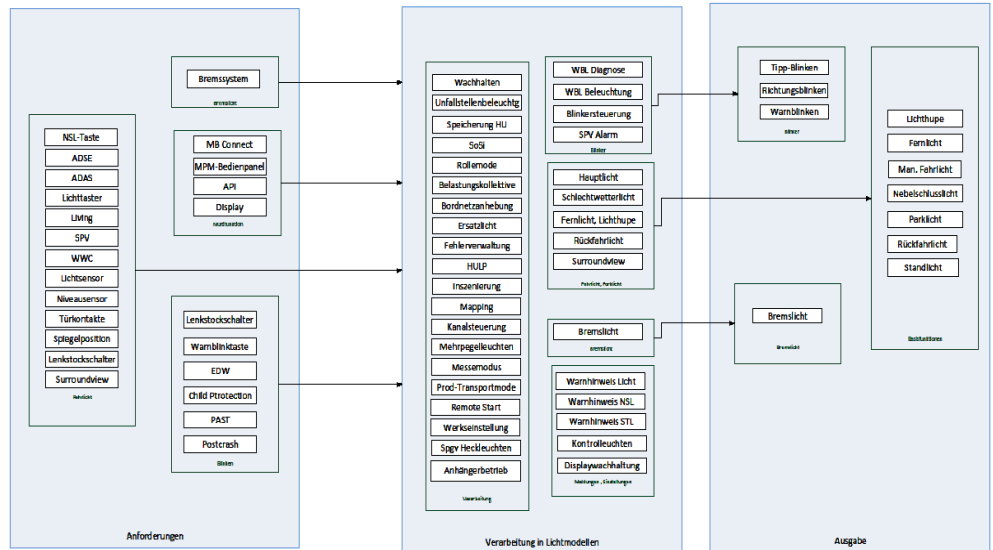

2.1.21.4.2 Extended Functions (4266145)

2.1.21.4.2.1 Short Description (4266148)

4266147
 PV_ELC-22193

The following functions are extended functions in the exterior lighting system and are offered in accordance with the optional equipment or the legal requirements

4266146
 PV_ELC-22187

- Environment animation
- Drive animation
- Automatic driving lights
- Bad weather light
- Accident site lighting
- Trailer lighting

2.1.21.4.2.2 Use Cases (4266149)

4266150
 PV_ELC-22184

The extended functions can be activated by the customer

2.1.21.4.2.3 Functional Requirements (4266153)

4266151
 PV_ELC-22191

The extended functions can be activated depending on the driving situation (e.g. ignition status, illumination status)

2.1.21.4.2.4 Functional Architecture (4266152)

4266154
 PV_ELC-22192

In accordance with the basic architecture

Mercedes-Benz - Confidential -	Schutzvermerk DIN ISO 16016 beachten! / Refer to protection notice DIN ISO 16016! Keine Aenderung ohne Zustimmung der federfuehrenden Konstruktion / Any alterations are subject to the approval of the design department	Bearb./auth.: Hans Peter Schiffert Abt./dep.: RD/KEL Datum/date: 2022-07-25 Requirement Specifications 001 version: Seite/page: 116 of 220
	Technical Component Requirement Specifications Tail lamp QEV 111 AJPNLG	

2.1.21.4.3 Service Provider System Function (API Interface) (4266157)

2.1.21.4.3.1 Short Description (4266155)

4266158
PV_ELC-22137

This function enables access to system functions via methods and the subscription of system values via events.

4266156
PV_ELC-22128

The following methods and events are available:

4266159
PV_ELC-22124

Method: RequestLights for the activation or the deactivation of parking lights or standing lights

4266160
PV_ELC-22141

Method: SetConfiguration for animation setting

4266161
PV_ELC-22147

Event: LampState for the output of the status of the lamps

4266164
PV_ELC-22149

Event: TrailerLampState for the output of the status of the trailer lamps

2.1.21.4.3.2 Use Cases (4266162)

4266163
PV_ELC-22138

The customer thus has the possibility to operate exterior lighting functions via online services

2.1.21.4.3.3 Functional Requirements (4266166)

4266165
PV_ELC-22129

Depending on the vehicle status (e.g. no engine running), light functions such as standing lights and parking lights can be activated

2.1.21.4.3.4 Functional Architecture (4266167)

4266168
PV_ELC-22133

Process chain for the API function

Mercedes-Benz - Confidential -	<small>Schutzvermerk DIN ISO 16016 beachten! / Refer to protection notice DIN ISO 16016! Keine Aenderung ohne Zustimmung der federfuehrenden Konstruktion / Any alterations are subject to the approval of the design department</small>	Bearb./auth.: Hans Peter Schiffert
	Technical Component Requirement Specifications Tail lamp QEV 111 AJPNLG	Abt./dep.: RD/KEL Datum/date: 2022-07-25 Requirement Specifications version: 001 Seite/page: 117 of 220

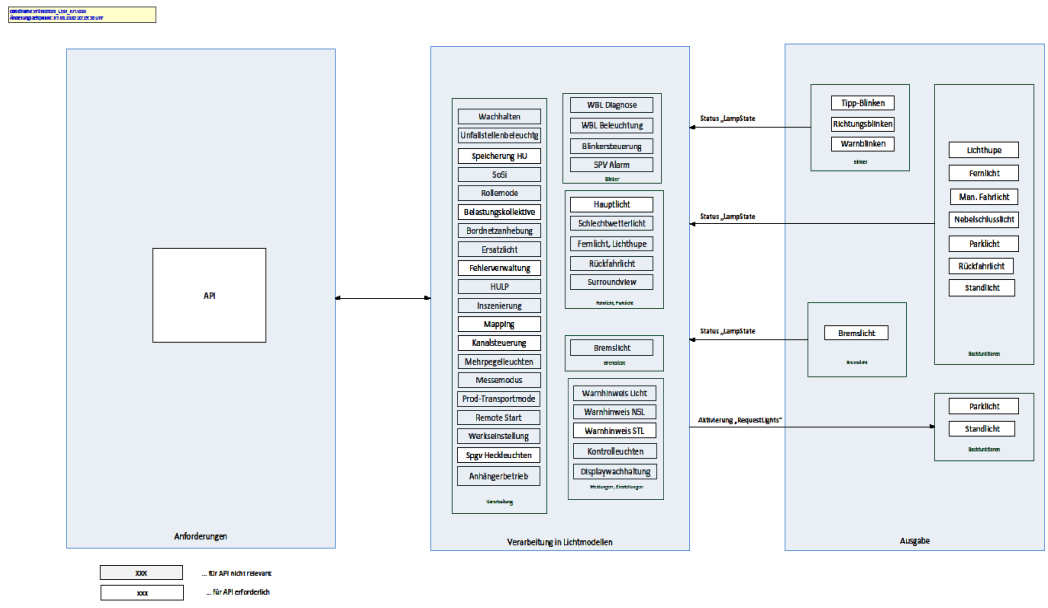

2.1.21.5 Function Description of System Functions (4266169)

2.1.21.5.1 ITC Short Description of the Software Functions (Calculation and Actuation) (4266170)

2.1.21.5.1.1 Overview (4266171)

4266172 PV_ELC-23570 *The Body Controller MMA (BC-MMA) contains the software components relevant for the ITC tail lamp actuation.*

2.1.21.5.1.2 LMRA Functions (4266174)

4266176 PV_ELC-23564 *The "LMRA" (Light Mapper Rear Advanced) software component is a model-based software element of BC-MMA that is the responsibility of RD.*

The LMRA generates the target brightnesses for all LEDs of the tail lamps from the function requirements of the exterior lighting master.

Depending on the ambient conditions, e.g. trunk lid open / turn indicator active / rear fog lamp active, the abstract function requirements are implemented in specific scenario requirements (scenario selection in the block diagram).

In the software, the brightnesses for 100 software LED channels with possible multiple functions (turn indicator / rear fog lamp / brake light / tail lamp) and 3 channels for the reversing light are calculated separately for the left and right (LTC algorithm in the

Mercedes-Benz - Confidential -	Schutzmerk DIN ISO 16016 beachten! /Refer to protection notice DIN ISO 16016! Keine Aenderung ohne Zustimmung der federfuehrenden Konstruktion / Any alterations are subject to the approval of the design department	Bearb./auth.: Hans Peter Schiffert Abt./dep.: RD/KEL Datum/date: 2022-07-25 Requirement Specifications 001 version: Seite/page: 118 of 220
	Technical Component Requirement Specifications Tail lamp QEV 111 AJPNLG	

block diagram).

The software LED channels represent the separately controllable channels in the software. In the LPSR (see below), these software LED channels can then be mapped to multiple physical hardware LED channels.

The brightness array is calculated for the turn indicator/rear fog lamp/brake light/tail lamp+animation functions. This calculation is carried out in parallel for every function scenario (turn indicator/rear fog lamp/brake light/tail lamp+animation).

If LED channels of multiple function scenarios are requested in this parallel calculation, the function for each LED channel is prioritized accordingly.

Prioritization sequence (in descending order)

Turn indicator

Rear fog lamp

Brake light

Taillight+animation

A request with the value 0% of a function with a higher priority will also be taken into account in the prioritization in order, for example, to implement rules on the spacing of the light functions. If, for example, an LED with 0% is explicitly requested for a rear fog lamp request while the brake light is active, a possibly active brake light will also be deactivated for this LED.

To define the fact that an LED channel is not relevant in a function scenario, the LED channel is coded with the value 102%.

In the case of the reversing light, the brightnesses are specified for 3 separate software LED channels. No prioritization occurs here as the LEDs in "white" can only be used for the reversing light function.

There are static and animated scenarios. Animated scenarios are only available for the tail lamp and turn indicator (e.g. dynamic turn indicator) functions.

Static scenarios (block diagrams) are configured via a data point diagram. For the animated scenarios, the different data point diagrams (max. 30) are combined with a time frame (parameterizable time steps between the data point diagrams). The data point pool contains all data point diagrams for static and animated scenarios and all functions.

Mercedes-Benz - Confidential -	<small>Schutzvermerk DIN ISO 16016 beachten! /Refer to protection notice DIN ISO 16016! Keine Aenderung ohne Zustimmung der federfuehrenden Konstruktion / Any alterations are subject to the approval of the design department</small> Technical Component Requirement Specifications Tail lamp QEV 111 AJPNLG	Bearb./auth.: Hans Peter Schiffert Abt./dep.: RD/KEL Datum/date: 2022-07-25 Requirement Specifications 001 version: Seite/page: 119 of 220
---	---	---

The data point pool is currently designed for 300 data point diagrams with 100 software LED channels each.

The data point diagrams can be used multiple times in different function scenarios (e.g. in the Coming Home and Leaving Home scenarios). This makes it possible to use the memory in the Body Controller effectively.

In general: The parameters are written to the Body Controller via SCN codings during vehicle production. These parameters can differ for different model series or derivatives.

4266175
PV_ELC-23566

Functions of the scenarios

Repeat

The animated scenarios can be repeated via a parameter.

The repeat can also be merely part of the scenario; the starting time is variable and the end is always the end of the original scenario.

Deactivation animation

There are different options for the deactivation animation:

OFF (all brightnesses 0%)

Reverse: Play activation animation backward

Separate deactivation scenario

Fade over

By defining a target time for a function scenario, a fade over of the current light pattern into the starting light pattern of the requested scenario always takes place with the corresponding target time.

If the target time is defined as 0 s, a hard switchover between the light patterns takes place.

Example: Activate/deactivate tail lamp with a target time corresponds to a dimming on/off of the tail lamp pattern.

Multi-level functions

In different vehicle states (e.g. day/night), the brightnesses of the taillight / brake light / turn indicator functions can be adjusted using a factor.

Multi-level transition scenario => tbd

2.1.21.5.1.3

LPSR Functions (4266178)

4266177
PV_ELC-23572

The LPSR (Light Protocol Switch Rear) software component is a software element of BC-MMA that is implemented by the Body Controller supplier.

Mercedes-Benz - Confidential -	<small>Schutzvermerk DIN ISO 16016 beachten! /Refer to protection notice DIN ISO 16016! Keine Aenderung ohne Zustimmung der federfuehrenden Konstruktion / Any alterations are subject to the approval of the design department</small>	Bearb./auth.: Hans Peter Schiffert
	Technical Component Requirement Specifications Tail lamp QEY 111 AJPNLG	Abt./dep.: RD/KEL Datum/date: 2022-07-25 Requirement Specifications version: 001 Seite/page: 120 of 220

The LPSR is used to adjust the communication (brightness values, communication protocol, diagnosis functions) with the selected LED drivers.

The type of LED driver to be used shall be selected in the LPSR.

A maximum of 30 LED drivers with a total of 480 hardware LED channels can then be parameterized in the LPSR.

Which hardware LED channel is assigned to which software LED channel of the brightness array shall be configured. Multiple hardware LED channels can be assigned to one software LED channel.

The brightness values from the brightness array are adjusted to the output format of the selected LED driver and transmitted on the CAN.

Gamma correction

Linear dimming of LED light sources by means of pulse-width modulation (PWM) is not perceived as linear by the human eye. To achieve a visually linear dimming behavior, a non-linear function is used to calculate the PWM values.

The brightness values perceived by the human eye are saved in the data point pool. The definition of the brightness values for the data point pool shall take account of the gamma correction of the selected LED driver (GUI taillight function)

If the selected LED driver offers no internal back-calculation to "electrical" PWM values, the brightness values shall be corrected by the LPSR. For this purpose, a calculation has been defined that shall also be taken into account in the GUI taillight.

2.1.21.5.1.4

Abbreviations and Terms and Definitions (4266179)

4266181
PV_ELC-23563

ITC: Integrated Taillight Control (describes the actuation technology)

BC-MMA: Body Controller MMA

LMRA: Light Mapper Rear Advanced (software component in BC-MMA)

LPSR: Light Protocol Switch Rear (software component in BC-MMA,

<p>Mercedes-Benz - Confidential -</p>	<p><small>Schutzvermerk DIN ISO 16016 beachten! / Refer to protection notice DIN ISO 16016! Keine Aenderung ohne Zustimmung der federfuehrenden Konstruktion / Any alterations are subject to the approval of the design department</small></p> <p>Technical Component Requirement Specifications Tail lamp QEV 111 AJPNLG</p>	<p>Bearb./auth.: Hans Peter Schiffert Abt./dep.: RD/KEL Datum/date: 2022-07-25 Requirement Specifications 001 version: Seite/page: 121 of 220</p>
---	---	---

Task: Adjustment of communication to LED driver used))

LTC algorithm: Light Taillamp Control: Calculation algorithm for the brightness requests of the software LED channels

Software LED channels: LED channels that are calculated by the software.

Hardware LED channels: Physical LED channels (outputs on the LED drivers)

Data point diagram: A data point diagram contains the brightnesses for each of the 100 software LED channels.

Data point pool: The collection of different data point diagrams. A maximum of 300 data point diagrams is currently possible.

2.1.21.6 Cross-Functional Requirements Pertaining to the System (4266182)

2.1.21.6.1 Security (4266183)

4266180
PV_ELC-2874

The objective of vehicle security is to protect control units and systems from unauthorized access or alteration.

No safety-critical states shall be executable during driving for the exterior lighting system.

Safety-critical functions are described in the Chapter "Functional Safety".

4266184
PV_ELC-3305

During driving, no safety-relevant function shall be influenced by diagnosis (e.g. via extended programming / supplier session / i/O controls / routine and write services).

4266186
PV_ELC-6014

The protection is achieved by blocking the diagnosis services via the E2E-protected speed signals VehSpd_X_Max_ST3 and VehSpd_X_Qual_ST3 (from the ESP) starting at a speed of 10 km/h.

If an invalid speed signal is sent, the blocking of the services is canceled. (This prevents unintended blocking in production).

4266185
PV_ELC-4541

Deviating or expanded security measures shall be coordinated with the relevant component/system manager.

4266188
PV_ELC-3873

The development point from which the function will be activated shall be coordinated with the relevant component/system manager.

2.1.21.6.1.1 Protection against Manipulation (4266187)

4266189

The system shall provide mechanisms designed to prevent services or applications

Mercedes-Benz - Confidential -	<small>Schutzvermerk DIN ISO 16016 beachten! / Refer to protection notice DIN ISO 16016! Keine Aenderung ohne Zustimmung der federfuehrenden Konstruktion / Any alterations are subject to the approval of the design department</small>	Bearb./auth.: Hans Peter Schiffert
	Technical Component Requirement Specifications Tail lamp QEV 111 AJPNLG	Abt./dep.: RD/KEL Datum/date: 2022-07-25 Requirement Specifications 001 version: Seite/page: 122 of 220

SB-1085 *from being stopped, changed, interrupted, or seized.*

2.1.21.6.1.2 Software and Data Integrity, Confidentiality (4266192)

4266190
SB-1087 *The system shall provide mechanisms designed to ensure that software and data cannot be changed, added or deleted without authorization.*

4266193
SB-1088 *The system shall provide mechanisms designed to ensure the confidentiality of the software and data.*

2.1.21.6.1.3 Data Transmission via Secure Channels (4266191)

4266194
SB-1090 *The system shall provide mechanisms designed to establish and maintain secure communication channels.*

2.1.21.6.1.4 Robustness (4266198)

4266197
SB-1092 *The system shall provide mechanisms designed to ensure that the function of the system or individual components cannot be influenced.*

2.1.21.6.1.5 Safe Storage (4266195)

4266196
SB-1094 *The system shall provide suitable hardware and/or software measures designed to ensure that sensitive information is not disclosed.*

2.1.22 Requirements Pertaining to Involved Systems (4266199)

2.1.22.1 Systems Involved (4266203)

4266201
PV_ELC-21526 *Diagram of the Systems Involved.*

The detailed requirements of and for the exterior lighting system are shown in PREEVision

Mercedes-Benz - Confidential -	<small>Schutzvermerk DIN ISO 16016 beachten! /Refer to protection notice DIN ISO 16016! Keine Aenderung ohne Zustimmung der federfuehrenden Konstruktion / Any alterations are subject to the approval of the design department</small>	Bearb./auth.: Hans Peter Schiffert
	Technical Component Requirement Specifications Tail lamp QEV 111 AJPNLG	Abt./dep.: RD/KEL Datum/date: 2022-07-25 Requirement Specifications version: 001 Seite/page: 123 of 220

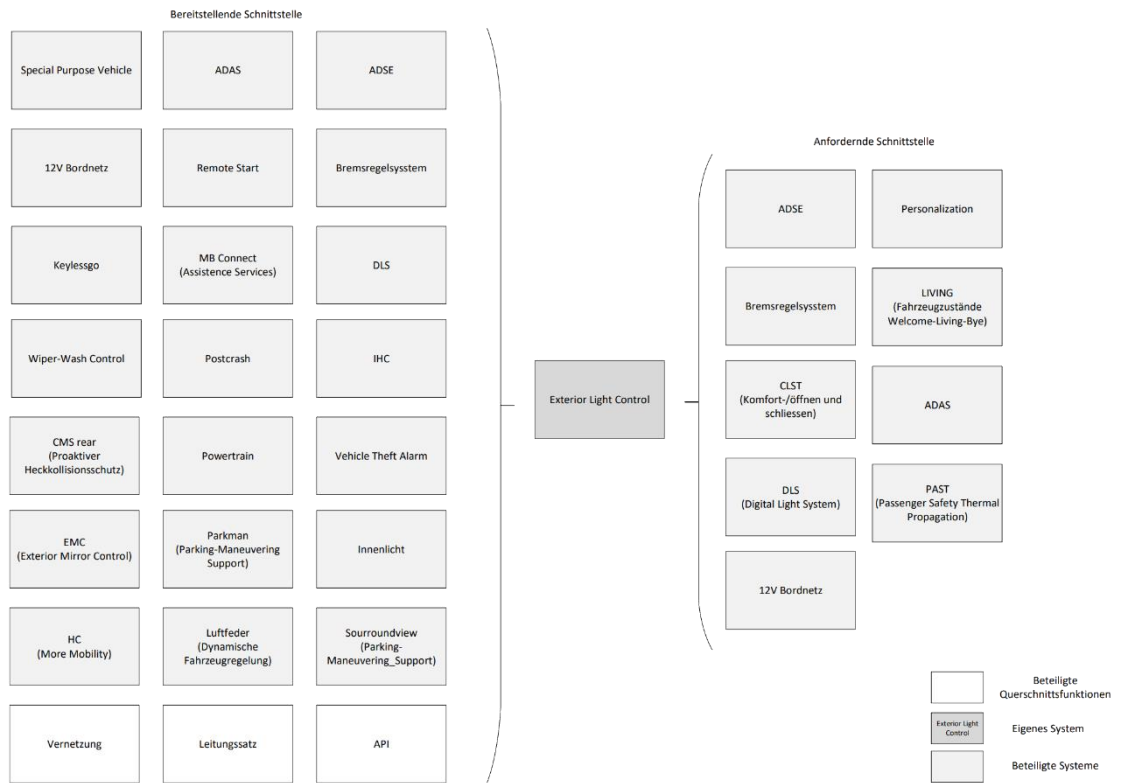

2.1.23 Requirements Pertaining to Involved Components (4266200)

2.1.23.1 Diagram of the Involved Components (4266202)

4266204
PV_ELC-4430

The diagram contains the component and software component contributions and establishes the relationship with structured analysis

Mercedes-Benz - Confidential -	Schutzvermerk DIN ISO 16016 beachten! /Refer to protection notice DIN ISO 16016! Keine Aenderung ohne Zustimmung der federfuehrenden Konstruktion / Any alterations are subject to the approval of the design department	Bearb./auth.: Hans Peter Schiffert Abt./dep.: RD/KEL Datum/date: 2022-07-25 Requirement Specifications 001 version: Seite/page: 124 of 220
	Technical Component Requirement Specifications Tail lamp QEV 111 AJPNLG	

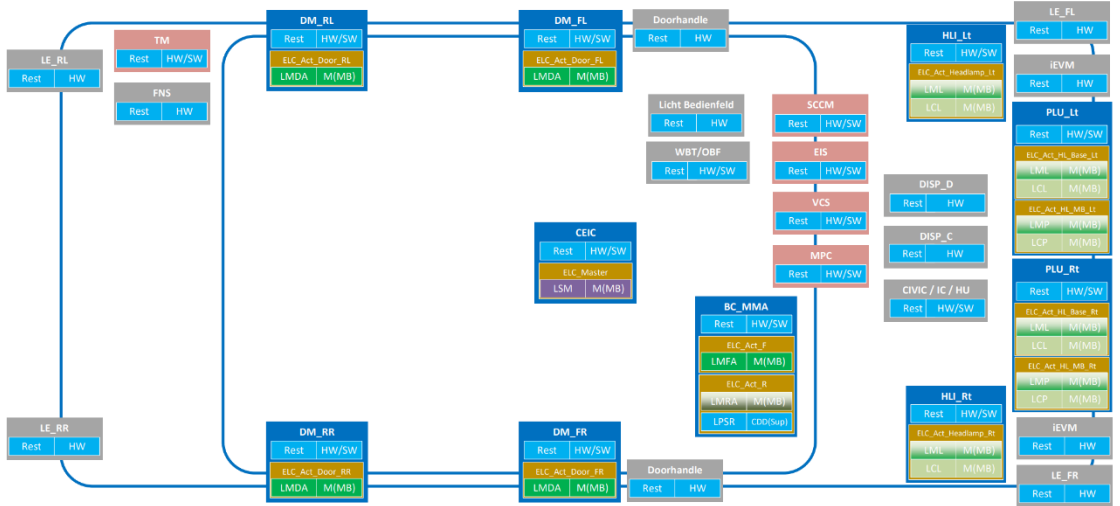

Komponenten (Steuergeräte)

- Komponentenbeitrag: Rest (HW / FuSi)
- Komponentenbeitrag: Rest (HW/SW/ FuSi / Sensorsignale)
- Komponentenbeiträge: Rest (HW / FuSi) + Softwarekomponenten

Komponenten- und Softwarekomponentenbeiträge

- System Component Contribution
- Softwarekomponente „Light System Master“ abgeleitet aus SA-Prozess „1_Funktionssteuerung“
- Softwarekomponente „Light Mapping“ Vario (m:n Funktions-Kanalzuordnung) abgeleitet aus SA-Prozess „2_FK-Mapper“
- Softwarekomponente „Light Channelcontrol“ abgeleitet aus SA-Prozess „3_Kanal-Strg“
- Softwarekomponente „Light Mapping + Dimmung“ Fix (feste Funktions-Kanalzuordnung) abgeleitet aus SA-Prozess „2_FK-Mapper“ und „3_Kanal-Strg“
- Softwarekomponente „Light Mapping + Dimmung“ Vario (m:n Funktions-Kanalzuordnung) abgeleitet aus SA-Prozess „2_FK-Mapper“ und „3_Kanal-Strg“
- Komponentenbeitrag „Rest“ abgeleitet aus SA-Prozess „4_Phys. Strg“ im Komponenten mit Softwarekomponenten

Abkürzungen:

- LSM Light System Master
- LMFA Light Mapping Front
- LMRA Light Mapping Rear Advanced
- LPSR Light Protocol Switch Rear
- LMDA Light Mapping Door
- LML Light Mapping LED
- LCL Light Channelcontrol LED
- LMP Light-Mapping Pixel
- LCP Light Channelcontrol Pixel
- LMDH Light Mapping Door Handle
- LE_Rx Leuchteinheit Rear
- LE_Fx Leuchteinheit Front
- WBT Wärmblinktaste
- IC Instrument Cluster
- HU Headunit
- IEVM intell. Energversorgungsmodul

2.1.23.2 Taillight Component (4266206)

2.1.23.2.1 Functional Safety Requirements (4266205)

2.1.23.2.1.1 Overview/Reference to Safety Objectives (4266207)

4266208
PV_ELC-947

As per the safety concept, the rear lamps in the exterior lighting system are involved in compliance with the following safety objectives:
 SZ_3-1: Preventing brake light failure (ASIL B)
 SZ_4-1: Preventing turn indicator failure (ASIL A)
 SZ_4-3: Preventing turn indicator activation on the wrong side (ASIL B)

2.1.23.2.1.2 Stop Lamp (4266209)

4266213
PV_ELC-464

Functional safety contribution of ZB taillight for SZ_3-1:

To ensure detectability of the brake application for the following traffic, the activation of the brake lights (BL) with sufficient luminous power is required. The left and right BL in the sidewall represent a full functional redundancy for the indication of the brake application to the following traffic. The raised BL and the BL in the trunk lid are not included in the safety concept since, depending on the situation (e.g. if the trunk lid is

Mercedes-Benz - Confidential -	Schutzvermerk DIN ISO 16016 beachten! /Refer to protection notice DIN ISO 16016! Keine Aenderung ohne Zustimmung der federfuehrenden Konstruktion / Any alterations are subject to the approval of the design department	Bearb./auth.: Hans Peter Schiffert Abt./dep.: RD/KEL Datum/date: 2022-07-25 Requirement Specifications version: 001 Seite/page: 125 of 220
	Technical Component Specifications Tail lamp QEV 111 AJPNLG	

open), they are possibly not visible for those behind. As a general rule, one brake light is considered sufficient to draw the attention of following traffic to a brake application.

The ZB rear lamp receives the request for activation of the brake lights redundantly from BC_MMA as a bus signal or as a hardware signal with the brake light redundancy line. If no valid signal is detected on the communication bus, the ZB taillight generates the actuation based on the brake light redundancy line

A fault relevant for the safety objective exists if, despite the presence of a request from BC_MMA, sufficient luminous power is not generated in the ZB taillight with the illuminants for the brake lights in the sidewall.

4266210
PV_ELC-3894

Warning and display concept:
In the event of a detected (partial) failure: Plain text message in the instrument cluster.

4266212
PV_ELC-3471

Data corruption in the bus signal with the brake light request from BC_MMA shall be safely detected in the sidewall lamps of the ZB rear lamp within the fault tolerance time [FTZ_BL_2]. This requires using end-to-end protection. The potential fault profiles in ISO 26262-6:2011 Annex D, D.2.4 shall be taken into account. At minimum, a high diagnosis quality ($\geq 99\%$) shall be achieved.

Fault response in the event of a detected end-to-end error: Activation of the brake light with sufficient luminous power depending on the brake light redundancy line after the fault tolerance time [FTZ_BL_1].

Reset condition: Valid brake status from BC_MMA available on the communication bus (without deceleration).

4266211
PV_ELC-20545

The following errors regarding the brake light in the sidewall lamp shall be reported to BC_MMA via the communication bus:

- Data corruption in the request from BC_MMA,
- Errors/failure of LED drivers,
- Errors in the LED modules that lead to brake light failure.

After detection, the error shall be reported on the communication bus within the fault tolerance time [FTZ_BL_3].

At minimum, a moderate diagnosis quality ($\geq 90\%$) shall be achieved.

4266214
PV_ELC-23533

The sidewall lamp shall not incorrectly signal a partial failure of the brake light via the communication bus to BC_MMA

4266217
PV_ELC-23535

For some variants, the function is deactivated on the affected side in the event of a reported partial failure

4266216
PV_ELC-20543

If there is a request on the communication bus, a luminous power sufficient for the brake light shall be generated by the illuminants in the LED modules in combination with the optical elements (including positioning) of the sidewall lamp

4266215
PV_ELC-20542

The status of the brake light redundancy line shall be read in by the sidewall lamps and sent to the BC_MMA via the bus interface.

4266218

The signal with the status information of the brake light redundancy line shall be

Mercedes-Benz - Confidential -	Schutzvermerk DIN ISO 16016 beachten! / Refer to protection notice DIN ISO 16016! Keine Aenderung ohne Zustimmung der federfuehrenden Konstruktion / Any alterations are subject to the approval of the design department	Bearb./auth.: Hans Peter Schiffert Abt./dep.: RD/KEL Datum/date: 2022-07-25 Requirement Specifications 001 version: Seite/page: 126 of 220
	Technical Component Requirement Specifications Tail lamp QEV 111 AJPNLG	

PV_ELC-20547

transmitted to the bus with end-to-end protection. The potential fault profiles in ISO 26262-6:2018 Annex D, D.2.4 shall be taken into account. At minimum, a high diagnosis quality ($\geq 99\%$) shall be achieved.

4266219
PV_ELC-20537

What is known as the brake light request from BC_MMA to ZB rear lamp can be done in one or more signals and depends on the design of the rear lamp. In so doing, the addressing and the brightness of an LED channel are usually transmitted.

4266220
PV_ELC-4383

Systematic errors that could lead to the failure of the brake lights in both sidewall lamps shall be avoided. Potential fault causes shall be identified and communicated to the client.

4266221
PV_ELC-4668

Fault tolerance times (FTT) with regard to SZ_3-1:

[FTZ_BL_1] Activation of the brake lights 20 ms after the appearance of the request on the communication bus at the latest

[FTZ_BL_2] Max. 200 ms until the activation of the brake lights on the basis of the brake light redundancy line

[FTZ_BL_3] Max. 2 s for the failure of a brake light; exclusively to avoid latent defects;

4266223
PV_ELC-3592

Safe state: Actuation of the brake lights in the sidewall lamps if there is a request from at least one of the two communication paths (bus or brake light redundancy line); no actuation if both paths validly request OFF.

(1) If there is an existing valid request via the communication bus: Actuation of the brake lights in the sidewall lamps as per the request from BC_MMA and output of the status of the brake light redundancy line to BC_MMA

(2) In the event of an error in the bus communication: Actuation of the brake lights in the sidewall lamps as per the brake light redundancy line and reporting of communication errors to BC_MMA via the communication bus

4266222
PV_ELC-155

The safe state at the vehicle level is when the brake light is activated during brake application.

This is triggered via BC_MMA; no additional reaction in the rear lamp is necessary in the event of errors.

2.1.23.2.1.3

Safety Requirements with Regard to Turn Signals (Failure) (4266224)

4266225
PV_ELC-4039

Functional safety contribution of ZB rear lamp for SZ_4-1:

The ZB rear lamp contributes to the availability of the rear turn signal or to the detectability of a defective turn indicator by generating the luminous power in the turn signal-relevant LED modules on the basis of the request from BC_MMA and error detection.

A fault relevant for the safety objective exists if in the ZB taillight, due to an error - the LED modules that belong to the turn indicator are not actuated, or not with sufficient luminous power, despite an existing FRA request from BC_MMA, or - an existing error is not detected or is not reported to BC_MMA.

If the request from BC_MMA is distorted along the communication channel (data

Mercedes-Benz - Confidential -	<small>Schutzvermerk DIN ISO 16016 beachten! / Refer to protection notice DIN ISO 16016! Keine Aenderung ohne Zustimmung der federfuehrenden Konstruktion / Any alterations are subject to the approval of the design department</small>	Bearb./auth.: Hans Peter Schiffert Abt./dep.: RD/KEL Datum/date: 2022-07-25 Requirement Specifications 001 version: Seite/page: 127 of 220
	Technical Component Requirement Specifications Tail lamp QEV 111 AJPNLG	

corruption or failure), the ZB rear lamp will deactivate the turn indicator outputs with an error message to BC_MMA.

4266226
PV_ELC-3601

*Warning and display concept:
In the event of a detected failure of a turn indicator: Frequency of visual and acoustic feedback doubles in the instrument cluster. In addition: Plain text message.*

4266227
PV_ELC-3537

If there is a request on the communication bus, a luminous power sufficient for the turn indicator shall be generated by the illuminants in the LED modules in combination with the optical of the sidewall lamp. Insufficient luminous power exists if

- the resulting light-dark phases cannot be sufficiently differentiated or
- the frequency of the light-dark phases no longer corresponds to the turn signaling function.

4266228
PV_ELC-20539

What is known as the turn signal request from BC_MMA to ZB rear lamp can be done in one or more signals and depends on the design of the rear lamp. In so doing, the addressing and the brightness of an LED channel are usually transmitted.

4266229
PV_ELC-20548

The signal with the status information or the error statuses of the turn indicator shall be transmitted to the bus with end-to-end protection. The potential fault profiles in ISO 26262-6:2011 Annex D, D.2.4 shall be taken into account. At minimum, a high diagnosis quality ($\geq 99\%$) shall be achieved.

4266233
PV_ELC-20546

The following errors [FTZ_FRA_1] regarding the turn signal shall be reported to BC_MMA via the communication bus within the fault tolerance time:

- Data corruption in the request from BC_MMA
- Errors/failure of LED drivers,
- Errors in the LED modules that lead to turn signal failure.

At minimum, a moderate diagnosis quality ($\geq 90\%$) shall be achieved.

4266232
PV_ELC-6066

Safe state: Error detected and reported to BC_MMA via the communication bus

4266231
PV_ELC-3146

Fault tolerance time (FTT) regarding SZ_4-1:
[FTZ_FRA_1] 150 ms.

4266230
PV_ELC-263

The times for the flasher frequency during turn signaling are technically between 660 ms (light phase 340 ms) and 800 ms (light phase 400 ms). Time parameters in the requests (FTT, etc.) have been specified with respect to the shortest flasher cycle. The dynamic turn signal function refers to the overall light phase.

Depending on the design of the lamp, the light phase can be reduced down to 150 ms for the individual segments.

2.1.23.2.1.4

Safety Requirements with Regard to Turn Signals (Activation on the Wrong Side) (4266234)

4266239
PV_ELC-4845

Functional safety contribution of ZB taillight for SZ_4-3:

The ZB taillight contributes to correct turn signaling at the rear through the correct

Mercedes-Benz - Confidential -	<small>Schutzvermerk DIN ISO 16016 beachten! / Refer to protection notice DIN ISO 16016! Keine Aenderung ohne Zustimmung der federfuehrenden Konstruktion / Any alterations are subject to the approval of the design department</small>	Bearb./auth.: Hans Peter Schiffert
	Technical Component Requirement Specifications Tail lamp QEV 111 AJPNLG	Abt./dep.: RD/KEL Datum/date: 2022-07-25 Requirement Specifications 001 version: Seite/page: 128 of 220

generation of luminous power in the turn indicator-relevant LED modules on the basis of the request from BC_MMA.

A fault relevant for the safety objective exists if in the ZB taillight, with an existing request from BC_MMA, a luminous power is generated for one side with discernible light-dark phases in the turn indicator source on the other side.

4266236
PV_ELC-6112

Warning and display concept:
In the event of targeted deactivation of a turn indicator: Frequency of visual and acoustic feedback doubles in the instrument cluster. In addition: Plain text message.

4266237
PV_ELC-5678

In the turn indicator-relevant light source in the ZB rear lamp, no luminous power (worst case: in flasher frequency) shall be generated if there is no request from BC_MMA on the communication bus.

4266235
PV_ELC-1715

If there is another error (turn indicator failure or bus communication failure), this fault profile leads to a violation of the safety objective.

4266238
PV_ELC-2677

Data corruption in the bus signal with the turn signaling from BC_MMA shall be safely detected in the ZB rear lamp within the fault tolerance time [FTZ_FRA_2]. This requires using end-to-end protection.

The potential fault profiles in ISO 26262-6:2011 Annex D, D.2.4 shall be taken into account. At minimum, a high diagnosis quality ($\geq 99\%$) shall be achieved.

Fault response in the event of a detected E2E error: Deactivation of the turn indicator outputs by the tail lamp with report to BC_MMA

Reset condition: Valid turn indicator request from BC_MMA detected on the communication bus

4266240
PV_ELC-20538

What is known as the turn signal request from BC_MMA to ZB rear lamp can be done in one or more signals and depends on the design of the rear lamp. In so doing, the addressing and the brightness of an LED channel are usually transmitted.

4266243
PV_ELC-20540

Systematic faults that can lead to a laterally reversed actuation of the turn indicators in the rear lamps shall be prevented. Potential fault causes in the ZB rear lamp shall be identified and communicated to the client.

4266241
PV_ELC-4643

Safe state:
Report deactivation of turn indicator and status to BC_MMA via the communication bus

4266242
PV_ELC-894

Fault tolerance time (FTT) regarding SZ_4-3:
[FTZ_FRA_2] max. 660 ms (one flasher frequency)

2.1.23.2.1.5

Cross-Functional Safety Requirements (4266244)

4266248
PV_ELC-3810

All components of the ZB rear lamp shall basically be included in the safety case, i.e. from the connector plug to the vehicle wiring harness up to and including the illuminant. This also applies if no specific ASIL attribute was set for requirements in this requirement specifications chapter.

The overall responsibility for the integration of the individual components in the ZB

Mercedes-Benz - Confidential -	<small>Schutzvermerk DIN ISO 16016 beachten! / Refer to protection notice DIN ISO 16016! Keine Aenderung ohne Zustimmung der federfuehrenden Konstruktion / Any alterations are subject to the approval of the design department</small>	Bearb./auth.: Hans Peter Schiffert Abt./dep.: RD/KEL Datum/date: 2022-07-25 Requirement Specifications 001 version: Seite/page: 129 of 220
	Technical Component Requirement Specifications Tail lamp QEV 111 AJPNLG	

rear lamp remains with the rear lamp supplier.

4266245
PV_ELC-4462

The overall responsibility for the integration of the individual components includes, among other things, ensuring the technical boundary conditions in the ZB rear lamp that are necessary for compliance with the safety requirements (e.g. cooling, internal wiring harness).

4266246
PV_ELC-2010

Depending on the selected technical safety concept, it is possible that functional contents from the technical safety concept are also required for fulfilling the functional safety requirements. An identification as safety-relevant, the assignment if necessary of an ASIL attribute, shall in this case take place on the component level.

4266247
PV_ELC-1858

For electrical/electronic components (e.g. LED modules), the requirements from ISO 26262 shall basically be implemented according to the respective ASIL classification.

4266249
PV_ELC-4088

For other non-electric/electronic components (e.g. mechanical systems, wiring harness), specific standards may have to be observed. Verification of the reliability via suitable methods for design validation (e.g. field evaluation, qualification results, design/process FMEA) shall at least be provided for such components.

4266253
PV_ELC-2992

The tolerances specified in the functional requirements are basically considered the acceptance criteria for the safety requirements for achieving a sufficient luminous power. If better suited acceptance criteria are identified on the component side due to the technical implementation, these can be used after agreement with the client.

2.1.23.2.2

ITC (Integrated Taillight Control) Requirements (4266252)

2.1.23.2.2.1

ITC Description (4266250)

4266251
PV_ELC-22535

ITC (Integrated Taillight Control) describes the type of rear lamp actuation through a physical CAN interface with a UART or a CAN communication protocol. The actuation is done by a master control unit.

In total, there are two CAN interfaces (ITC-CAN1 and ITC-CAN2) for the actuation of all tail lamp elements in the vehicle.

4266254
PV_ELC-22532

Example of a possible ITC topology in the vehicle.

Mercedes-Benz - Confidential -	<small>Schutzvermerk DIN ISO 16016 beachten! /Refer to protection notice DIN ISO 16016! Keine Aenderung ohne Zustimmung der federfuehrenden Konstruktion / Any alterations are subject to the approval of the design department</small>	Bearb./auth.: Hans Peter Schiffert
	Technical Component Requirement Specifications Tail lamp QEV 111 AJPNLG	Abt./dep.: RD/KEL Datum/date: 2022-07-25 Requirement Specifications 001 version: Seite/page: 130 of 220

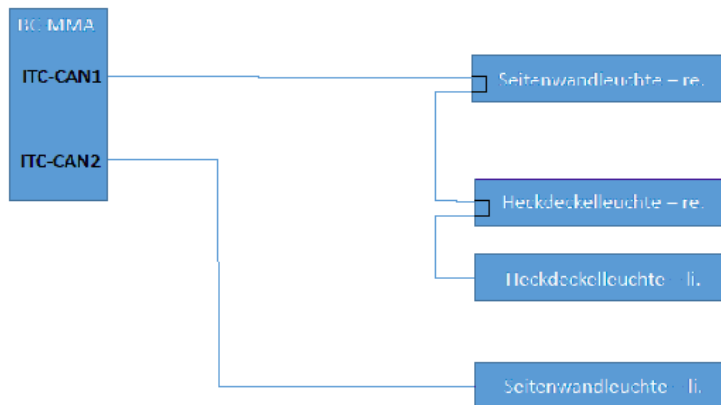

2.1.23.2.2.2 Actuation of Light Functions (4266259)

4266255
PV_ELC-22641

The rear lamp elements are powered by a terminal 30 engaged by the master control unit. Additionally, the sidewall lamps are powered by a redundantly engaged terminal 15 in order to be able to provide emergency function in the event of a failure of the master control unit.

4266256
PV_ELC-22655

All light functions of the rear lamp are actuated via the communications interface.

4266257
PV_ELC-22642

The status of the current actuation shall be reported for each individual hardware LED channel via the communications interface. ON/OFF/Error.

4266258
PV_ELC-22692

The status of the current actuation for each LED driver can be sent sequentially. The current status of each driver shall be available every 100 ms.

2.1.23.2.2.2.1 Behavior in the Event of Errors on the Communication Interface (4266260)

2.1.23.2.2.2.1.1 Tail Light (4266261)

4266263
PV_ELC-22646

The tail light elements of the rear lamps shall autonomously activate themselves after a timeout period of 1 s in the event of active power supply with disrupted communication with the master control unit.

2.1.23.2.2.2.1.2 Stop Lamp (4266262)

4266264
PV_ELC-22648

See functional safety requirements for the rear lamp.

4266268
PV_ELC-22656

The brake light elements of the rear lamps shall be actuated after a timeout period

Mercedes-Benz - Confidential -	<small>Schutzvermerk DIN ISO 16016 beachten! /Refer to protection notice DIN ISO 16016! Keine Aenderung ohne Zustimmung der federfuehrenden Konstruktion / Any alterations are subject to the approval of the design department</small>	Bearb./auth.: Hans Peter Schiffert Abt./dep.: RD/KEL Datum/date: 2022-07-25 Requirement Specifications version: 001 Seite/page: 131 of 220
	Technical Component Requirement Specifications Tail lamp QEV 111 AJPNLG	

dependent on the brake light redundancy line in the event of active power supply with disrupted communication with the master control unit.

4266266
PV_ELC-22649

The status (ON/OFF) of the brake light redundancy line shall be able to be read back via the communications interface. The query takes place every 100 ms.

2.1.23.2.2.2.1.3 Turn Indicators (4266265)

4266267
PV_ELC-22650

See functional safety requirements for the rear lamp.

2.1.23.2.2.2.1.4 Reversing Light (4266269)

4266270
PV_ELC-22647

In the event of a communication failure with the master control unit, the reversing light function shall be deactivated after a timeout period of 1 s.

2.1.23.2.2.2.1.5 Rear Fog Light (4266272)

4266273
PV_ELC-22645

In the event of a communication failure with the master control unit, the rear fog light function shall be deactivated after a timeout period of 1 s.

2.1.23.2.2.2.2 Tests of the Emergency Running Characteristics in Taillight Production (4266271)

4266274
PV_ELC-22838

The following tests shall be performed and documented for the end-of-line check of the rear lamp.

4266275
PV_ELC-22839

The documentation of the OK test result shall be stored for 15 years.

4266277
PV_ELC-22841

The lamps shall be put in a defined state in which the respective emergency running property is active. To this end, Hardware inputs in the rear lamp shall potentially have to be stimulated accordingly; the behavior shall then be tested for correctness in a suitable form.

4266278
PV_ELC-22837

The correct function of the tail light shall be tested in the event of errors on the communications interface.

4266276
PV_ELC-22840

The correct function of the brake light shall be tested in the event of errors on the communications interface.

2.1.23.2.2.3 Number of LED Channels/Number of LED Drivers Supported by SW (4266279)

4266283
PV_ELC-22561

<p>Mercedes-Benz - Confidential -</p>	<p style="text-align: center;"><small>Schutzvermerk DIN ISO 16016 beachten! /Refer to protection notice DIN ISO 16016! Keine Aenderung ohne Zustimmung der federfuehrenden Konstruktion / Any alterations are subject to the approval of the design department</small></p> <p style="text-align: center;">Technical Component Requirement Specifications Tail lamp QEV 111 AJPNLG</p>	<p>Bearb./auth.: Hans Peter Schiffert Abt./dep.: RD/KEL Datum/date: 2022-07-25 Requirement Specifications 001 version: Seite/page: 132 of 220</p>
--	--	---

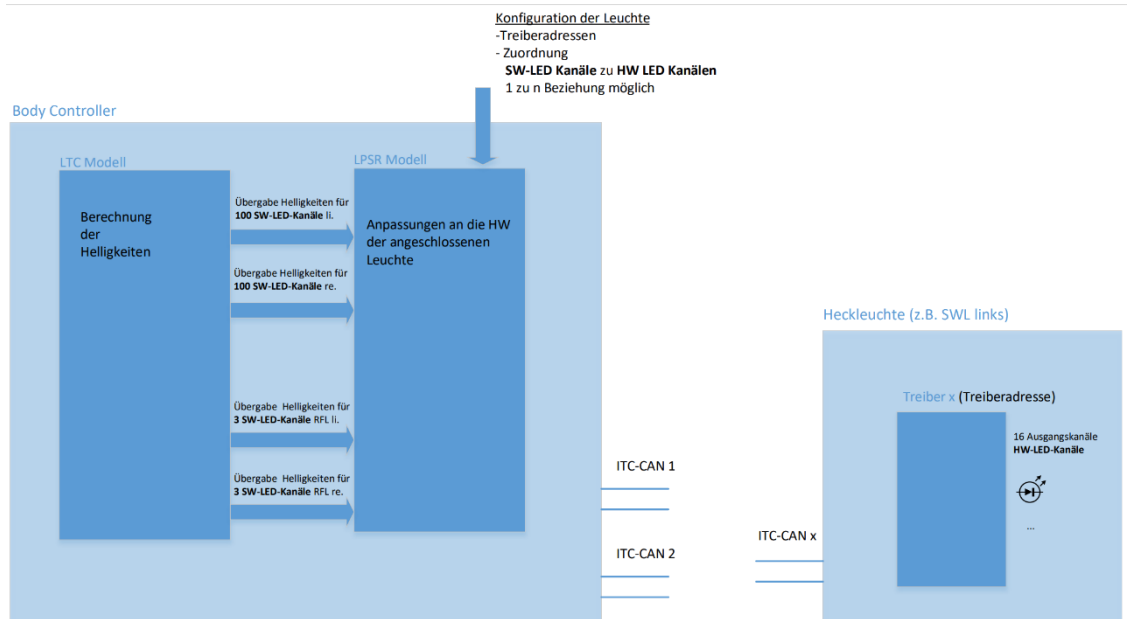

4266280
PV_ELC-22531

The maximum number of SW LED channels separately computable for brightness that is supported and addressed by the software is 100 channels per vehicle side.

4266282
PV_ELC-22534

These channels can have any distribution of the tail light, brake light, turn indicator, and rear fog light functions.

4266281
PV_ELC-22537

A SW LED channel can be assigned several functions.

4266284
PV_ELC-22539

Three separate SW LED channels for the reversing light function on each vehicle side.

4266288
PV_ELC-22541

The maximum number of LED driver modules that can be actuated is 30. This leads to a maximum number of hardware LED channels of 480, with 30 drivers x 16 channels.

4266286
PV_ELC-22545

It is possible to actuate several hardware LED channels through a software LED channel (implementation in the software of the master control unit)

2.1.23.2.2.4

Validation of ITC CAN Bus Physics (4266285)

4266287
PV_ELC-22542

A signal integrity analysis (simulation) of the network physics shall be prepared with the selected driver and the data provided by the client regarding the vehicle wiring harness and the CAN transceiver in the master.

4266289
PV_ELC-22552

The simulation shall include the communication from the master ECU to every LED driver and the communication from the LED drivers to the master ECU.

4266291
PV_ELC-22553

The simulation shall take the defined temperature range of the rear lamp into account.

4266293
PV_ELC-22557

The simulation shall be carried out with the baud rate determined in accordance with the bus load calculation.

4266292
PV_ELC-22556

The following data shall be presented as results:

- Appropriate distribution of the taillight elements between interfaces ITC-CAN1 and

Mercedes-Benz - Confidential -	Schutzvermerk DIN ISO 16016 beachten! /Refer to protection notice DIN ISO 16016! Keine Aenderung ohne Zustimmung der federfuehrenden Konstruktion / Any alterations are subject to the approval of the design department	Bearb./auth.: Hans Peter Schiffert Abt./dep.: RD/KEL Datum/date: 2022-07-25 Requirement Specifications 001 version: Seite/page: 133 of 220
	Technical Component Requirement Specifications Tail lamp QEV 111 AJPNLG	

ITC-CAN2

- Adjustment/determination of the sampling points.
- The network margin / safety margin for the selected settings and terminations, for the transmission of the nodes and of the master respectively.
- The longest delay for the respective transmitter shall be sufficiently smaller than the network margin for this transmitter.
- Data settle time including ringing and signal symmetry between the nodes

4266290
PV_ELC-22550

The simulation shall be carried out with various termination options.

4266294
PV_ELC-22555

The determination of the termination is made jointly by the contractor and the client.

4266297
PV_ELC-22554

The simulation results shall be provided to the client.

4266296
PV_ELC-22551

The results of the simulation shall be submitted with the offer presentation. In the event of changes to the electronics of the lamp (PCB, driver, internal wiring), the simulation shall be carried out again.

2.1.23.2.2.5

Requirements for the Communication Interface (4266295)

4266298
PV_ELC-22549

The LED drivers shall have a physical CAN/CAN-FD interface
The requirements for the physical layer in the [MSS 20202] "CAN Networking Performance Specification" shall be complied with.

4266299
PV_ELC-22559

A CAN-FD or a UART protocol shall be used as the communication protocol.

4266303
PV_ELC-22558

The "Common Oscillator Requirements" in [MSS 20202] Chapter 8.6.1 shall be observed.
The requirements regarding bit timing can also be ensured through additional mechanisms, such as the synchronization of the communication speeds.

4266301
PV_ELC-22693

The maximum bus load for the communications interface, including the cyclical diagnosis queries, shall not exceed 80%.

2.1.23.2.2.6

Development/Production Status of the Taillight (4266302)

4266300
PV_ELC-22639

Using a diagnosis command from the master control unit, it shall be possible to read out the state of development/state of production of the rear lamp. At least 1 byte shall be reserved in the memory of the LED driver for this purpose.

2.1.23.2.3

Hardware Requirements for the Taillight (4266304)

2.1.23.2.3.1

PWM Frequency for the Actuation of the LEDs (4266308)

4266305
PV_ELC-22633

The PWM frequency of LED actuation shall be a common multiple of the common network frequencies 50 Hz/60 Hz, with a maximum tolerance of +/-3%, e.g. 300 Hz +/-3%.

Mercedes-Benz - Confidential -	<small>Schutzvermerk DIN ISO 16016 beachten! /Refer to protection notice DIN ISO 16016! Keine Änderung ohne Zustimmung der federführenden Konstruktion / Any alterations are subject to the approval of the design department</small>	Bearb./auth.: Hans Peter Schiffert
	Technical Component Requirement Specifications Tail lamp QEV 111 AJPNLG	Abt./dep.: RD/KEL Datum/date: 2022-07-25 Requirement Specifications version: 001 Seite/page: 134 of 220

2.1.23.2.3.2

Redundant Power Supply for the Taillight (4266307)

4266306
PV_ELC-22636

After a vehicle crash, even in the event of failure of the Body Controller, emergency illumination of the rear lamps shall be ensured (requirement from the PostCrash system).

4266309
PV_ELC-22631

The sidewall lamps are each connected to two independent power supplies.

4266311
PV_ELC-22635

In the event of normal function, the Body Controller takes over control of the activation and deactivation times of both supply voltages, so that there are no unintended activation or deactivation reactions.

4266313
PV_ELC-22638

The rear lamp shall ensure that the various voltages do not cause any feedback for the respective other supply voltage.

4266310
PV_ELC-22657

The rear lamp shall also function without restrictions if only one of the two voltages is applied.

4266312
PV_ELC-22690

Both supplies of the rear lamp are tested by alternating on/off switching and a communication test for timeout.

2.1.23.2.4

General Requirements (4266314)

2.1.23.2.4.1

On-Board Electrical System Requirements (4266317)

4266316
PV_ELC-21914

The requirements in this chapter apply to all systems and components that read in inputs relevant for exterior lighting, actuate outputs for light functions, or implement light functions in the vehicle.

4266315
PV_ELC-21912

If inputs can still be read in with undervoltage or overvoltage, these states shall be correctly reported to the application.

4266318
PV_ELC-21911

The ELC system is assigned to the operating voltage in accordance with function class 2 (see MBN 10567) or BC_x3 and shall comply with these definitions.

4266319
PV_ELC-21916

In the event of overvoltage, the following shall be implemented:
- for timed (active PWM control) outputs, normal control takes place up to approx. 20 V. If the voltage continues to increase, the last PWM value (20 V) is retained.
- for non-timed or current-controlled outputs, there is no reaction to the overvoltage, i.e. normal actuation takes place (if needed, derating at the base temperature).

4266320
PV_ELC-21907

For light functions, it shall be possible to activate these light-relevant outputs in an expanded voltage range of 7-19 V compared to MBN 10567 or for these to remain active if they were so previously.

4266323
PV_ELC-21910

The light-relevant outputs shall not be switched off beyond the limits in accordance with PV_ELC-21907, as long as the hardware used enables actuation.

Mercedes-Benz - Confidential -	<small>Schutzvermerk DIN ISO 16016 beachten! /Refer to protection notice DIN ISO 16016! Keine Aenderung ohne Zustimmung der federfuehrenden Konstruktion / Any alterations are subject to the approval of the design department</small>	Bearb./auth.: Hans Peter Schiffert
	Technical Component Requirement Specifications Tail lamp QEV 111 AJPNLG	Abt./dep.: RD/KEL Datum/date: 2022-07-25 Requirement Specifications 001 version: Seite/page: 135 of 220

2.1.23.2.4.2 Latency Periods (4266321)

4266322
PV_ELC-21906

After the bus wake-up, all application messages (including E2E and SEC/OC, if defined) shall be sent to the bus system within 300 msec at most

4266324
PV_ELC-21913

The maximum time for the activation or modification of an output (HSD/converter) nach after receipt of a request via bus signal or hardware input is 30 msec in active operation

4266325
PV_ELC-21908

The maximum time for the activation or modification of an output (HSD/converter) after bus wake-up can be found in the defined activation times in the "CAN Networking Performance Specification"

2.1.24 Annex (4266329)

2.1.24.1 Normative References (4266328)

4266326
SB-166

Hex dump specification for load spectra (MGU 00000426)

4266327
PV_ELC-22725

CAN networking performance specification (MSS 20202)

4266331
PV_ELC-22729

End-to-end communication protection (QEV111AES5MSS)

4266332
PV_ELC-22728

Specification of SWC-C end-to-end communication protection library (AUTOSAR_SWS_E2ELibrary)

2.1.25 Requirements for the Process (Process Requirement Specifications - PLH) (3120440)

4622664

This version of the taillight process requirement specifications (PRS) is V1.7 dated March 1, 2022.

3120442

The process requirements described in the PLH represent a standard and support the supplier in looking for the ideal process in terms of costs, deadline (incl. cycle time), and the quality of the process and thus of the component. It especially takes into account problems/fault possibilities of the past, which are to be ruled out in the future. It thus has a significant practical relevance, This PLH does NOT release the supplier from its obligation to search for the best or better processes than those described in this PLH. If these processes deviate from these process requirement specifications (PLH), the supplier shall submit these to the Mercedes-Benz AG Quality Management department and Development department.

3120443

During development of the production process, the supplier shall implement preventive maturity level monitoring in the form of preventive maturity level management, including the specification of the characteristic data (verification of process capability, inspections, etc.).

Mercedes-Benz - Confidential -	<small>Schutzvermerk DIN ISO 16016 beachten! /Refer to protection notice DIN ISO 16016! Keine Aenderung ohne Zustimmung der federfuehrenden Konstruktion / Any alterations are subject to the approval of the design department</small>	Bearb./auth.: Hans Peter Schiffert Abt./dep.: RD/KEL Datum/date: 2022-07-25 Requirement Specifications version: 001 Seite/page: 136 of 220
	Technical Component Requirement Specifications Tail lamp QEV 111 AJPNLG	

3120453 The state of development of the production process shall be documented on a continuous basis by the documents specified in Chapter "Preventive Maturity Level Management" and presented to the Quality Management and Development departments at Mercedes-Benz AG at regular intervals (at least for every product gate as per the MDS).

2.1.25.1 Preventive Maturity Level Management (3120450)

3120457 *Preventative maturity level management is carried out after consulting with the Quality Management department at Mercedes-Benz AG. All of the supplier's departments involved in the product creation process shall be subject to maturity level management.*

3120516 The supplier is responsible for the maturity level management of the sub-suppliers. If required, the status shall be presented to the Quality Management department at Mercedes-Benz AG at any time. This requirement is independent of the applied directed part assignment matrix (A, B, C or D).

3157541 *The assessment of the maturity level is based on defined quality objectives and quality criteria along the product and process development process.*

3120524 The facilities and tools shall be commissioned, built, approved and run in the context of the coordinated schedule.

3120525 For the case that several lines are set up, a pilot line shall be qualified in advance and validated before further lines are put into service. Deviations from this procedure must be coordinated with the responsible Quality area.

3120527 All state-of-the-art preventative quality and technology assurance methods shall be used (e.g. simulating methods, such as filling studies for injection molding, tolerance simulations, etc.)

2.1.25.1.1 Start of Preventive Maturity Level Management (3157542)

3157544 Following consultation with Mercedes-Benz AG Quality Management, maturity level management shall begin right at the start of the development and design phase and the component production process. The maturity level progress shall be revealed to the quality management department at regular intervals at the product gates according to MDS. The requirements listed in the component requirement specifications and PLH are to be verified.

2.1.25.1.2 Scope (3157545)

3157546 *Preventive maturity level monitoring involves monitoring the degree of fulfillment of all requirements specified during the product creation process.*

3157547 *The requirements for the part (functional and non-functional) and for the process shall be taken into account.*

<p>Mercedes-Benz - Confidential -</p>	<p><small>Schutzvermerk DIN ISO 16016 beachten! /Refer to protection notice DIN ISO 16016! Keine Aenderung ohne Zustimmung der federfuehrenden Konstruktion / Any alterations are subject to the approval of the design department</small></p> <p>Technical Component Requirement Specifications Tail lamp QEV 111 AJPNLG</p>	<p>Bearb./auth.: Hans Peter Schiffert Abt./dep.: RD/KEL Datum/date: 2022-07-25 Requirement Specifications 001 version: Seite/page: 137 of 220</p>
---	--	---

3157548

The assessment is performed based on the degree of implementation at the coordinated period. The maturity level is split up into four stages:

- The requirement is not implemented by the deadline
- The requirement is currently being implemented
- The requirement is implemented by the deadline
- The requirements is implemented by the deadline and tested successfully

2.1.25.1.3 Scheduling (3157549)

3157550

In addition to the Mercedes milestones, the following industrialization milestones shall also be listed in the supplier schedule.

3157551

The indicated milestones () shall be implemented by the specified deadline.*

<p>Mercedes-Benz - Confidential -</p>	<p><small>Schutzvermerk DIN ISO 16016 beachten! /Refer to protection notice DIN ISO 16016! Keine Aenderung ohne Zustimmung der federfuehrenden Konstruktion / Any alterations are subject to the approval of the design department</small></p> <p>Technical Component Requirement Specifications Tail lamp QEV 111 AJPNLG</p>	<p>Bearb./auth.: Hans Peter Schiffert Abt./dep.: RD/KEL Datum/date: 2022-07-25 Requirement Specifications 001 version: Seite/page: 138 of 220</p>
---	--	---

Termin	Monate vor SOP (Job #1)	Bemerkungen
* Werkzeuge am Serienstandort (freigegeben / abgemustert)	9	in Abhängigkeit zu PPFB (2 Monate vor PPFB-Start), Teile für letzte Erprobungsschleife
* Fertigungsequipment am Serienstandort - Ende	12	Planung Lief. In Abhängigkeit "dunkelgrün"
* Fertigung erste Teile aus Serienequipment (Serienstandort)	12	
* Erstellung Prüfmittel Lieferant abgeschlossen und am Serienstandort vorhanden	16	zu ESWFT
* Prüfmittelfähigkeit nachgewiesen (Verfahren 1+2)	14	Optimierungen sind final bis Nachweis PPFB-Fähigkeit abgeschlossen (bei -8)
* Korrelation Prüfmittel zueinander ZB-Messaufnahme 3D / Inlinemessung		zu PRO1 Teilefertigung / Vorgabe Projekt#, 100% CMM Messung bei fehlender Korrelation
* ggf. Abgleichmessung ZB-Lehre / Messaufnahme Lieferant zu DAI-ZB-Lehre / Mesaufnahme	14	
* Nachweis Prozessfähigkeit 1 (Kurzzeitfähigkeit)	8	Kurzzeitfähigkeit Montage / Lichteinstellung / Geometrie nachgewiesen mit Bemusterungsfähigkeit
* BSM (MPB) für Werkstoff (z.B. Lackprüfung Abdeckscheibe, Korrosion, Polymere)	7	Werkstoffprüfungen werden als BSM durchgeführt
* Personalplanung abgeschlossen / Trainingsmatrix erstellt	8	
* Bewertung PPFB Fähigkeit (Bewertung ob alle Anforderungen zum Start PPFB gewährleistet sind, mindestens "gelb" fähig)	8	1 Monat vor PPFB
* Zertifizierung abgeschlossen (ECE / SAE / CCC)	7	mit Einsatz PIA spätestens zur Freigabe gelb (bei -5)
* Start PPFB (Anlieferung PPFB-Teile bei DAI, Dokumentation in SQMS vollständig)	7	
* Gelb Freigabe PPFB	5	
* Nachweis Prozessfähigkeit 2 (R@R bestanden, Audit durchgeführt, CP erfüllt, alle Beanstandungen aus "Gelb" PPFB und PROs abgearbeitet)	3	mit grün
* Grün Freigabe PPFB	3	

2.1.25.1.4

Documentation of Maturity Level Up to SOP (3157871)

3157872

For verification of the development of the degree of maturity for the part and process, the following verifications/documents shall be produced for each build lot of the null series (BL 1- BL x) and the production trials (PROs) (1 - x):

Mercedes-Benz - Confidential -	<small>Schutzvermerk DIN ISO 16016 beachten! / Refer to protection notice DIN ISO 16016! Keine Änderung ohne Zustimmung der federführenden Konstruktion / Any alterations are subject to the approval of the design department</small>	Bearb./auth.: Hans Peter Schiffert Abt./dep.: RD/KEL Datum/date: 2022-07-25
	Technical Component Requirement Specifications Tail lamp QEV 111 AJPNLG	Requirement Specifications 001 version: Seite/page: 139 of 220

3157873

During the null series:

- Measurement reports for all lamps delivered to Mercedes (assignment of measurement report to lamp shall be ensured)
- Graphic assessment of the measurement reports and description of a control chart
- Updated fault identification chart (decorative characteristics)
- Self-disclosure for part and process
- Current parts history
- Updated "Process Reporting" form
- Updated form for manufacturability and tolerance achievement for PPA report

3157874

During the production trials:

- Measurement reports for all lamps delivered to Mercedes (assignment of measurement report to lamp shall be ensured)
- Graphic assessment of the measurement reports and description of a control chart
- Updated fault identification chart (decorative characteristics)
- Self-disclosure for part and process (up to PPAR)
- Current parts history (up to PPAR)
- Evaluation of internal performance test with approach curve for reaching full capacity production

2.1.25.1.5

Maturity Level Monitoring after the Start of Series Production (3157953)

3157954

In special cases, further maturity level monitoring may be necessary during current series production.

3157955

As per MBST 13, consultation with the Quality Management department at the receiving Mercedes-Benz AG plant is required before making any changes to an existing production process and product. The obligation to inform the supplier is according to the time frame specified in the MBST.

<p>Mercedes-Benz - Confidential -</p>	<p><small>Schutzvermerk DIN ISO 16016 beachten! /Refer to protection notice DIN ISO 16016! Keine Aenderung ohne Zustimmung der federfuehrenden Konstruktion / Any alterations are subject to the approval of the design department</small></p> <p>Technical Component Requirement Specifications Tail lamp QEV 111 AJPNLG</p>	<p>Bearb./auth.: Hans Peter Schiffert Abt./dep.: RD/KEL Datum/date: 2022-07-25 Requirement Specifications 001 version: Seite/page: 140 of 220</p>
---	--	---

- 3157957 Moreover, the following time frames for providing preliminary information to Mercedes-Benz AG Quality Management regarding the component parts shall be observed:
- Any type of **process or sub-process relocation** including the outsourcing of processes or sub-processes to sub-suppliers: Mercedes-Benz AG shall be informed at least six months prior to the planned change
 - **Replacement/exchange of machinery, systems**, or other equipment: Mercedes-Benz AG shall be informed at least six months prior to the planned change
 - **Changing a sub-supplier** or manufacturer for subassemblies: Mercedes-Benz AG shall be informed at least six months prior to the planned change

3157958 In addition to the Quality Management department at the recipient plant, the supplier shall inform the following departments at Mercedes-Benz AG in the cases specified above: Development, Procurement, and Logistics (according to the currently valid MBST).

3157959 The documentation of changes shall be performed in coordination with the corresponding quality management department of the recipient plant.

3157960 The pending sampling and the necessary process acceptance procedures are to be coordinated with the responsible QM department in advance. The initiative shall be taken by the supplier.

2.1.25.2 Specific Production Process Requirements (3157961)

2.1.25.2.1 Requirements Pertaining to the Process Flow (3157962)

2.1.25.2.1.1 Implementation of the Procedure (3157963)

3157964 **Polishing:** For taillights with LED functions, the polishing working step shall be carried out before the End of Line Test or blowing off with ionized air or the use of ESD-compliant polishing disks is necessary.

3157965 **Assembly:** A process-consistent, perceptible and audible engagement of all connectors and adjustment elements internally and externally must be guaranteed in Assembly.

3157966 **Assembly:** Wiring harnesses must be designed and routed so that process-consistent and damage-free assembly is guaranteed. Tension on cable connections during assembly is not permissible.

3157968 **Assembly:** The tempering process must be carried out prior to the inline measurement.

3158004 **Assembly:** To achieve the required tolerances, a drilling/milling process shall be provided. Alternative subsequent processing processes shall be agreed on with Mercedes-Benz quality engineers.

<p>Mercedes-Benz - Confidential -</p>	<p><small>Schutzvermerk DIN ISO 16016 beachten! / Refer to protection notice DIN ISO 16016! Keine Aenderung ohne Zustimmung der federfuehrenden Konstruktion / Any alterations are subject to the approval of the design department</small></p> <p>Technical Component Requirement Specifications Tail lamp QEV 111 AJPNLG</p>	<p>Bearb./auth.: Hans Peter Schiffert Abt./dep.: RD/KEL Datum/date: 2022-07-25 Requirement Specifications 001 version: Seite/page: 141 of 220</p>
---	--	---

3158077 **Adhesive bonding:** For adhesive joints, the adhesive bonding process must be designed and verified while taking the specific adhesive bonding requirements into account (e.g. pre-treatment / press-on forces / times / tempering / pull-off forces, etc.)

2.1.25.2.1.2 Scrap and Rework (3158079)

3158081 **Assembly:** With reworked parts, repeat testing of all functions in the series production system shall be carried out to ensure the function.

3158083 **Assembly:** All reworked parts shall be clearly marked and/or documented, and traceability shall be ensured.

3158086 **Assembly:** Dismantled electronic components (LED boards, control units) shall be subjected to final testing prior to reutilization at the component manufacturer's plant or with an identical test according to the test specification.

3158088 **Assembly:** The supplier must create a concept for permissible reworking and coordinate it with the responsible quality department.

3158089 **Injection molding/assembly:** Rejects must be recorded and evaluated with the fault cause.

2.1.25.2.1.3 Testing Procedure, Testing Sequence, and Testing Frequency in the Process (3165793)

3166117 **High-gloss vapor deposition:** The process-accompanying test of the adhesion of high-gloss vapor depositions and protective coatings shall be carried out with a suitable examination workpiece in coordination with Mercedes (method open, e.g. caustic acid solution, cross cutting only for batch system). A correlation to the 48 h climatic chamber test must be ensured.

3166119 **Vapor deposition:** All parts shall be tested 100% for faults and color following surface coating.

3166120 **Assembly:** Prior to the process approval, of the assembly process, an ESD audit shall be carried out if relevant.

3166122 **Assembly:** All parts shall be subjected to a 100% visual inspection at the end of line. It may be necessary to specify higher inspection standards for the start-up with the quality contact person (e.g. dual control principle, second firewall, etc.).

3166123 **Assembly:** The screwing processes shall be verified automatically and process-consistently (e.g. number of screws, torque, tightening angle). Pneumatic screwdrivers are not permissible.

3166125 **Assembly:** 100% detection of completeness (Poka-Yoke, automatic inquiry, or reliable detection at following stations) shall be ensured.

3166126 **Assembly (Welding):** The welded joint shall be inspected through destructive testing and examination of the welding area for complete welds. The test shall be carried out at least 1x per shift and with a change in variants, if applicable, and shall be

<p>Mercedes-Benz - Confidential -</p>	<p style="font-size: small;">Schutzvermerk DIN ISO 16016 beachten! / Refer to protection notice DIN ISO 16016! Keine Aenderung ohne Zustimmung der federfuehrenden Konstruktion / Any alterations are subject to the approval of the design department</p> <p style="text-align: center;">Technical Component Requirement Specifications Tail lamp QEV 111 AJPNLG</p>	<p>Bearb./auth.: Hans Peter Schiffert Abt./dep.: RD/KEL Datum/date: 2022-07-25 Requirement Specifications 001 version: Seite/page: 142 of 220</p>
---	--	---

documented.

3166127

Assembly: To confirm the resistance to stress cracking, a test according to the currently valid function specification (section entitled "Ethanol Test – 4057036") shall be carried out on the annealed assembly or the annealed, welded shroud with a lens.

- For series production monitoring: 1x per shift test 1 (dip test).
- In the event of parameter changes in the process chain: Generally tests 1 and 2 (dip test and test in frame).

3166128

Assembly: An automated, process-consistent assignment of the country variant shall be ensured (e.g. camera system, laser method, ink jet printer, etc.). Additionally, all certification-relevant numbers and designations shall be checked for presence, completeness, and correctness in an automatic and process-consistent manner.

3166453

LED: The regular validation of the LED boards with a screening inspection shall be coordinated with RD/KEL (e.g. with heat and loading, taking into account the requirement from MBN 10447).

3166454

Fiber-optics test: Fiber optics shall be checked for surface defects (scratches, inclusions, damage, light color, etc.) while illuminated with the original light source. In addition, the light color shall be ensured in the ZB.

3166455

Annual requalification: The requalification plan shall be coordinated with RD and MP and presented by the start of PPAR.

2.1.25.2.1.4

Component Part Geometry (3166456)

3166457

The tolerance compliance of the ZB lamp shall be monitored by CMM measurement and inline measurement.

3166458

The measuring points (inline and CMM) shall be coordinated with Mercedes Benz AG prior to concept release.

3166459

Number of measuring points for inline measurement:

- Lights: Minimum number: 8 measuring points on the surface + 8 measuring points in the gap
- Continuous reflector strip: 12 measuring points on the surface + 12 measuring points in the gap

3166461

The results of the CMM measurement and the inline measurement shall be correlated. The target value of the correlation between the 3D measurement and inline is ± 0.1 mm. The verification shall also be submitted for the series supply release (PPAR).

2.1.25.2.1.4.1

Startup Phase (3166464)

3166465

In the start-up phase (confirmation vehicles and all production trials), the supplier shall carry out a 100% measurement (geometry) incl. measuring documentation.

3166466

In the event of failure to comply with the specified tolerance, a 100% measurement of

Mercedes-Benz - Confidential -	<small>Schutzvermerk DIN ISO 16016 beachten! / Refer to protection notice DIN ISO 16016! Keine Aenderung ohne Zustimmung der federfuehrenden Konstruktion / Any alterations are subject to the approval of the design department</small>	Bearb./auth.: Hans Peter Schiffert
	Technical Component Requirement Specifications Tail lamp QEV 111 AJPNLG	Abt./dep.: RD/KEL Datum/date: 2022-07-25 Requirement Specifications version: 001 Seite/page: 143 of 220

the geometry-determining component parts shall be carried out in addition to the analysis and ensuring process reliability.

3166467

A 100% CMM measurement can be waived for the production tests if the correlation between the inline/CMM measurements is successfully completed.

2.1.25.2.1.4.2 Series Production (3166468)

3166469

In series production, the supplier shall check and statistically evaluate the specified geometric measuring points "inline". The inline process monitoring represents a 100% inspection of all lamps during production.

3166470

In addition, at least one part shall be measured in comparison according to the measuring specification on the CMM during series production. The documentation shall be carried out graphically as a statistical assessment and shall be made available to the Quality department upon request.

3166471

Furthermore, the CMM measurement results shall be made available to the relevant Mercedes production plant as part of the purchased part dimensional audit

3166472

On the basis of the inline measurement results and the CMM measurement results, the process shall be regulated so that 100% tolerance compliance is ensured.

3166473

Not OK parts shall be sorted out.

2.1.25.2.1.4.3 Sampling (3166474)

3166475

Prior to the start of PPAR, the supplier shall prove using 50 sets of lamps (depending on the geometric variant) that the parts can be produced in a process-consistent manner within the tolerance:

- The variants are determined by the different geometries of the housing or the lens.
- In this context, all cavities/tools shall be equally taken into account and separately identified in the assessment.
- The lamps shall be manufactured in a series production process.
- The verification is done in a control chart including process parameters.

3166481

Contour and gap measuring points*: The process capability shall be verified by a **CP** ≥ 1.0.

3166482

Other measuring points*: The process capability shall be verified by a **CPK** ≥ 1.0.

<p>Mercedes-Benz - Confidential -</p>	<p style="font-size: small;">Schutzvermerk DIN ISO 16016 beachten! /Refer to protection notice DIN ISO 16016! Keine Aenderung ohne Zustimmung der federfuehrenden Konstruktion / Any alterations are subject to the approval of the design department</p> <p style="text-align: center;">Technical Component Requirement Specifications Tail lamp QEV 111 AJPNLG</p>	<p>Bearb./auth.: Hans Peter Schiffert Abt./dep.: RD/KEL Datum/date: 2022-07-25 Requirement Specifications 001 version: Seite/page: 144 of 220</p>
---	---	---

Herleitung Vorgaben für Prozessfähigkeit und Messhäufigkeit

Merkmal	Vorgabe KLH und Zeichnung bzgl. Prozessfähigkeit	Vorgabe Prozesslastenheft bzgl. Messhäufigkeit
Inline-Messpunkte	$cp \geq 1,0$	100%-Inline + 1x pro Schicht 3D-Vermessung
Weitere Messpunkte auf der Lichtscheibe (Umriss/Oberfläche)	$cp \geq 1,0$	Stichprobe: 1x pro Schicht 3D-Vermessung
Mindestspaltbegrenzer / Spacer	$Cpk \geq 1,0^*$	Stichprobe: 1x pro Schicht 3D-Vermessung <ul style="list-style-type: none"> • Händisch aufgeklebter Spacerpad als Mindestspaltbegrenzer: Vermessung mit/ohne Pad • Händisch aufgeklebter Spacerpad als RPS - Vermessung ohne Pad • Im Prozess verarbeiteter Spacerpad als RPS: Vermessung mit Pad
Z-Auflage Stoßfänger	$Cpk \geq 1,0^*$	Stichprobe: 1x pro Schicht 3D-Vermessung
Weitere Merkmale (z. B. Engstellen zum Rohbau)	$Cpk \geq 1,0^*$	Stichprobe: 1x pro Schicht 3D-Vermessung

Zeichnungseintragung:

Tolerierung: MBN 11012-1 (I)
 Allgemeintoleranz: MBN 11012-30_2

* Bei Nichterreichung erfolgt ein Review und eine neue Bewertung nach SOP + 6 Monate

2.1.25.2.1.5 Fulfillment of the Legal and MB-Specific Requirements Regarding Illumination Engineering (3166536)

2.1.25.2.1.5.1 Startup Phase (3166650)

3166678 In the start-up phase, in the time between off-tool parts and PPAR, the supplier shall carry out for each pre-production test batch a measurement of the entire photometric scope of testing using a goniophotometer for basic type/SA1/SA2 and send the test report to the relevant developer and quality engineer.

3166679 Addition, at the start of PPAR, a total of ten other measurement reports shall be generated for basic type/SA1/SA2 respectively, across all country variants (ECE left-hand traffic | ECE right-hand traffic | SAE), depending on the installation rate, in order to be able to make statements about process reliability.

2.1.25.2.1.5.2 Series Production Phase (3166680)

3166710 In series production, the supplier shall do a photometric measurement of 1x basic type, 1x SA1, and 1x SA2 each month for model series with a number of units exceeding 10,000 (testing of legal specifications). For model series with a number of units under 10,000 units per month, these measurements shall only be carried out every two months. Each country variant (ECE left-hand traffic | ECE right-hand traffic | SAE) shall be measured at least once every six months.

3167000 The photometric measurements include the entire scope of testing of the headlamp/rear lamp and shall be carried out with a goniophotometer (testing of legal

Mercedes-Benz - Confidential -	Schutzvermerk DIN ISO 16016 beachten! /Refer to protection notice DIN ISO 16016! Keine Aenderung ohne Zustimmung der federfuehrenden Konstruktion / Any alterations are subject to the approval of the design department	Bearb./auth.: Hans Peter Schiffert Abt./dep.: RD/KEL Datum/date: 2022-07-25
	Technical Component Requirement Specifications Tail lamp QEV 111 AJPNLG	Requirement Specifications 001 version: Seite/page: 145 of 220

specifications). Deviations from the specified measurement method shall be coordinated with MB development.



3167152

A summary of the measurement report results shall be sent monthly to the corresponding developer and quality engineer.

3167153

In this context, the following evaluation scale shall be used:

Bewertungsskala:

	grün (i.O.)	innerhalb der MB-spezifischen Toleranz
	gelb*	außerhalb der MB-spezifischen Toleranz / innerhalb der gesetzlichen Toleranz
	rot (n.i.O.)*	außerhalb der gesetzlichen Toleranz

*wenn gelb oder rot muss der entsprechende Messbericht beigelegt werden

3168510

An example of such an annual overview can be seen below:

Lieferant - Standort

BR	Jan-20	Feb-20	Mar-20	Apr-20	May-20	Jun-20	Jul-20	Aug-20	Sep-20
BR 1	12345678	638384056	45756868665	64739759065	243535434	24464686	25752245272	2752552272	
BR 2	23567888	3758696048	124546785*	534839744	343554325*	6325547	252475648*	25241135475*	
BR 3	54657868	456746788	34579021	343537242	35365657*	387571277*	487362261	272755757522	
BR 4**	24567897	x	64758935*	x	35827517*	x	61542757275*	x	
BR 5**	24458975	x	53647895	x	6245555	x	22457527	x	

* Messbericht muss beigelegt werden

** BR < 10.000 stk / Monat --> Messung nur alle 2 Monate notwendig

3168990

Bearbeitungshinweise:

Die Jahresübersicht muss für den entsprechenden Monat mit der zugehörigen Prüfberichtsnummer befüllt und der entsprechenden Farbe (siehe Bewertungsskala) bewertet werden.

3169066

If the results of these measurements show strong fluctuations or if the measurement results are outside of the MB-specific tolerance limit, additional weekly "minute measurements" regarding the critical light function shall be carried out and measures for process stabilization shall be implemented.

3169543

The brightness shall also be monitored during series production as part of the end-of-line test. The end-of-line test shall be verified 1x per shift with a "golden sample" (sample compared with a goniophotometer).

2.1.25.2.1.6

Cleanliness of the Component (3169665)

3169669

Vapor deposition/assembly/painting: Suitable protective agents and clothing (gloves, work clothing, belt protection, etc.) must be used to avoid damage and

Mercedes-Benz - Confidential -	<small>Schutzmerk DIN ISO 16016 beachten! /Refer to protection notice DIN ISO 16016! Keine Aenderung ohne Zustimmung der federfuehrenden Konstruktion / Any alterations are subject to the approval of the design department</small> Technical Component Requirement Specifications Tail lamp QEV 111 AJPNLG	Bearb./auth.: Hans Peter Schiffert Abt./dep.: RD/KEL Datum/date: 2022-07-25 Requirement Specifications version: 001 Seite/page: 146 of 220
---	--	--

dirt buildup).

- 3169802 Metalized components may only be touched with suitable gloves (for example, nitrile).
- 3169996 Gloves shall be replaced regularly.
- 3170069 To avoid dust and soiling on the component parts, a combination blow-extraction device shall be used.
- 3170138 Contamination because of the pallet / external reusable packing shall be excluded (suitable materials, regular cleaning). Verification of cleaning shall be attached on selected packaging.
- 3170206 Only clean, external reusable packaging shall be in production.
- 3170224 Internal pallets shall be kept clean to prevent contamination and damage of individual components (suitable materials, regular cleaning).
- 3170225 Electronic component parts with ESD relevance shall be packed only in ESD protective packaging.
- 3170239 Surface-sensitive component parts (scattering lenses, vapor-coated parts, LED modules, lenses, fiber optics, etc.) shall be transported in special in special packaging (no bulk cargo / general cargo).
- 3170327 Cleanliness: Depending on the component, measures shall be taken to avoid the ingress of dust and dirt. At minimum, the currently valid VDA Volume (technical cleanliness) shall be applied.

2.1.25.2.1.7 Storage, Material Flow, Continuous Production (3181279)

- 3181280 **Injection molding/assembly/handling:** Metalized parts or parts with a sensitive surface may only be touched with suitable gloves.
- 3181282 **Injection molding:** Injection-molded parts shall be set down and stored distortion-free and protected against dirt.
- 3181283 **Injection molding/assembly:** Tools, jigs and fixtures shall be protected against damage (storage, process, handling).
- 3181284 **Assembly:** Damage and dirt buildup of components in the assembly process and logistics process shall be avoided (padding, shape-dependent fixtures and trays).
- 3181285 **Assembly:** In the event of breaks, interruptions, and shift changes, each station shall end the work step and the following shift shall check it.
- 3181286 The transport, storage, and packaging provisions specified by the manufacturers and the law shall always be observed.

2.1.25.2.1.8 Machine Failure (3181287)

- 3181288 *In addition to the known specifications, there are no further specific requirements for the manufacturing process.*

Mercedes-Benz - Confidential -	<small>Schutzvermerk DIN ISO 16016 beachten! / Refer to protection notice DIN ISO 16016! Keine Aenderung ohne Zustimmung der federfuehrenden Konstruktion / Any alterations are subject to the approval of the design department</small>	Bearb./auth.: Hans Peter Schiffert
	Technical Component Requirement Specifications Tail lamp QEV 111 AJPNLG	Abt./dep.: RD/KEL Datum/date: 2022-07-25 Requirement Specifications 001 version: Seite/page: 147 of 220

3181289 Before resuming production following an interruption in production, all systems must be checked for operational readiness (e.g. heating up of tempering oven, retention time for granulate for fiber-optic cables in the injection-molding machine).

2.1.25.2.1.9 Identification and Traceability (3181290)

3181291 **Assembly:** The Q-status approved in the PIA system or the current state of development with the drawing geometry technical level (ZGS) shall be documented on the component label. Deviation only after coordination with the responsible quality areas.

3181292 **Injection molding:** Traceability of design statuses of the component parts shall be ensured.

3181293 **Test documentation:** The performance of 100% tests (leaktightness, function, inline measurement) shall be recognizable on the component part (e.g. center mark, connection to label printer, etc.). The type of marking shall be documented on the drawing.

3181294 **LED functions/electronic components:** The assignment and traceability of the LED modules and control units to the consecutive production number of the rear lamps shall be ensured (traceability).

2.1.25.2.2 Requirements Pertaining to Human Resources (3181295)

3181296 Backup solutions shall be devised for bottlenecks and turnovers related to personnel.

3181297 The availability of specialists shall be ensured.

3181298 The availability of a qualified "representative" of the supplier in the Mercedes-Benz AG target plant shall also be ensured (including for the null series).

2.1.25.2.3 Efficiency Requirements (3181299)

2.1.25.2.3.1 Process Parameters and Process Monitoring (3181300)

3181301 **Injection molding/vapor deposition/assembly:**

- The parameters shall be secured against unauthorized access.
- The responsibility for parameter changes shall be regulated and parameter changes shall be documented.
- Specified processing information from the raw materials manufacturer must be complied with (e.g. flash-off times, drying times, etc.)

2.1.25.2.3.2 Capability Investigation (3181302)

3181303 **Injection molding:** Verification of the process capability of the geometry-determining component parts shall be carried out (lens/housing).

<p>Mercedes-Benz - Confidential -</p>	<p style="font-size: small;">Schutzvermerk DIN ISO 16016 beachten! /Refer to protection notice DIN ISO 16016! Keine Aenderung ohne Zustimmung der federfuehrenden Konstruktion / Any alterations are subject to the approval of the design department</p> <p style="text-align: center;">Technical Component Requirement Specifications Tail lamp QEV 111 AJPNLG</p>	<p>Bearb./auth.: Hans Peter Schiffert Abt./dep.: RD/KEL Datum/date: 2022-07-25 Requirement Specifications 001 version: Seite/page: 148 of 220</p>
---	---	---

2.1.25.2.3.3 Performance Test (3181304)

4826996

Three binding performance tests shall be carried out over the project phases up to series production.

4826998

Der dreistufige Leistungstest in der Planungsphase, zum Anlauf und zur Kammlinienstückzahl

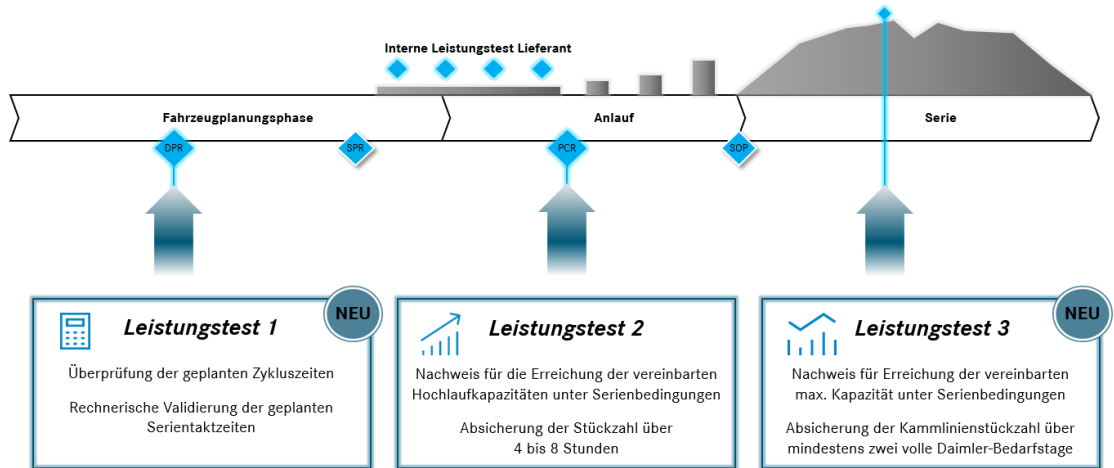

4827000

Bewertung der Stufen des Leistungstests

Leistungstesttyp	Erklärung	Finale Bewertungsmöglichkeit
Leistungstest 1 Überprüfung der Kapazitätsplanung	Auf Basis der rechnerischen Kapazitätsbewertung wird automatisch ein Ergebnis ermittelt (grün/rot). Die finale Bewertung kann „grün“ oder „rot“ sein. Grün: Planerische Taktzeit zur Sicherstellung der Kammlinienstückzahl erreicht Rot: Planerische Taktzeit zur Sicherstellung der Kammlinienstückzahl nicht erreicht	● ●
Leistungstest 2 Absicherung des Hochlaufs	Auf Basis des Produktionslaufs wird automatisch ein Ergebnis ermittelt (grün/rot). Die finale Bewertung kann „grün“, „gelb“ oder „rot“ sein. Grün: Bedarfe Kammlinienstückzahl abgedeckt Gelb: Bedarfe Kammlinienstückzahl nicht abgedeckt. Absicherung SOP und Hochlauf (teilweise) vorhanden, Maßnahmen zur Erreichung Kammlinienstückzahl definiert. Überprüfung der implementierten Maßnahmen notwendig, ggf. durch zusätzliche Leistungstest absichern. Weitere Leistungstest müssen so geplant werden, dass ein Engpass durch nicht vorhandene Kapazitäten vermieden wird. Rot: Bedarfe Kammlinienstückzahl nicht abgedeckt	● ● ●
Leistungstest 3 Absicherung der Kammlinie	Auf Basis des Produktionslaufs wird automatisch ein Ergebnis ermittelt (grün/rot). Die finale Bewertung kann „grün“ oder „rot“ sein. Grün: Bedarfe Kammlinienstückzahl erreicht Rot: Bedarfe Kammlinienstückzahl nicht erreicht	● ●

3181305

As part of the performance test, the actual production output is recorded for a defined component part scope, compared to the parameters "requirements" and "capacities", and assessed.

2.1.25.2.3.3.1 Performance Test Objectives (3181308)

3181306

The performance test objectives are:

- Validation of availability from supplier taking all general conditions and

Mercedes-Benz - Confidential -	Schutzvermerk DIN ISO 16016 beachten! /Refer to protection notice DIN ISO 16016! Keine Aenderung ohne Zustimmung der federführenden Konstruktion / Any alterations are subject to the approval of the design department	Bearb./auth.: Hans Peter Schiffert Abt./dep.: RD/KEL Datum/date: 2022-07-25 Requirement Specifications 001 version: Seite/page: 149 of 220
	Technical Component Requirement Specifications Tail lamp QEV 111 AJPNLG	

influencing parameters into consideration.

- Assessment of process performance and quality capability for complete production process under series-production conditions (tools, systems, cycle time, personnel at production location...)
- Check of ability to use the resources to produce the required quantity on time to meet customer requirements

2.1.25.2.3.3.2 Internal Performance Test by the Supplier (3181309)

3181307 As part of the pre-production test batch manufacturing of the null series, the progress of process performance shall be verified by an internal performance test.

3181310 The target/current cycle times shall be indicated (overall and station-related), elaboration of bottleneck.

2.1.25.2.3.3.3 Evaluation of the Performance Test Results (3181311)

3181312 The following minimum specifications apply for the performance test approach curve:

3181313 **For new product projects (NPP) with respect to full capacity production:**

- 50% to PPA report
- 70% to PRO1
- 90% to PRO2
- 100% to PRO3 and green

3181314 **For facelift with respect to full capacity production:**

- 70% to PPA report
- 90% to PRO1
- 100% to PRO2 (#1)

4827001 The results from the performance test are included in the sampling results (Appendix "Verification of Series Cycle Time" – Requirement from VDA Volume 2).

2.1.25.2.4 Machine Requirements (3181318)

2.1.25.2.4.1 Special Requirements Pertaining to the System (3181319)

3181320 **LED function:** A process-consistent optical function inquiry shall be carried out for each individual LED.

3181321 **LED function:** A process-consistent color recognition for variants or assignment shall be carried out (e.g. ECE/SAE).

Mercedes-Benz - Confidential -	<small>Schutzvermerk DIN ISO 16016 beachten! / Refer to protection notice DIN ISO 16016! Keine Änderung ohne Zustimmung der federführenden Konstruktion / Any alterations are subject to the approval of the design department</small>	Bearb./auth.: Hans Peter Schiffert
	Technical Component Requirement Specifications Tail lamp QEV 111 AJPNLG	Abt./dep.: RD/KEL Datum/date: 2022-07-25 Requirement Specifications version: 001 Seite/page: 150 of 220

2.1.25.2.4.2 Manufacturing Plant and Facilities (3181322)

- 3181323 **Assembly:** For ESD-relevant component parts, effective ESD-protection with access regulation shall be ensured.
- 3181324 **Test stations:** Test stations shall be standard-compliant (VDA 16) and sufficiently illuminated.

2.1.25.2.4.3 Test Equipment and Calibration (3181325)

- 3181326 The supplier shall verify that the parts supplied are dimensionally accurate according to the customer's specifications. Therefore to ensure the process reliability, component part test equipment and test equipment for the assembly (ZB test equipment) shall be created. The concept for the test equipment for single parts shall be adapted to the ZB test equipment (identical, consistent concept). The mounting concept and the inspection characteristics for the ZB test equipment shall be coordinated with Mercedes-Benz (same concepts at supplier's plant and at Mercedes-Benz).
- 3181327 The test equipment capability must be demonstrated for the PPAR, however at the latest for the Pro1. A correlation between an inline measurement/dial gauge and the CMM test equipment (see Chapter "Testing Procedure, Testing Sequence, and Testing Frequency in the Process") shall be demonstrated and monitored on a regular basis.
- 3181328 In justified cases, Mercedes-Benz AG will optionally provide additional analysis test equipment in addition to the supplier's mandatory process test equipment. If the supplier is provided with this optional analysis test equipment, then the supplier is obligated to determine the test equipment capability. If this is negative, Mercedes-Benz Test Equipment Planning and the quality engineer shall be informed immediately.
- 3181329 **Injection molding:** Component part gages for parts that determine the geometry shall be produced by the supplier (lenses, housings), incl. the verification of the test equipment capability.
- 3181330 **Assembly:** Suitable calibration parts for monitoring the geometry, function, leaktightness, and final test shall be produced and kept in stock. The test frequencies shall be agreed on with Mercedes and documented in the inspection plan.

2.1.25.2.4.4 Maintenance (3181332)

- 3181333 Systems, jigs, fixtures and tools shall be serviced and cleaned on a regular basis. Planning and execution must be documented. A plan for emergencies and critical replacement parts shall be available.
- 3181334 An emergency plan shall be submitted to Mercedes no later than VDA 6.3 Part 3 / process acceptance.
- 3181335 A back up shall be created for software / testing software / process parameters /

<p>Mercedes-Benz - Confidential -</p>	<p><small>Schutzvermerk DIN ISO 16016 beachten! /Refer to protection notice DIN ISO 16016! Keine Aenderung ohne Zustimmung der federfuehrenden Konstruktion / Any alterations are subject to the approval of the design department</small></p> <p>Technical Component Requirement Specifications Tail lamp QEV 111 AJPNLG</p>	<p>Bearb./auth.: Hans Peter Schiffert Abt./dep.: RD/KEL Datum/date: 2022-07-25 Requirement Specifications 001 version: Seite/page: 151 of 220</p>
---	--	---

documentation / etc.

2.1.25.2.4.5 Supports, Tooling, and Cleaning Agents (3181336)

3181337

Assembly: Only approved and tested auxiliary materials and operating fluids may be used (greases, cleaning agents, adhesives). The handling specifications and process times specified by the manufacturer shall be observed.

2.2 Service Life and Reliability (STM-869019)

2.2.1 Reliability Validation in the Product Creation Process (STM-869028)

STM-869035
STLH-5466B

The verification of reliability required in the following in the form of the Bx minimum verification limit of the component relates to all types of failure. In addition to the minimum verification limit, the confidence level (C) to be used for verifying the required reliability is also specified.

STM-869037
STLH-5468A

For example, B5=100,000 km means that of 100 units that have operated for 100,000 km, 95 are still in working order and 5 have reached the end of their service life.

STM-869034
STLH-5641

If there are safety-relevant properties of the component covered here, the quality-oriented minimum verification limit for reliability defined here shall be supplemented by a separate validation of the safety-relevant aspects, which absolutely corresponds to the state of the art. The steps required for this are not a part of the quality-oriented reliability verification.

STM-869036
STLH-5602C

The following minimum verification limit applies in particular to the product creation phase. The minimum verification limit for reliability does not replace the agreements valid in the series production delivery phase on delivery quality (see CRQ-273), field quality (see CRQ-275) and replacement part quality (see CRQ-277). The minimum verification limit does not replace or subtract from the requirements pertaining to safety or ASIL classifications as per ISO 26262 or other standards. This minimum verification limit can be used to determine the minimum scope of testing required to obtain a statistically valid verification of reliability.

STM-869038
STLH-5469A

Minimum verification limit for reliability in the development phase			For information only at 100,000 km
Beta shape parameter up to 100,000 km	Failure probability x [%] at 12 MIS (months in service)	Confidence level C[%]	Failure probability x[%]
Beta = 1	When used in: diesel engine: 0.3 gasoline engine: 0.2 transmission: 0.13	90	When used in: diesel engine: approx. 1.4 gasoline engine: approx. 1.3 transmission: approx. 0.65

Mercedes-Benz - Confidential -	<small>Schutzvermerk DIN ISO 16016 beachten! /Refer to protection notice DIN ISO 16016! Keine Aenderung ohne Zustimmung der federfuehrenden Konstruktion / Any alterations are subject to the approval of the design department</small> Technical Component Requirement Specifications Tail lamp QEV 111 AJPNLG	Bearb./auth.: Hans Peter Schiffert Abt./dep.: RD/KEL Datum/date: 2022-07-25 Requirement Specifications 001 version: Seite/page: 152 of 220

STM-2100400
STLH-7590

The contractor confirms with its testing that the real failure probability undershoots the failure probability defined as the minimum verification limit for reliability. A procedure for the verification can be obtained from the VDA (CRQ-3013).

2.2.2 E/E Components (STM-869090)

2.2.2.1 Service Life of E/E Components (STM-869091)

2.2.2.1.1 Component-Specific Service Life Specification (STM-1207583)

STM-869098
STLH-5657

Service life in the field: 15 years

STM-869097
STLH-5658A

Time in driving operating mode: 9000.0 hours

STM-869099
STLH-5662

Duration of off-grid parking operating mode: 131400.0 hours

STM-869101
STLH-5663

Mileage over service life: 300000 km

STM-869103
STLH-5664

The cited time durations are maximum values that require validation. Since consideration must also be given to customers who drive extremely little (charging, preconditioning, on-grid parking), the off-grid parking time is always assumed to be the full number of hours for the defined service life.

2.2.2.2 Mission Profile (STM-869105)

STM-869106
STLH-6603

The following mission profile describes environmental influences and stresses that act upon the component at its installation location in the vehicle. During component development, the contractor shall take these environmental influences and stresses into consideration and derive the necessary consequences.

2.2.2.2.1 Climatic Condition (STM-869107)

2.2.2.2.1.1 Operating Mode: Driving (STM-869104)

2.2.2.2.1.1.1 Ambient Temperature of Component at Installation Location (STM-869108)

STM-869110
STLH-4745C

Temperature distribution profile 1 as per Annex B of [IMBN 10306](#)

Temperature/distribution

-40 °C / 6%

23 °C / 20%

40 °C / 65%

Mercedes-Benz - Confidential -	<small>Schutzvermerk DIN ISO 16016 beachten! /Refer to protection notice DIN ISO 16016! Keine Aenderung ohne Zustimmung der federfuehrenden Konstruktion / Any alterations are subject to the approval of the design department</small>	Bearb./auth.: Hans Peter Schiffert
	Technical Component Requirement Specifications Tail lamp QEV 111 AJPNLG	Abt./dep.: RD/KEL Datum/date: 2022-07-25 Requirement Specifications 001 version: Seite/page: 153 of 220

75 °C / 8%
80 °C / 1%

Temperature delta: average 36 K

2.2.2.2.1.1.2 Number of Changes in Temperature (STM-869115)

STM-869117
STLH-5671
10950.0 temperature cycles over 15 years

2.2.2.2.1.1.3 Humidity (STM-869122)

STM-1207587
STLH-5961A
Relative humidity up to 100%, condensation and icing

2.2.2.2.1.2 Operating Mode: Off-Grid Parking (STM-869157)

2.2.2.2.1.2.1 Ambient Temperature of Component at Installation Location (STM-869154)

STM-869156
STLH-5707
Minimum temperature: -40.0 °C

STM-869163
STLH-5708
Maximum temperature: 80.0 °C

STM-869160
STLH-5709
Typical temperature: 23 °C

2.2.2.2.1.2.2 Humidity (STM-1207952)

STM-869164
STLH-5715
Average 65 % relative humidity

STM-869165
STLH-4750A
Relative humidity up to 100%, condensation and icing

2.2.2.2.2 Protection against the Ingress of Solid Foreign Objects (Including Dust) (STM-869166)

STM-869176
STLH-4780C
Protection against ingress of dust in accordance with the requirement in Chapter 5, Table 2 of [ISO 20653](#) – degree of protection [IP 6KX](#)
There shall be no ingress of dust into the component.

2.2.2.2.3 Protection against the Ingress of Water/Fluids (STM-869174)

STM-869180
STLH-4788B
Protection against high-pressure water jets in accordance with Chapter 6 of [ISO 20653](#) degree of protection [IP X6K](#)
Water that is directed against the housing from any direction as a strong jet with increased pressure shall not have any harmful effects or impair performance.

STM-869184
The requirement pertaining to protection against the ingress of water applies

Mercedes-Benz - Confidential -	<small>Schutzvermerk DIN ISO 16016 beachten! /Refer to protection notice DIN ISO 16016! Keine Aenderung ohne Zustimmung der federfuehrenden Konstruktion / Any alterations are subject to the approval of the design department</small>	Bearb./auth.: Hans Peter Schiffert
	Technical Component Requirement Specifications Tail lamp QEV 111 AJPNLG	Abt./dep.: RD/KEL Datum/date: 2022-07-25 Requirement Specifications version: 001 Seite/page: 154 of 220

STLH-6604 throughout the entire vehicle service life.

STM-869187
STLH-6605 The component is exposed to water primarily when the vehicle is being driven.

2.2.2.3 Environmental Testing for E/E Components (STM-869192)

2.2.2.3.1 General Test Parameters (STM-869189)

STM-869190
STLH-4793C *Some general test parameters are specified in the following list (see also [\[MBN 10306\]](#))*

2.2.2.3.1.1 Test Parameter T_{min} (STM-1208014)

STM-869196
STLH-4796 Value: -40.0 °C

STM-869193
STLH-4794A *Meaning: Minimum operating temperature.*

2.2.2.3.1.2 Test Parameter T_{RT} (STM-1208031)

STM-869195
STLH-4797A Value: (23 ±5) °C

STM-1208032
STLH-7252 *Meaning: Room temperature*

2.2.2.3.1.3 Test Parameter T_{max} (STM-1208068)

STM-869194
STLH-4803 Value: 80.0 °C

STM-869197
STLH-4798A *Meaning: Maximum operating temperature.*

2.2.2.3.1.4 Test Parameter $T_{op,min}$ (STM-1208099)

STM-869200
STLH-4806 Value: -40.0 °C

STM-869198
STLH-4804A *Meaning: Minimum operating temperature for components with overload protection/low-temperature protection.*

2.2.2.3.1.5 Test Parameter $T_{op,max}$ (STM-1208187)

STM-869199
STLH-4812 Value: 80.0 °C

STM-869201
STLH-4807B *Meaning: Maximum operating temperature for components with overload protection/overtemperature protection.*

Mercedes-Benz - Confidential -	<small>Schutzvermerk DIN ISO 16016 beachten! /Refer to protection notice DIN ISO 16016! Keine Aenderung ohne Zustimmung der federfuehrenden Konstruktion / Any alterations are subject to the approval of the design department</small>	Bearb./auth.: Hans Peter Schiffert
	Technical Component Requirement Specifications Tail lamp QEV 111 AJPNLG	Abt./dep.: RD/KEL Datum/date: 2022-07-25 Requirement Specifications version: 001 Seite/page: 155 of 220

2.2.2.3.1.6 Test Parameter U_{Bmin} (STM-1209128)

STM-869218
STLH-4814 Value: 8.0 V

STM-869214
STLH-4813A *Meaning: Lower operating voltage limit*

2.2.2.3.1.7 Test parameter U_B (STM-1212412)

STM-869222
STLH-4816 Value: 12.8 V

STM-869217
STLH-4815A *Meaning: Operating voltage*

2.2.2.3.1.8 Test Parameter U_{Bmax} (STM-1212415)

STM-869220
STLH-4818 Value: 17.0 V

STM-869221
STLH-4817B *Meaning: Upper operating voltage limit*

2.2.2.3.2 Operating Modes (STM-869228)

STM-869231
STLH-4820C During their service life, the electrical, electronic and mechatronic components and systems will be operated in various operating modes, and these shall be appropriately simulated in the tests. Details of the operating modes, operating loads (e.g. control signals, original sensors, original actuator or replacement circuits) and the necessary boundary conditions shall be agreed between the client and contractor and documented.

STM-869233
STLH-4821 To this end, the contractor shall define all relevant parameters for the operating modes described below, including, for example, supply voltages, input signals and bus messages, and do so in a time-dependent manner, where applicable, to include tolerance specifications. The contractor shall coordinate these parameters with the client and shall document them in the technical specifications or in the component test specifications.

2.2.2.3.2.1 Operating Modes without Operating Load – The DUT is Not Connected to Electricity (STM-869230)

2.2.2.3.2.1.1 Operating Mode: Unplugged (STM-869229)

STM-869232
STLH-6613 The DUT is not electrically connected, without plug and wiring harness.

2.2.2.3.2.1.2 Operating Mode: Vehicle Assembly (STM-869234)

STM-869235 The DUT is not electrically connected, but with connected plugs and wiring harness.

Mercedes-Benz - Confidential -	<small>Schutzvermerk DIN ISO 16016 beachten! / Refer to protection notice DIN ISO 16016! Keine Aenderung ohne Zustimmung der federfuehrenden Konstruktion / Any alterations are subject to the approval of the design department</small>	Bearb./auth.: Hans Peter Schiffert
	Technical Component Requirement Specifications Tail lamp QEV 111 AJPNLG	Abt./dep.: RD/KEL Datum/date: 2022-07-25 Requirement Specifications version: 001 Seite/page: 156 of 220

2.2.2.3.2.2 Operating Modes with Operating Load – The DUT is Connected to Electricity (STM-869236)

2.2.2.3.2.2.1 Operating Modes with a Low Operating Load (STM-869241)

STM-869239
STLH-6620

For the Driving, Charging, Preconditioning, On-Grid Parking and Off-Grid Parking working conditions, the operating mode with low operating load is designated as Driving_{min}, Charging_{min}, Preconditioning_{min}, On-Grid Parking_{min}, Off-Grid Parking_{min}. The DUT shall be operated with the lowest operating load that is realistically possible in the given operating mode.

The power supply of all charge states relevant to the component (12 V on-board electrical system, 48 V on-board electrical system, HVAC and HVDC) and, where applicable, the bus activity, shall be simulated in accordance with the real situation in the vehicle for the given operating mode.

From these operating modes with low operating load, Driving_{min}, Charging_{min}, Preconditioning_{min}, On-Grid Parking_{min} and Off-Grid Parking_{min}, the operating mode shall be identified in which the component generates the least power dissipation. This will in the following be called Operation_{min}.

STM-869243
STLH-6621

The operating modes of Driving_{min}, Charging_{min}, Preconditioning_{min}, On-Grid Parking_{min}, Off-Grid Parking_{min} and Operation_{min} shall be defined for the component in detail by the contractor, coordinated with the client and documented in the technical specifications (supplier) or in the component's test specification.

2.2.2.3.2.2.2 Operating Modes with a High Operating Load (STM-869242)

STM-869245
STLH-6624

For the Driving, Charging, Preconditioning, On-Grid Parking and Off-Grid Parking operating modes, the operating mode with high operating load is designated as Driving_{max}, Charging_{max}, Preconditioning_{max}, On-Grid Parking_{max}, Off-Grid Parking_{max}. The DUT shall be operated with high operating load as per design load profile (e.g. power user, 95% customer, but no misuse).

The DUT shall here be operated such that maximum power dissipation is generated (e.g. through a realistic maximization of a continuous output power or through frequent activation of external loads).

The power supply of all charge states relevant to the component (12 V on-board electrical system, 48 V on-board electrical system, HVAC and HVDC) and, where applicable, the bus activity, shall be simulated in accordance with the real situation in the vehicle for the given operating mode.

From these operating modes with high operating load, Driving_{max}, Charging_{max}, Preconditioning_{max}, On-Grid Parking_{max} and Off-Grid Parking_{max}, the operating mode shall be identified in which the component generates the greatest power dissipation. This will in the following be called Operation_{max}.

If there are several operating modes with high operating load in which the component generates significant power dissipation or demonstrates special functionalities, the component shall be operated intermittently in these operating modes, with consideration given to all of the functionalities in the relevant operating modes.

<p>Mercedes-Benz - Confidential -</p>	<p><small>Schutzvermerk DIN ISO 16016 beachten! / Refer to protection notice DIN ISO 16016! Keine Aenderung ohne Zustimmung der federfuehrenden Konstruktion / Any alterations are subject to the approval of the design department</small></p> <p>Technical Component Requirement Specifications Tail lamp QEV 111 AJPNLG</p>	<p>Bearb./auth.: Hans Peter Schiffert Abt./dep.: RD/KEL Datum/date: 2022-07-25 Requirement Specifications 001 version: Seite/page: 157 of 220</p>
--	---	---

STM-869244
STLH-6625

The operating modes of Driving_{max}, Charging_{max}, Preconditioning_{max}, On-Grid Parking_{max}, Off-Grid Parking_{max} and Operation_{max} shall be defined for the component in detail by the contractor, coordinated with the client and documented in the technical specifications (supplier) or in the component's test specification.

2.2.2.3.3 Parameter Test and Parameter Monitoring (STM-869248)

2.2.2.3.3.1 Parameter Test (STM-869247)

STM-869252
STLH-4836C

In order to systematically and reproducibly assess the DUTs, a set of sensitive parameters (so-called "key parameters") shall be defined specifically for each component. These are, for example, no-load current consumption, operating currents, output voltages, transition resistances, input impedances, signal rates (rise and fall times) and bus specifications.

STM-869249
STLH-4837A

The component-specific key parameters, including their specification limits, shall be proposed by the contractor, coordinated with the client and documented.

STM-869253
STLH-6627

The parameter test shall be carried out immediately upon completion of the previously performed test.
The time between the end of the previously performed test and the performance of the parameter check shall be documented in the test report.

2.2.2.3.3.1.1 P-01 Parameter Test (Function Test) (STM-869250)

STM-869251
STLH-4844B

The key parameters shall be measured at one specified temperature and at each of the voltage levels U_{Bmin} , U_B and U_{Bmax} . For components with HV supply, this parameter test shall be carried out at U_{Bmin} with $U_{Bmin,HV}$, at U_B with $U_{B,HV}$ and at U_{Bmax} with $U_{Bmax,HV}$.

The basic functionalities of the DUTs shall be measured. For components with fault memory, the content of the fault memory shall be read out.

2.2.2.3.3.1.2 P-02 Parameter Test (Minor) (STM-869254)

STM-869255
STLH-4840B

The key parameters shall be measured and the functional behavior of the DUTs checked at T_{RT} and U_B .

For components with fault memory, the content of the fault memory shall be read out.

For components connected to a coolant circuit, this parameter test shall be carried out at T_{RT} with $T_{cool,nom}$.

For components with a [HV](#) power supply, this parameter test shall be performed at U_B with $U_{B,HV}$.

In addition, the DUTs shall be checked for external damage/changes such as cracks, chipping/peeling, discoloration, deformation etc. by visual inspection according to DIN EN 13018 and without opening the DUTs.

All results shall be documented in the test report.

<p>Mercedes-Benz - Confidential -</p>	<p style="font-size: small;">Schutzvermerk DIN ISO 16016 beachten! / Refer to protection notice DIN ISO 16016! Keine Aenderung ohne Zustimmung der federfuehrenden Konstruktion / Any alterations are subject to the approval of the design department</p> <p style="text-align: center;">Technical Component Requirement Specifications Tail lamp QEV 111 AJPNLG</p>	<p>Bearb./auth.: Hans Peter Schiffert Abt./dep.: RD/KEL Datum/date: 2022-07-25 Requirement Specifications 001 version: Seite/page: 158 of 220</p>
--	--	---

2.2.2.3.3.1.3 P-03 Parameter Test (Major) (STM-869258)

STM-869256
STLH-4842C

The key parameters shall be measured and the functional behavior of the components measured at temperatures T_{max} , T_{RT} and T_{min} at each of the voltages U_{Bmin} , U_B and U_{Bmax} . In addition, a leak test shall be performed at T_{RT} in accordance with Chapter "Leak Test" of [\[MBN 10306\]](#).

For components with fault memory, the content of the fault memory shall be read out. For components connected to a coolant circuit, this parameter test shall be performed at T_{RT} with $T_{cool,nom}$, at T_{max} with $T_{cool,max}$ and at T_{min} with $T_{cool,min}$.

For components with HV supply, this parameter test shall be carried out at U_{Bmin} with $U_{Bmin,HV}$, at U_B with $U_{B,HV}$ and at U_{Bmax} with $U_{Bmax,HV}$.

In addition, the DUTs shall be checked for external damage/changes such as cracks, chipping/peeling, discoloration, deformation, etc. by visual inspection in accordance with DIN EN 13018 and without opening the DUTs.

The DUTs shall be manually shaken to check for loose internal parts.

All results shall be documented in the test report.

2.2.2.3.3.2 Continuous Parameter Monitoring with Drift Analysis (STM-869257)

STM-869263
STLH-4846C

The contractor shall define a set of sensitive parameters to be continuously monitored during testing, for example by means of computer-controlled measurement data acquisition. In so doing, the required sampling rates and measurement value resolutions shall be adjusted to the signal change rate of each evaluation criterion and shall be selected such as to detect functional deviations. For components with fault memory, the fault memory shall be monitored continuously and all entries shall be documented.

The data acquired from continuous parameter monitoring shall be examined for trends and drifts. Any irregularities, aging effects or malfunctions identified here shall be documented and evaluated in the test report.

2.2.2.3.3.3 Sampling Rates and Measured Value Resolutions (STM-869260)

STM-869259
STLH-5745

The sampling rate and bandwidth of the measuring system shall be adapted to the respective test.

It shall be ensured that functionally relevant peaks (temporary positive/negative deviation) are detected and recorded.

The resolution of the measured values shall be adapted to the respective test.

2.2.2.3.3.4 Leak Test (STM-869261)

STM-869262
STLH-6630

A leak test is used to verify adherence to the limit leak rate for a component's electronics compartment that was specifically defined for the component.

The air leak rate of the DUT shall be determined by applying the usual measuring methods (e.g. for absolute pressure, pressure differential, mass flow or volumetric flow rate).

STM-869264
STLH-6631

To this end, a defined test pressure is applied to the component through an access point (e.g. DAE); after a settling time, the air leak rate is measured by technical means.

<p>Mercedes-Benz - Confidential -</p>	<p style="font-size: small;">Schutzvermerk DIN ISO 16016 beachten! / Refer to protection notice DIN ISO 16016! Keine Aenderung ohne Zustimmung der federfuehrenden Konstruktion / Any alterations are subject to the approval of the design department</p> <p style="text-align: center;">Technical Component Requirement Specifications Tail lamp QEV 111 AJPNLG</p>	<p>Bearb./auth.: Hans Peter Schiffert Abt./dep.: RD/KEL Datum/date: 2022-07-25 Requirement Specifications 001 version: Seite/page: 159 of 220</p>
--	--	---

STM-869267
STLH-6632

Component-specific limit leak rate: 3 cm³/min at 0.5 bar_{rel}

STM-869268
STLH-6635

Since the design and the application determine the amount of pressure a medium exerts on the component in the field, the test pressure shall be selected such that it corresponds to the toughest use case in the field. This may even be a vacuum. If it can be assumed that the sealing system behaves differently when exposed to positive or negative pressure (e.g. pressing of sealing lips), then the test shall be performed with both positive and negative pressure. The test pressure to be applied (typically 0.5 bar_{rel}) shall be agreed between contractor and client and then documented.

STM-869273
STLH-6636

The leak test shall be conducted as part of the P-03 Parameter Test (Large) at T_{RT}. During the measurement, the DUT shall not be subjected to any fluctuations in temperature. The measured air leak rate shall not exceed the limit leak rate specifically defined for the component and shall be documented in the test report. Changes in the air leak rate shall be evaluated and documented in the test report.

2.2.2.3.3.5 Physical Analysis (STM-869269)

STM-869271
STLH-6637A

The inspection methods required for the physical analysis in accordance with Annex G of [\[MBN 10306\]](#) shall be agreed upon between the client and contractor and documented.

All DUTs shall be opened and subjected to a visual inspection in accordance with [\[DIN EN 13018\]](#).

If a DUT demonstrates irregularities, the additional analysis shall be agreed with the client, if appropriate by adding additional DUTs or using additional analytical methods. The results shall be documented and evaluated in the test report.

2.2.2.3.4 Tests (STM-869270)

STM-869272
STLH-4850B

The following environmental tests specify a minimum scope of testing, the results of which are required for the client's release decision. They serve to verify the component's basic suitability for automotive use. This minimum scope of testing, however, does not relieve the contractor of the obligation to develop and validate the component with its mission profile in mind and such that it will reliably withstand the stresses experienced in the field without experiencing faults or errors.

STM-869274
STLH-4851D

The details described in the other applicable document [\[MBN 10306\]](#) shall be taken into account during the execution of the tests.

STM-869276
STLH-4852

If the present component requirement specifications describe several variants of a component, the following tests shall be carried out for each variant using the number of DUTs required for each. Deviations from this requirement shall be agreed between contractor and client prior to contract award and documented in the tender.

STM-869278
STLH-4853

The tests shall be executed in the chronological sequence specified in the "Test Sequence Plan" chapter.

STM-869275
STLH-4854B

The standards cited in the following tests are referenced as normative references in [\[MBN 10306\]](#).

<p>Mercedes-Benz - Confidential -</p>	<p><small>Schutzvermerk DIN ISO 16016 beachten! / Refer to protection notice DIN ISO 16016! Keine Aenderung ohne Zustimmung der federfuehrenden Konstruktion / Any alterations are subject to the approval of the design department</small></p> <p>Technical Component Requirement Specifications Tail lamp QEV 111 AJPNLG</p>	<p>Bearb./auth.: Hans Peter Schiffert Abt./dep.: RD/KEL Datum/date: 2022-07-25 Requirement Specifications 001 version: Seite/page: 160 of 220</p>
--	---	---

2.2.2.3.4.1 M-03 Dust Test (STM-869308)

2.2.2.3.4.1.1 Test (STM-869309)

STM-869311
STLH-4886C

The test shall be carried out in accordance with Chapter "M-03 Dust Test" of [\[MBN 10306\]](#) with the following parameters:

STM-869312
STLH-4887A

Operating mode of DUT:
For electrical/electronic components: Operation_{min}

STM-869313
STLH-4889

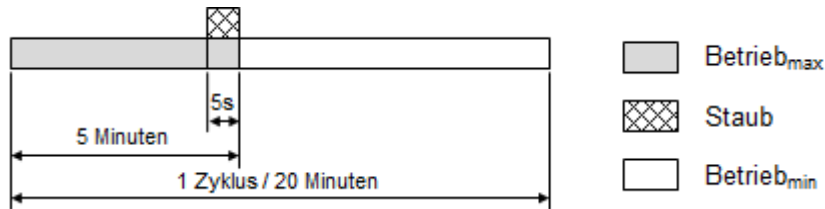

Figure: Test sequence for dust test

STM-869316
STLH-4890

Protection class to be achieved: [IP 6K X](#)

STM-869315
STLH-4891

Number of DUTs: 6

STM-869317
STLH-4892A

Note: When performing the test, the installation position of the component in the vehicle shall be simulated. The test setup (installation position, covers, trim, situation during operation) shall be recommended by the contractor, coordinated with the client, and documented.

2.2.2.3.4.1.2 Requirement (STM-869314)

STM-869318
STLH-4894A

The required protection class as per [\[ISO 20653\]](#) shall be achieved.

STM-869323
STLH-4895D

The DUT shall be fully functional before, during and after the test and all parameters shall meet the specifications. Verification is provided via a P-02 parameter test (small) as per the Chapter "Parameter Test" of [\[MBN 10306\]](#).

STM-869321
STLH-4896A

In addition, the DUT shall be visually inspected with the naked eye.

STM-869320
STLH-4897

Changes/damage shall be documented in the test report and evaluated with the client.

Mercedes-Benz - Confidential -	<small>Schutzvermerk DIN ISO 16016 beachten! /Refer to protection notice DIN ISO 16016! Keine Aenderung ohne Zustimmung der federfuehrenden Konstruktion / Any alterations are subject to the approval of the design department</small>	Bearb./auth.: Hans Peter Schiffert Abt./dep.: RD/KEL Datum/date: 2022-07-25 Requirement Specifications version: 001 Seite/page: 161 of 220
	Technical Component Requirement Specifications Tail lamp QEV 111 AJPNLG	

2.2.2.3.4.2 M-04 Vibration Test (STM-869319)

2.2.2.3.4.2.1 Vibration Profile D (for Components Mounted on Sprung Masses (Body)) (STM-869390)

2.2.2.3.4.2.1.1 Test (STM-869391)

STM-869397
STLH-4962C

The test shall be performed in accordance with Chapter "M-04 Vibration Test" of the [\[MBN 10306\]](#) with the following parameters:

STM-869394
STLH-4963B

Operating mode of DUT: Intermittent Driving_{min} and Driving_{max} (see following figure)

STM-869396
STLH-4964

Superimposed temperature profile: Repeating as per the following figure

STM-869395
STLH-4965A

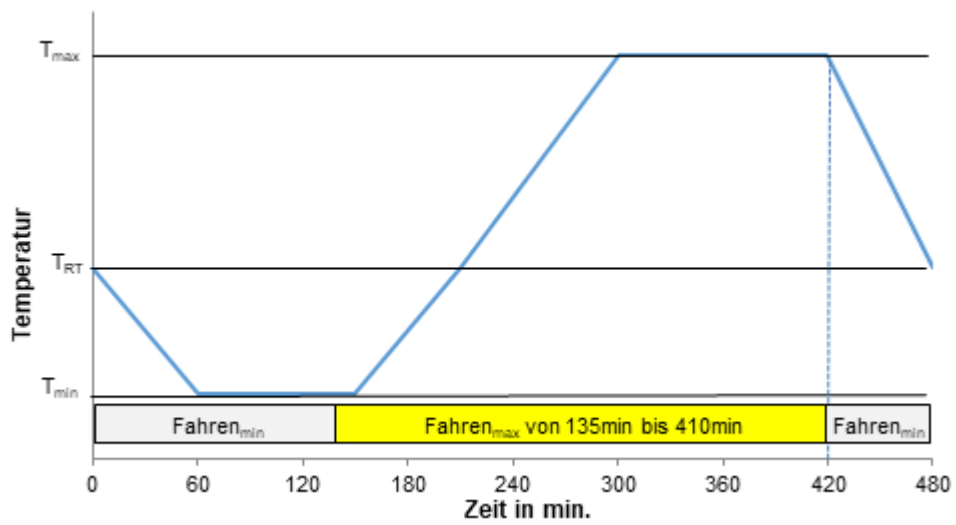

Figure: Temperature profile – Vibration

STM-869398
STLH-4966

Number of DUTs: 6

2.2.2.3.4.2.1.2 Vibration Profile (STM-869399)

STM-869400
STLH-4968

Vibration excitation: Broadband random vibration

STM-869402
STLH-4969A

Test duration for each dimensional axis: 8 h

STM-869403
STLH-4970A

Acceleration rms value: 31.3 m/s²

STM-869401
STLH-4971B

Vibration profile:

Frequency (Hz)	Power spectral density ((m/s ²) ² /Hz)
5	0.884
10	30

Mercedes-Benz - Confidential -	<small>Schutzvermerk DIN ISO 16016 beachten! / Refer to protection notice DIN ISO 16016! Keine Änderung ohne Zustimmung der federführenden Konstruktion / Any alterations are subject to the approval of the design department</small>	Bearb./auth.: Hans Peter Schiffert Abt./dep.: RD/KEL Datum/date: 2022-07-25
	Technical Component Requirement Specifications Tail lamp QEV 111 AJPNLG	Requirement Specifications 001 version: Seite/page: 162 of 220

400 / 0.2
2,000 / 0.2

STM-869404
STLH-4972A

The test shall be carried out without brackets or attached parts. The mounting of connected lines (e.g. electric lines, coolant hoses, hydraulic lines, etc.) in the test setup shall be defined.

STM-869405
STLH-4973

Any additional tests that include brackets/attached parts shall be coordinated with the client as required.

STM-869406
STLH-4974

The sampling rate shall be selected such that open circuits and short circuits will be detected with absolute certainty.

2.2.2.3.4.2.1.3 Requirement (STM-869408)

STM-869411
STLH-4976D

The DUT shall be fully functional before, during and after the test and all parameters shall meet the specifications. Verification is provided via continuous parameter monitoring and a P-03 parameter test (large) as per the Chapter "Parameter Test" of [\[MBN 10306\]](#).

STM-869413
STLH-6641

In addition, the DUT shall be evaluated visually with the naked eye and shaken to check for loose or rattling parts.

2.2.2.3.4.3 M-05 Mechanical Shock (STM-869429)

2.2.2.3.4.3.1 Test (STM-869431)

STM-869432
STLH-4996C

The test shall be carried out in accordance with Chapter "M-05 Mechanical Shock" of [\[MBN 10306\]](#) with the following parameters:

STM-869433
STLH-4997B

Operating mode of DUT:
Driving_{max}

STM-869437
STLH-4998

Peak acceleration: 500 m/s²

STM-869438
STLH-4999

Duration of pulse: 6 ms

STM-869434
STLH-5000

Shape of pulse: Half-sine

STM-869435
STLH-5001

Number of shocks per direction ($\pm X$, $\pm Y$, $\pm Z$): 10

STM-869436
STLH-5002

Number of DUTs: 6

2.2.2.3.4.3.2 Requirement (STM-869443)

STM-869440
STLH-5004C

The DUT shall be fully functional before, during and after the test and all parameters shall meet the specifications. Verification is provided via continuous parameter monitoring and a P-02 parameter test (small) as per the Chapter "Parameter Test" of [\[MBN 10306\]](#)

Mercedes-Benz - Confidential -	<small>Schutzvermerk DIN ISO 16016 beachten! / Refer to protection notice DIN ISO 16016! Keine Aenderung ohne Zustimmung der federfuehrenden Konstruktion / Any alterations are subject to the approval of the design department</small>	Bearb./auth.: Hans Peter Schiffert
	Technical Component Requirement Specifications Tail lamp QEV 111 AJPNLG	Abt./dep.: RD/KEL Datum/date: 2022-07-25 Requirement Specifications version: 001 Seite/page: 163 of 220

STM-869439
STLH-6643

In addition, the DUT shall be evaluated visually with the naked eye and shaken to check for loose or rattling parts.

2.2.2.3.4.4 M-06 Mechanical Shock Endurance (STM-869441)

2.2.2.3.4.4.1 Test (STM-869442)

STM-869446
STLH-5007C

The test shall be carried out in accordance with Chapter "M-06 Mechanical Shock Endurance" of [\[MBN 10306\]](#) with the following parameters:

STM-869445
STLH-5008A

Operating mode of DUT: Driving_{max}

STM-869447
STLH-5009

Peak acceleration: 300 m/s²

STM-869444
STLH-5010

Duration of pulse: 6 ms

STM-869448
STLH-5011

Shape of pulse: Half-sine

STM-869450
STLH-5014B

Number of shocks: 30,000
(installation area: trunk lid/liftgate)

STM-869453
STLH-5016

Installation position: Installation of the DUT on the test facility shall correspond to the installation situation in the vehicle.

STM-869454
STLH-5017A

Number of DUTs: 6

2.2.2.3.4.4.2 Requirement (STM-869457)

STM-869456
STLH-5019C

The DUT shall be fully functional before, during and after the test and all parameters shall meet the specifications. Verification is provided via continuous parameter monitoring and a P-02 parameter test (small) as per the Chapter "Parameter Test" of [\[MBN 10306\]](#).

STM-869455
STLH-6644

In addition, the DUT shall be evaluated visually with the naked eye and shaken to check for loose or rattling parts.

2.2.2.3.4.5 K-01 High/Low Temperature Storage (STM-869466)

2.2.2.3.4.5.1 Test (STM-869467)

STM-869472
STLH-5022C

The test shall be carried out in accordance with Chapter "K-01 High/Low Temperature Storage" of [\[MBN 10306\]](#) with the following parameters:

STM-869471
STLH-5023A

Operating mode of DUT: Uninstalled

STM-869469
STLH-5024

Test duration and test temperature: 2 cycles of 24 h (consisting of 12 h storage at T_{min} and 12 h storage at T_{max})

Mercedes-Benz - Confidential -	<small>Schutzvermerk DIN ISO 16016 beachten! / Refer to protection notice DIN ISO 16016! Keine Aenderung ohne Zustimmung der federfuehrenden Konstruktion / Any alterations are subject to the approval of the design department</small>	Bearb./auth.: Hans Peter Schiffert
	Technical Component Requirement Specifications Tail lamp QEV 111 AJPNLG	Abt./dep.: RD/KEL Datum/date: 2022-07-25 Requirement Specifications version: 001 Seite/page: 164 of 220

STM-869470
STLH-5025A

Number of DUTs: See Test Sequence Plan

2.2.2.3.4.5.2 Requirement (STM-869473)

STM-869477
STLH-5027C

The DUT shall be fully functional before and after the test and all parameters shall meet the specifications. The verification is provided via a P-03 parameter test (large) as per the Chapter "Parameter test" of [\[MBN 10306\]](#).

STM-869475
STLH-6654

In addition, the DUT shall be evaluated visually with the naked eye and shaken to check for loose or rattling parts.

2.2.2.3.4.6 K-02 Multi-Stage Temperature Test (STM-869476)

2.2.2.3.4.6.1 Test (STM-869474)

STM-869478
STLH-5030C

The test shall be performed in accordance with Chapter "K-02 Temperature Step Test" of [\[MBN 10306\]](#) with the following parameters:

STM-869480
STLH-5031C

Operating mode of DUT: During the P-01 parameter test (function test) Operation_{max}, otherwise Operation_{min}

STM-869482
STLH-5032A

Test temperature: The DUTs shall be subjected to the temperature profile shown in the following figure. Temperature change of 5 °C per step.

STM-869481
STLH-5033D

Test sequence: The DUT shall be kept at each temperature step until complete thermal equilibrium is attained (see Chapter "Attainment of Complete Thermal Equilibrium" in [\[MBN 10306\]](#)).

This shall be followed by a P-01 parameter test (function test) as per Chapter "Parameter Test" in [\[MBN 10306\]](#).

At the key temperatures T_{min} , T_{RT} and T_{max} , as well as for liquid-cooled components at the temperatures $T_{cool,min}$, T_{RT} and $T_{cool,max}$, the P-01 parameter test (function test) shall be performed at the three voltages U_{Bmin} , U_B and U_{Bmax} analogous to the P-03 parameter test (large).

<p>Mercedes-Benz - Confidential -</p>	<p style="font-size: small;">Schutzvermerk DIN ISO 16016 beachten! / Refer to protection notice DIN ISO 16016! Keine Aenderung ohne Zustimmung der federfuehrenden Konstruktion / Any alterations are subject to the approval of the design department</p> <p style="text-align: center;">Technical Component Requirement Specifications Tail lamp</p> <p style="text-align: center;">QEV 111 AJPNLG</p>	<p>Bearb./auth.: Hans Peter Schiffert Abt./dep.: RD/KEL Datum/date: 2022-07-25 Requirement Specifications 001 version: Seite/page: 165 of 220</p>
---	--	---

STM-869479
STLH-5034B

Number of DUTs: See Test Sequence Plan

STM-869483
STLH-5035B

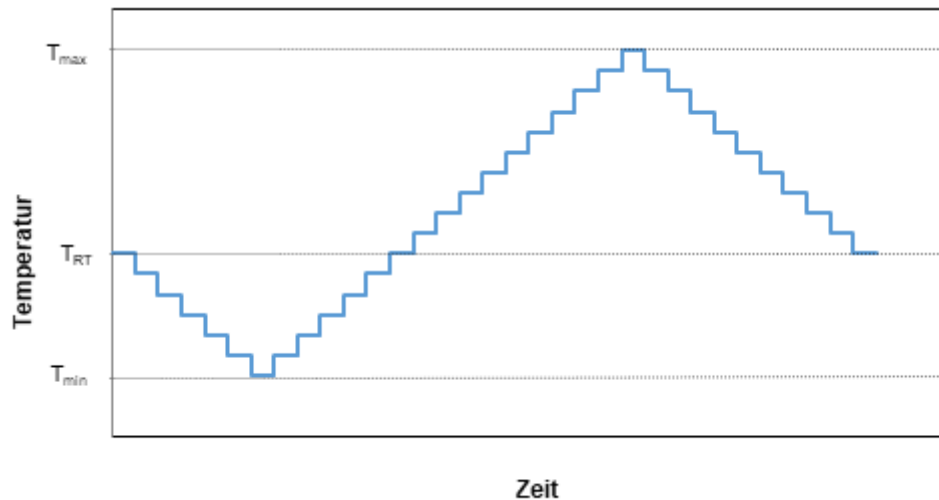

Figure: Temperature profile – Temperature step test

2.2.2.3.4.6.2 Requirement (STM-869484)

STM-869485
STLH-5037A

All parameters of the DUT shall lie within the specification during each P-01 parameter test (function test).

2.2.2.3.4.7 K-03 Low-Temperature Operation (STM-869488)

2.2.2.3.4.7.1 Test (STM-869487)

STM-869491
STLH-5040C

The test shall be carried out in accordance with Chapter "K-03 Low temperature operation" of [\[MBN 10306\]](#) with the following parameters:

STM-869489
STLH-5041B

Operating mode of DUT:
 12 h off-grid parking_{min} (for terminal 30 components at U_{Bmin})
 12 h operation_{max} at U_{Bmin}
 12 h off-grid parking_{min} (for terminal 30 components at U_B)
 12 h operation_{max} at U_B

STM-869490
STLH-5042

Test duration: 48 h

STM-869492
STLH-5043

Test temperature: T_{min}

STM-869493
STLH-5754A

For components with high power dissipation a rise of the test chamber temperature due to self-heating above T_{min} is allowed for this test in operating mode Operation_{max} if agreed between contractor and client.

STM-869498
STLH-5044

Number of DUTs: 6

<p>Mercedes-Benz - Confidential -</p>	<p style="font-size: small;">Schutzvermerk DIN ISO 16016 beachten! / Refer to protection notice DIN ISO 16016! Keine Aenderung ohne Zustimmung der federfuehrenden Konstruktion / Any alterations are subject to the approval of the design department</p> <p style="text-align: center;">Technical Component Requirement Specifications Tail lamp QEV 111 AJPNLG</p>	<p>Bearb./auth.: Hans Peter Schiffert Abt./dep.: RD/KEL Datum/date: 2022-07-25 Requirement Specifications 001 version: Seite/page: 166 of 220</p>
--	--	--

2.2.2.3.4.7.2 Requirement (STM-869494)

STM-869495
STLH-5046C

The DUT shall be fully functional before, during and after the test and all parameters shall meet the specifications. Verification is provided via continuous parameter monitoring and a P-02 parameter test (small) as per the Chapter "Parameter Test" of [\[MBN 10306\]](#).

2.2.2.3.4.8 K-05 Thermal Shock (Component) (STM-869507)

2.2.2.3.4.8.1 Test (Air-Air, as per [\[DIN EN 60068-2-14\]](#) Na) (STM-869506)

STM-869513
STLH-5057C

The test shall be applied in accordance with Chapter "K-05 Thermal shock (component)" of [\[MBN 10306\]](#) with the following parameters:

STM-869509
STLH-5058A

Operating mode of DUT: Vehicle assembly

STM-869510
STLH-5059

Lower temperature: T_{min}

STM-869511
STLH-5060

Upper temperature: T_{max}

STM-869512
STLH-5061C

Holding time at upper/lower temperature: 15 min following attainment of complete thermal equilibrium (see Chapter "Attainment of complete thermal equilibrium" of [\[MBN 10306\]](#))

STM-869515
STLH-5062

Transition time: ≤ 30 s

STM-869518
STLH-5063A

Test: As per [\[DIN EN 60068-2-14\]](#) Na

STM-869517
STLH-5064

Number of cycles: 100

STM-869514
STLH-5065

Number of DUTs: 6

2.2.2.3.4.8.1.1 Requirement (STM-869516)

STM-869521
STLH-5067C

The DUT shall be fully functional before and after the test and all parameters shall meet the specifications. The verification is provided via a P-03 parameter test (large) as per the Chapter "Parameter test" of [\[MBN 10306\]](#).

2.2.2.3.4.9 K-06 Salt Spray Test, Operating, Exterior (STM-869537)

2.2.2.3.4.9.1 Test (STM-869534)

STM-869538
STLH-5084C

The test shall be performed in accordance with Chapter "K-06 Salt Spray Testing, Operating, Exterior" of [\[MBN 10306\]](#) with the following parameters:

STM-869535

Operating mode of DUT:

Mercedes-Benz - Confidential -	<small>Schutzvermerk DIN ISO 16016 beachten! /Refer to protection notice DIN ISO 16016! Keine Aenderung ohne Zustimmung der federfuehrenden Konstruktion / Any alterations are subject to the approval of the design department</small>	Bearb./auth.: Hans Peter Schiffert
	Technical Component Requirement Specifications Tail lamp QEV 111 AJPNLG	Abt./dep.: RD/KEL Datum/date: 2022-07-25 Requirement Specifications 001 version: Seite/page: 167 of 220

STLH-5085A During spray phase: Intermittent 1 h Off-Grid Parking_{min} and 1 h Operation_{max}.
During rest phase: Off-Grid Parking_{min}

STM-869536
STLH-5086 Test temperature: 35 °C

STM-869540
STLH-5087 Test cycle: Each test cycle consists of an 8 h spray phase and a 4 h rest phase as per the following figure.

STM-869542
STLH-5088A Number of test cycles: 12 cycles

STM-869543
STLH-5090 Number of DUTs: 6

STM-869541
STLH-5091 When performing the test, the installation position of the component in the vehicle shall be simulated.

STM-869547
STLH-5092B

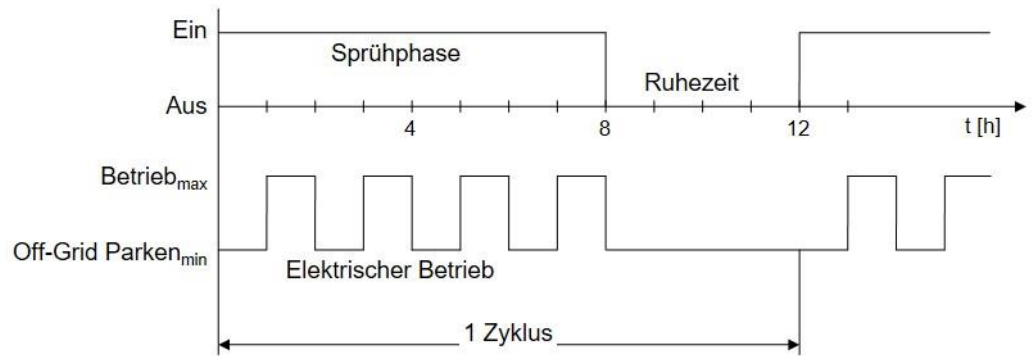

Figure: Salt spray test, operating, exterior – Spray phases

2.2.2.3.4.9.2 Requirement (STM-869544)

STM-869548
STLH-5094C The DUT shall be fully functional before, during and after the test and all parameters shall meet the specifications. Verification is provided via continuous parameter monitoring and a P-02 parameter test (small) as per the Chapter "Parameter Test" of [\[MBN 10306\]](#).

2.2.2.3.4.10 K-08 Damp Heat, Cyclic (STM-869562)

2.2.2.3.4.10.1 Test (STM-869561)

STM-869560
STLH-5109C The test shall be carried out in accordance with Chapter "K-08 Damp Heat, Cyclic" of [\[MBN 10306\]](#) with the following parameters:

STM-869563
STLH-5110A Operating mode of DUT:
During the P-01 parameter test (function test) Operation_{max}, otherwise Operation_{min}

STM-869564
STLH-5111A Total test duration: 144 h

STM-869567
STLH-5112 Test variant: Variant 1

Mercedes-Benz - Confidential -	<small>Schutzvermerk DIN ISO 16016 beachten! /Refer to protection notice DIN ISO 16016! Keine Änderung ohne Zustimmung der federführenden Konstruktion / Any alterations are subject to the approval of the design department</small>	Bearb./auth.: Hans Peter Schiffert Abt./dep.: RD/KEL Datum/date: 2022-07-25 Requirement Specifications version: 001 Seite/page: 168 of 220
	Technical Component Requirement Specifications Tail lamp QEV 111 AJPNLG	

STM-869566
STLH-5113 Upper test temperature: 55 °C

STM-869568
STLH-6655 A P-01 parameter test (function test) shall be carried out on reaching the upper as well as the lower test temperature.

STM-869570
STLH-6656 When performing the test, the installation position of the component in the vehicle shall be simulated.

STM-869569
STLH-5114 Number of cycles: 6

STM-869571
STLH-5115 Number of DUTs: 6

2.2.2.3.4.10.2 Requirement (STM-869572)

STM-869573
STLH-5117C The DUT shall be fully functional before, during and after the test and all parameters shall meet the specifications. Verification is provided via continuous parameter monitoring and a P-03 parameter test (large) as per the Chapter "Parameter Test" of [\[MBN 10306\]](#).

2.2.2.3.4.11 K-09 Damp Heat, Cyclic (with Frost) (STM-869574)

2.2.2.3.4.11.1 Test (STM-869577)

STM-869575
STLH-5121C The test shall be performed in accordance with Chapter "K-09 Damp Heat, Cyclic (with Frost)" of [\[MBN 10306\]](#) with the following parameters:

STM-869576
STLH-5122B Operating mode of DUT: Intermittent 40 min Operation_{min} and 10 min Operation_{max}.

For components with extremely high self-heating, the contractor shall consult with the client as to whether the duration in the Operation_{max} operating mode should be shortened to the duration that is required for checking the overall functionality of the component. The cycle duration of 50 minutes shall be maintained in this case.

STM-869578
STLH-5123A Total test duration: 240 h

STM-869583
STLH-6657 When performing the test, the installation position of the component in the vehicle shall be simulated.

STM-869580
STLH-5124 Number of test cycles: 10

STM-869581
STLH-5125 Test cycle sequence: The first five cycles shall include a cold subcycle and the remaining cycles shall be carried out without a cold subcycle.

STM-869582
STLH-5126 Number of DUTs: 6

2.2.2.3.4.11.2 Requirement (STM-869584)

STM-869587 The DUT shall be fully functional before, during and after the test and all parameters

<p>Mercedes-Benz - Confidential -</p>	<p><small>Schutzvermerk DIN ISO 16016 beachten! /Refer to protection notice DIN ISO 16016! Keine Aenderung ohne Zustimmung der federfuehrenden Konstruktion / Any alterations are subject to the approval of the design department</small></p> <p>Technical Component Requirement Specifications Tail lamp QEV 111 AJPNLG</p>	<p>Bearb./auth.: Hans Peter Schiffert Abt./dep.: RD/KEL Datum/date: 2022-07-25 Requirement Specifications 001 version: Seite/page: 169 of 220</p>
---	--	---

STLH-5128C shall meet the specifications. Verification is provided via continuous parameter monitoring and a P-03 parameter test (large) as per the Chapter "Parameter Test" of [\[MBN 10306\]](#).

2.2.2.3.4.12 K-10 Water Protection - IPX0 to IPX6K (STM-869585)

2.2.2.3.4.12.1 Test (STM-869588)

STM-869586
STLH-5131C The test shall be performed in accordance with Chapter "K-10 Water Protection - IPX0 to IPX6K" of [\[MBN 10306\]](#) with the following parameters:

STM-869591
STLH-5132A Operating mode of DUT: Intermittent 1 min Operation_{min} and 1 min Operation_{max}.

STM-869589
STLH-5133 Required protection class: [IP](#) X6k

STM-869592
STLH-6658 When performing the test, the installation position of the component in the vehicle shall be simulated.

STM-869590
STLH-5134 Number of DUTs: 6

2.2.2.3.4.12.2 Requirement (STM-869593)

STM-869596
STLH-5136A The required protection class as per [\[ISO 20653\]](#) shall be achieved.

STM-869595
STLH-5137A There shall be no water ingress into the component. The DUT shall not be opened until completion of the entire test sequence.

STM-869597
STLH-5138C The DUT shall be fully functional before, during and after the test and all parameters shall meet the specifications. Verification is provided via continuous parameter monitoring and a P-02 parameter test (small) as per the Chapter "Parameter Test" of [\[MBN 10306\]](#)

2.2.2.3.4.13 K-14 Damp Heat, Steady State (STM-869647)

2.2.2.3.4.13.1 Test (STM-869649)

STM-869652
STLH-5188C The test shall be performed in accordance with Chapter "K-14 Damp heat, steady state" of [\[MBN 10306\]](#) with the following parameters:

2.2.2.3.4.13.2 Standard Test Sequence (STM-869651)

STM-869650
STLH-5190B Operating mode of DUT: Intermittent operation between 47 h Off-Grid Parking_{min} and 1 h Operation_{max}, repeated until the end of the test duration.

If the On-Grid Parking operating mode is relevant for the component, testing shall be done using the operating mode On-Grid Parking_{min} instead of Off-Grid Parking_{min}.

STM-869653 Test duration: 1,596.0 h

Mercedes-Benz - Confidential -	<small>Schutzvermerk DIN ISO 16016 beachten! /Refer to protection notice DIN ISO 16016! Keine Aenderung ohne Zustimmung der federfuehrenden Konstruktion / Any alterations are subject to the approval of the design department</small>	Bearb./auth.: Hans Peter Schiffert Abt./dep.: RD/KEL Datum/date: 2022-07-25 Requirement Specifications 001 version: Seite/page: 170 of 220
	Technical Component Requirement Specifications Tail lamp QEV 111 AJPNLG	

STLH-5191

STM-869655
STLH-5192

Test temperature: 65 °C

STM-869657
STLH-5193

Test humidity: 93 % relative humidity

STM-869654
STLH-5194

Number of DUTs: 6

STM-869658
STLH-5195A

Prior to the execution of this service life test, a check shall be conducted to ascertain whether the high test acceleration using the test parameters of 65 °C and 93 % r.h. exceeds the physical limits of the materials used in the component (e.g. hydrolysis of plastics). Where applicable, the contractor and client shall agree to changes in the test temperature and test humidity (e.g. to 55 °C and 93 % relative humidity) while increasing the test duration as per the Lawson model such that the physical limits of the materials used are not exceeded during the test. The overall severity of the testing shall, however, remain unchanged. The test humidity shall not exceed the level of 93 % relative humidity.

STM-869662
STLH-5196A

It shall be ensured that no condensation (including local condensation) occurs on the DUT during the test.

2.2.2.3.4.13.3 Requirement (STM-869669)

STM-869672
STLH-5207C

The DUT shall be fully functional before, during and after the test and all parameters shall meet the specifications. Verification is provided via continuous parameter monitoring and a P-03 parameter test (large) as per the Chapter "Parameter Test" of [\[MBN 10306\]](#).

2.2.2.3.4.14 K-16 Thermal Shock (without Shroud) (STM-869717)

2.2.2.3.4.14.1 Test (STM-869718)

STM-869720
STLH-5232C

The test shall be carried out in accordance with Chapter "K-16 Thermal Shock (without Housing)" of [\[MBN 10306\]](#) with the following parameters:

STM-869719
STLH-5233A

Operating mode of DUT: Uninstalled

STM-869722
STLH-5234

Lower temperature: T_{min}

STM-869721
STLH-5235

Upper temperature: T_{max}

STM-869723
STLH-5236C

Holding time at upper and lower temperature: 15 min following attainment of complete thermal equilibrium (see Chapter "Attainment of complete thermal equilibrium" of Annex A of [\[MBN 10306\]](#))

STM-869727
STLH-5237

Transition time: ≤ 10 s

STM-869724
STLH-5238A

Number of cycles: 300

Mercedes-Benz - Confidential -	<small>Schutzvermerk DIN ISO 16016 beachten! /Refer to protection notice DIN ISO 16016! Keine Aenderung ohne Zustimmung der federfuehrenden Konstruktion / Any alterations are subject to the approval of the design department</small>	Bearb./auth.: Hans Peter Schiffert Abt./dep.: RD/KEL Datum/date: 2022-07-25 Requirement Specifications version: 001 Seite/page: 171 of 220
	Technical Component Requirement Specifications Tail lamp QEV 111 AJPNLG	

STM-869726
STLH-5239

Number of DUTs: 6 electronic assemblies

2.2.2.3.4.14.2 Requirement (STM-869725)

STM-869728
STLH-5241C

The DUT shall be fully functional before and after the test and all parameters shall meet the specifications. The verification is provided via a P-03 parameter test (large) as per the Chapter "Parameter test" of [\[MBN 10306\]](#).

2.2.2.3.4.15 K-18 Corrosion Test with Flow of Mixed Gas (STM-869743)

2.2.2.3.4.15.1 Test (STM-869744)

STM-869747
STLH-5257C

The test shall be carried out in accordance with Chapter "K-18 Corrosion Test with Flow of Mixed Gas" of [\[MBN 10306\]](#) with the following parameters:

STM-869745
STLH-5258A

Operating mode of DUT: Vehicle assembly

STM-869746
STLH-5259

Temperature: T_{RT}

STM-869748
STLH-5260

Humidity: 75 %

STM-869753
STLH-5261

Pollutant gas concentration:
Sulfur dioxide SO₂: 0.2 ppm
Hydrogen sulfide H₂S: 0.01 ppm
Nitrogen dioxide NO₂: 0.2 ppm
Chlorine Cl₂: 0.01 ppm

STM-869749
STLH-5262

Test duration: 21 days

STM-869752
STLH-5263

Number of DUTs: 6

2.2.2.3.4.15.2 Requirement (STM-869750)

STM-869751
STLH-5265B

The DUT shall be fully functional before and after the test and all parameters shall meet the specifications. Verification is provided via a P-03 parameter test (large) as per the Chapter 5.5 of Annex A of [\[MBN 10306\]](#).

STM-869756
STLH-5266

In addition, the contact resistance of switches and contacts shall be measured. The measured values shall meet the specifications.

2.2.2.3.4.16 L-02 Life Test: High-Temperature Endurance Test (STM-869823)

STM-869820
STLH-5330C

The test shall be performed in accordance with Chapter "L-02 Life test: High-temperature endurance test" of [\[MBN 10306\]](#) with the following parameters:

Mercedes-Benz - Confidential -	<small>Schutzvermerk DIN ISO 16016 beachten! / Refer to protection notice DIN ISO 16016! Keine Aenderung ohne Zustimmung der federfuehrenden Konstruktion / Any alterations are subject to the approval of the design department</small>	Bearb./auth.: Hans Peter Schiffert
	Technical Component Requirement Specifications Tail lamp QEV 111 AJPNLG	Abt./dep.: RD/KEL Datum/date: 2022-07-25 Requirement Specifications 001 version: Seite/page: 172 of 220

2.2.2.3.4.16.1 Test Sequence for Components Not Connected to a Coolant Circuit and without Reduced Performance at High Temperatures (STM-869822)

STM-869824
STLH-5332B
Operating mode of DUT: Intermittent 47 h Operation_{max} and 1 h Off-Grid Parking_{min}. In the Operation_{max} operating mode, the component shall be operated intermittently in all relevant operating modes with high operating load. The shares of time spent in these operating modes shall correspond to the respective share of the total test duration.

STM-869828
STLH-5333B
Total test duration: 1662.0 h

The total test duration is the sum of the following partial test durations:

STM-869827
STLH-5791A
Partial test duration and test temperature for mapping the Driving working condition:

(Partial test duration/test temperature)
1662.0 h/80.0 °C

STM-869836
STLH-5335
Number of DUTs: 6

2.2.2.3.4.16.2 Requirement (STM-869879)

STM-869880
STLH-5345
The DUT shall be fully functional before, during and after the test and all key parameters shall meet the specifications. Verification shall be provided using continuous parameter monitoring. Intermediate measurements at 25 %, 50 % and 75 % of the test duration and parameter tests as per the test sequence plan shall only be carried out if the functions of the component cannot be sufficiently monitored during the test.

STM-869881
STLH-5346C
The intermediate measurements shall be performed as a P-03 parameter test (large) as per the Chapter "Parameter Test" of [\[MBN 10306\]](#).

STM-869883
STLH-5347
The data acquired from continuous parameter monitoring shall be assessed for drifts, trends and conspicuous behavior or anomalies.

2.2.2.3.4.17 L-03 Life Test: Temperature Cycle Endurance Test (STM-869887)

STM-869884
STLH-5350C
The test shall be carried out in accordance with Chapter "L-03 Life Test: Temperature Cycle Endurance Test" of [\[MBN 10306\]](#) with the following parameters:

2.2.2.3.4.17.1 Test Sequence for Components Not Connected to the Coolant Circuit and without Reduced Performance at Low or High Temperatures (STM-869886)

STM-869893
STLH-5352A
Operating mode of DUT: Intermittent Operation_{max} and Off-Grid Parking_{min} as per the following figure.

STM-869889
Temperature profile: As per the following figure.

<p>Mercedes-Benz - Confidential -</p>	<p><small>Schutzvermerk DIN ISO 16016 beachten! /Refer to protection notice DIN ISO 16016! Keine Aenderung ohne Zustimmung der federfuehrenden Konstruktion / Any alterations are subject to the approval of the design department</small></p> <p>Technical Component Requirement Specifications Tail lamp QEV 111 AJPNLG</p>	<p>Bearb./auth.: Hans Peter Schiffert Abt./dep.: RD/KEL Datum/date: 2022-07-25 Requirement Specifications 001 version: Seite/page: 173 of 220</p>
--	--	---

STLH-5353

STM-869890
STLH-5356

Temperature gradient: 4 °C/min
If the temperature gradient cannot be realized in the test equipment, it can be reduced to a minimum of 2 °C/min in coordination with the client.

STM-869892
STLH-5820B

Holding times at T_{min} , T_{max} , $T_{op,min}$ and $T_{op,max}$: 15 min following attainment of complete thermal equilibrium (see Chapter "Attainment of Complete Thermal Equilibrium" in [\[MBN 10306\]](#))

STM-869891
STLH-5358B

Total number of test cycles: 540.0
The total number of cycles consists of the following partial numbers of cycles:

STM-869898
STLH-5823A

Partial number of cycles for mapping the "driving" operating mode:

Number of test cycles: 540.0

T_{min} : -40.0 °C

T_{max} : 80.0 °C

STM-869903
STLH-5359

Number of DUTs: 6

STM-869906
STLH-5360A

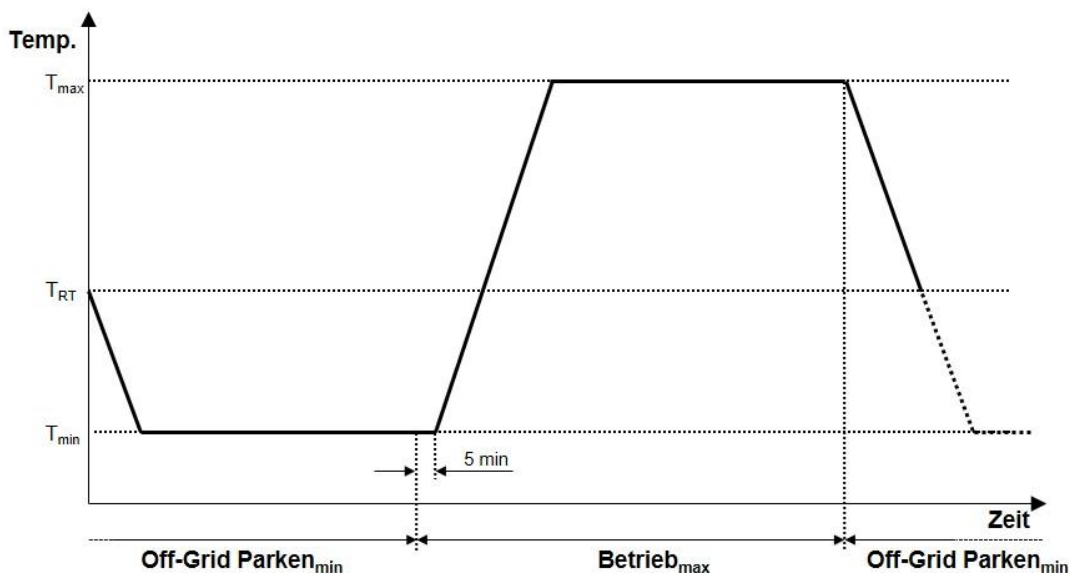

Figure: Temperature profile L-03 Life test: Temperature cycle endurance test for components not connected to the coolant circuit and without reduced performance at low or high temperatures

2.2.2.3.4.17.2 Requirement (STM-869944)

STM-869945
STLH-5372

The DUT shall be fully functional before, during and after the test and all key parameters shall meet the specifications. Verification shall be provided using continuous parameter monitoring. Intermediate measurements at 25 %, 50 % and 75 % of the test duration and parameter tests as per the test sequence plan shall only be carried out if the functions of the component cannot be sufficiently monitored during

Mercedes-Benz - Confidential -	<small>Schutzvermerk DIN ISO 16016 beachten! / Refer to protection notice DIN ISO 16016! Keine Aenderung ohne Zustimmung der federfuehrenden Konstruktion / Any alterations are subject to the approval of the design department</small>	Bearb./auth.: Hans Peter Schiffert Abt./dep.: RD/KEL Datum/date: 2022-07-25 Requirement Specifications version: 001 Seite/page: 174 of 220
	Technical Component Requirement Specifications Tail lamp QEV 111 AJPNLG	

the test.

STM-869947
STLH-5373C

The intermediate measurements shall be performed as a P-03 parameter test (large) as per the Chapter "Parameter Test" of [\[MBN 10306\]](#).

STM-869946
STLH-5374

The data acquired from continuous parameter monitoring shall be assessed for drifts, trends and conspicuous behavior or anomalies.

Mercedes-Benz - Confidential -	<small>Schutzvermerk DIN ISO 16016 beachten! / Refer to protection notice DIN ISO 16016! Keine Aenderung ohne Zustimmung der federfuehrenden Konstruktion / Any alterations are subject to the approval of the design department</small> Technical Component Requirement Specifications Tail lamp QEVA 111 AJPNLG	Bearb./auth.: Hans Peter Schiffert Abt./dep.: RD/KEL Datum/date: 2022-07-25 Requirement Specifications version: 001 Seite/page: 175 of 220
---	---	---

2.2.2.3.5

Test Sequence Plan (STM-869950)

2.2.2.3.5.1

Sequential Tests (STM-869949)

STM-869952
STLH-5377B

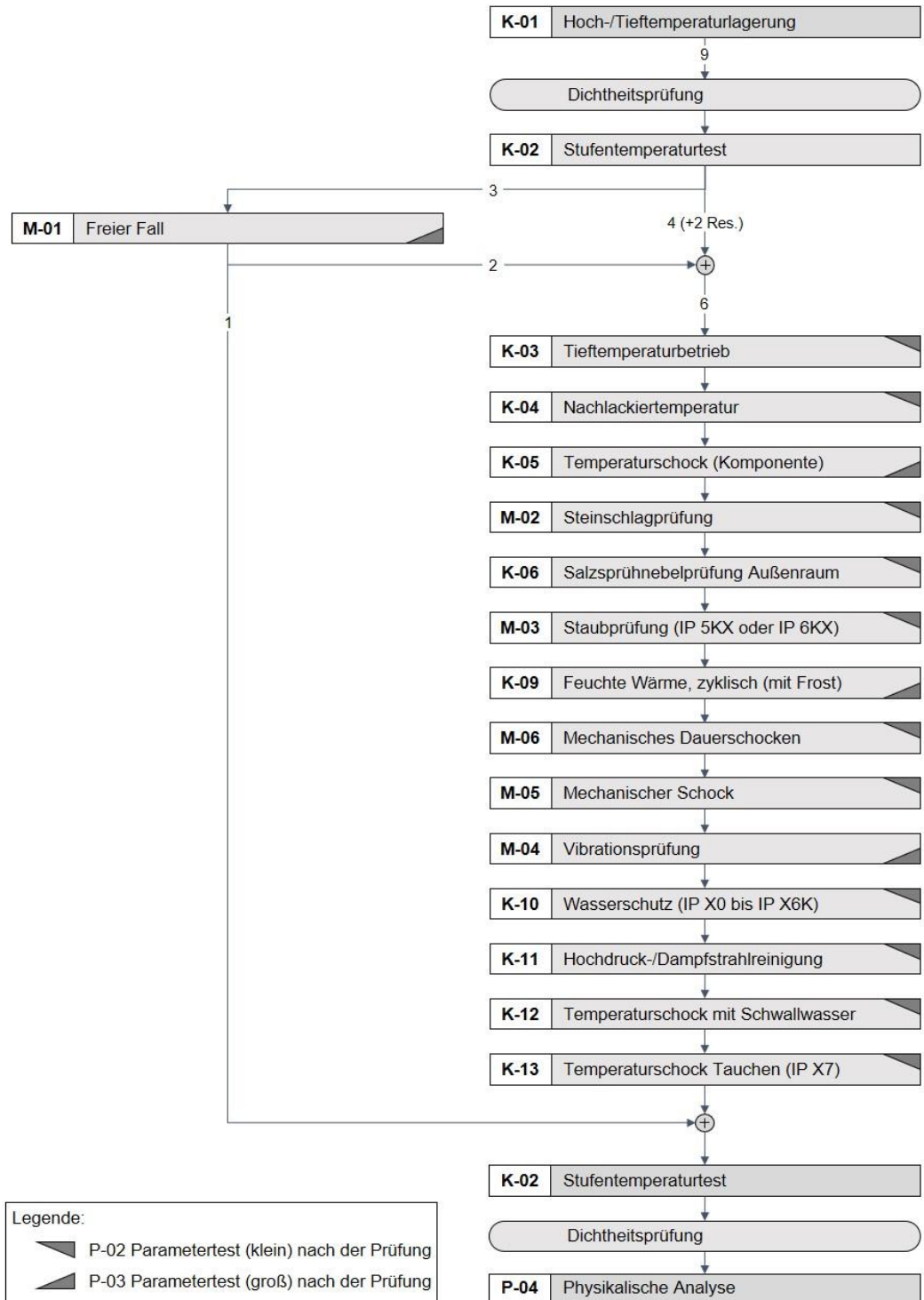

Figure: Test sequence plan – Sequential tests

Mercedes-Benz - Confidential -	<small>Schutzvermerk DIN ISO 16016 beachten! / Refer to protection notice DIN ISO 16016! Keine Aenderung ohne Zustimmung der federführenden Konstruktion / Any alterations are subject to the approval of the design department</small>	Bearb./auth.: Hans Peter Schiffert Abt./dep.: RD/KEL Datum/date: 2022-07-25
	Technical Component Requirement Specifications Tail lamp	Requirement Specifications 001 version: Seite/page: 176 of 220
	QEV 111 AJPNLG	

STM-869953
STLH-6663

If the DUTs from the test M-01 "Free fall" are not damaged, two DUTs shall be used for the further sequential test. Otherwise, the spare DUTs shall be used.

STM-869951
STLH-6664

All DUTs shall be tested with original plug or adapter starting with the test M-01 "Free fall".

2.2.2.3.5.2

Tests outside the Sequence (Parallel Tests) (STM-869954)

STM-869955
STLH-5379A

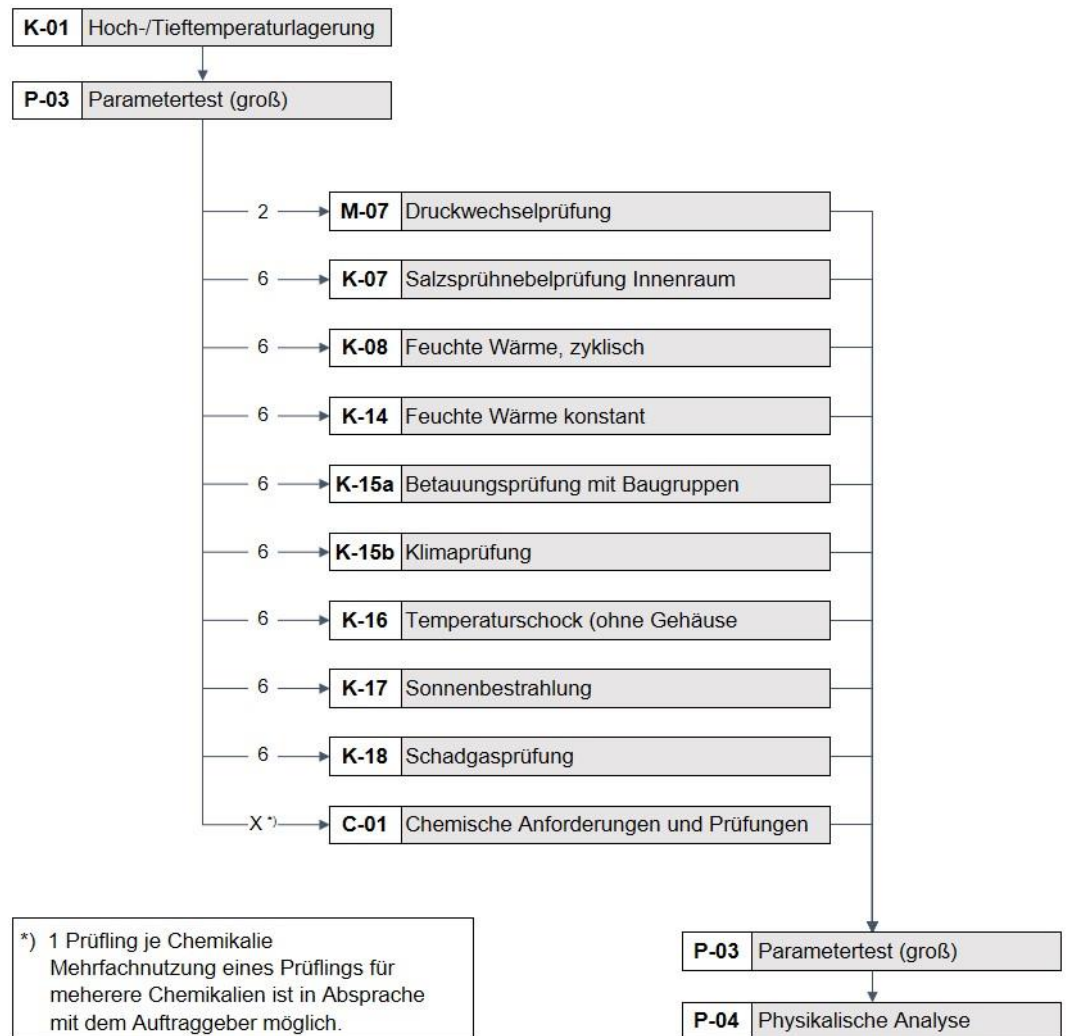

Figure: Test sequence plan – Parallel tests

Mercedes-Benz - Confidential -	<small>Schutzvermerk DIN ISO 16016 beachten! /Refer to protection notice DIN ISO 16016! Keine Änderung ohne Zustimmung der federführenden Konstruktion / Any alterations are subject to the approval of the design department</small>	Bearb./auth.: Hans Peter Schiffert Abt./dep.: RD/KEL Datum/date: 2022-07-25 Requirement Specifications 001 version: Seite/page: 177 of 220
	Technical Component Requirement Specifications Tail lamp QEV 111 AJPNLG	

2.2.2.3.5.3

Life Tests (STM-869957)

STM-869956
STLH-5381A

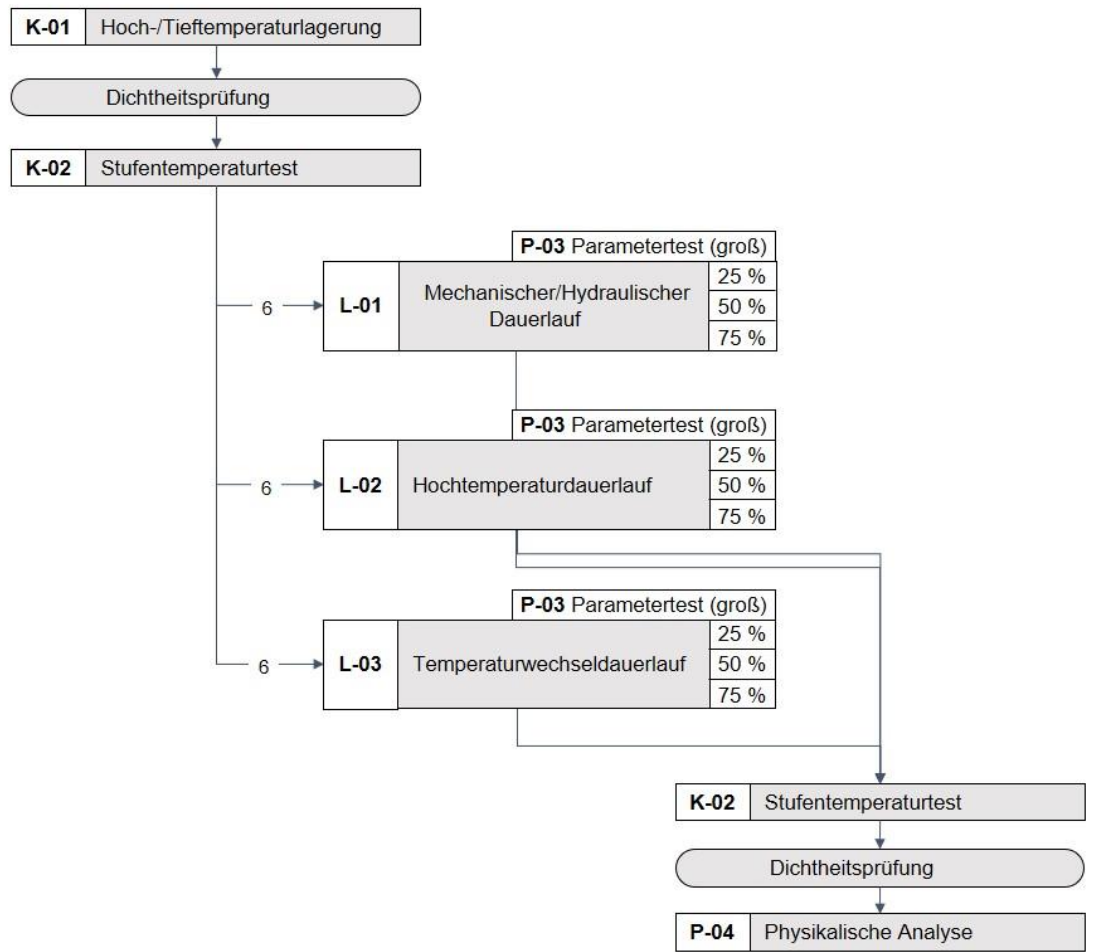

Figure: Test sequence plan – Service life

2.3

Electromagnetic Compatibility (EMC) (STM-867664)

2.3.1

General EMC Requirements (STM-867667)

STM-867668
STLH-3805H

The overall scope of the measuring methods and measurement setups as well as limit values are described in [\[MBN 10284-1\]](#) and [\[MBN 10284-2\]](#). The severity levels and test parameters shall be coordinated with the client's Development and EMC departments.

STM-867666
STLH-3806D

A test plan shall be developed by the contractor. The test plan shall be approved by the client's EMC department prior to component testing. A template for the test plan and component test report can be requested by email to emv-team@mercedes-benz.com.

Mercedes-Benz - Confidential -	<small>Schutzvermerk DIN ISO 16016 beachten! /Refer to protection notice DIN ISO 16016! Keine Aenderung ohne Zustimmung der federfuehrenden Konstruktion / Any alterations are subject to the approval of the design department</small>	Bearb./auth.: Hans Peter Schiffert Abt./dep.: RD/KEL Datum/date: 2022-07-25 Requirement Specifications 001 version: Seite/page: 178 of 220
	Technical Component Requirement Specifications Tail lamp QEV 111 AJPNLG	

STM-867669
STLH-3808A On completion of the test, the component test report shall be sent to the responsible development engineer and to the client's EMC department.

STM-867670
STLH-3807D Due date for agreed on test schedule: »Deadline for concept review 1 specified, submission 32 months before SOP at the latest«

STM-867673
STLH-3809D Due date for component test report: »20 months before SOP«

STM-867672
STLH-3810B The test plan and the component test report shall be sent to the following email address: emv-team@mercedes-benz.com. The development engineer responsible shall be copied in.

STM-867671
STLH-4697 The component test is considered the prequalification. Final release of the component is granted based on the measured values taken in the vehicle.

STM-867675
STLH-4022C *For further questions please contact the client's EMC department.*

2.3.2 Components with Bus Systems (CAN, [LIN](#), FlexRay, Ethernet, etc.) (STM-867676)

STM-867677
STLH-3813A To ensure the operability of the bus systems, the bus systems shall not be impaired, let alone blocked, during any of the interference resistance tests.

2.3.3 ESD Requirements (STM-867674)

2.3.3.1 General (STM-867678)

STM-867681
STLH-3816D For ESD-compliant manufacturing / assembly of ESD-sensitive components, corresponding verification in the form of an ESD audit shall be provided (set forth in [\[MBN 10447\]](#)).

STM-867683
STLH-3818C ESD-sensitive components (for classification see Chapter "Classification Regarding Electrostatic Sensitivity" under Requirement ID OriginID 867680) shall be handled and packaged such as to protect against ESD.

STM-867679
STLH-3819C ESD requirements on packaging for series production and replacement parts are described in OriginID 867505 Chapter "Storage Life, Packaging and Transportation".

2.3.3.2 Classification Regarding Electrostatic Sensitivity (STM-867680)

STM-867682
STLH-3821 The component is electrostatically sensitive
»No«

Mercedes-Benz - Confidential -	<small>Schutzvermerk DIN ISO 16016 beachten! / Refer to protection notice DIN ISO 16016! Keine Aenderung ohne Zustimmung der federfuehrenden Konstruktion / Any alterations are subject to the approval of the design department</small>	Bearb./auth.: Hans Peter Schiffert Abt./dep.: RD/KEL Datum/date: 2022-07-25 Requirement Specifications version: 001 Seite/page: 179 of 220
	Technical Component Requirement Specifications Tail lamp QEV 111 AJPNLG	

2.3.4 Test Conditions (STM-867685)

2.3.4.1 Operating States (STM-867686)

STM-867688
STLH-3824A

The component shall be tested in the following operating states:

STM-867684
STLH-3825

»

Name of the operating state	Description of the operating state
LIGHT FUNCTIONS ON	All light functions active – unit under test electrically connected to wiring harness – normal operation
LIGHT FUNCTIONS OFF	All light functions inactive – unit under test electrically connected to wiring harness, but not operated
UNPLUGGED	DUT not connected to wiring harness
BONDED TO GROUND	unit under test not connected to wiring harness – only ground pin connected to reference ground (HCP)

Each lamp variant shall, in general, be individually tested!

The tests listed below shall be performed in accordance with the electronics (active/passive):

- Active: With timed electronics in the lamp (e.g. μ C, IC, driver modules, etc.)
- Passive: Without pulsed electronics in the lamp«

STM-867687
STLH-6238

Note: The detailed descriptions of the operating states can be modified in the test plan. Changes and additions shall be coordinated with the client.

2.3.4.2 Test Criteria (STM-867689)

STM-867693
STLH-3827D

The client categorizes possible effects or functional deviations during the test into three different fault categories (1, 2 or 3) based on their consequences for customers.

STM-867691
STLH-4203B

All effects or functional deviations not specified are automatically classed as category 3.

STM-867690
STLH-3829C

Possible effect: »Change in current consumption after tests«
Category: »3«

3021754

Operating state: ON (All light functions active)
Possible effect: »Deactivation of light function«
Category: »3«

3021755

Only ESD test:

Mercedes-Benz - Confidential -	<small>Schutzvermerk DIN ISO 16016 beachten! /Refer to protection notice DIN ISO 16016! Keine Aenderung ohne Zustimmung der federfuehrenden Konstruktion / Any alterations are subject to the approval of the design department</small> Technical Component Requirement Specifications Tail lamp QEV 111 AJPNLG	Bearb./auth.: Hans Peter Schiffert Abt./dep.: RD/KEL Datum/date: 2022-07-25 Requirement Specifications 001 version: Seite/page: 180 of 220

Operating state: ON (all light functions active) + OFF (PLUGGED: all light functions not active)

Possible effect: »Influence on light function«

Category: »1«

3021757

Operating state: OFF (All light functions inactive)

Possible effect: »Activation of light function«

Category: »3«

STM-867692
STLH-6239

Note: Further possible effects and their associated categories can be added in the test plan. Changes and additions shall be coordinated with the client.

2.3.5 EMC Performance Requirements – Component Tests (STM-867695)

2.3.5.1 **RF Emissions – Artificial Network Measurements (AN Test) (STM-867694)**

STM-867697
STLH-3832B

Operating states of the DUT during the test (defined in Chapter Operating States):

»Light function ON

To be carried out if: active«

STM-867698
STLH-3834D

Further details can be found in [\[MBN 10284-2\]](#) Chapter 6.

2.3.5.2 **RF Emissions – Antenna Measurements (RE Test) (STM-867696)**

STM-867700
STLH-3844B

Operating states of the DUT during the test (defined in Chapter Operating States):

»Light function ON To be carried out if: active«

STM-867703
STLH-3846E

Further details can be found in [\[MBN 10284-2\]](#) Chapter 7.

2.3.5.3 **RF Emissions – Antenna Near-Field (NFA Test) (STM-867699)**

STM-867701
STLH-3836B

Operating states of the DUT during the test (defined in Chapter Operating States):

»Light function ON

To be carried out if: active«

3021759

Note: To be used only at distances between the antenna structure / antenna amplifier and the taillight of less than 50 cm.

STM-867702
STLH-6416

The following services or bands shall be tested: »AM, FM, DAB, TV«

STM-867706
STLH-6417A

Test distance from antenna structure to wiring harness and DUT: »20mm«. If the limit value is exceeded, the test shall be repeated at a distance of 50 mm and 100 mm for the relevant frequency bands.

STM-867707
STLH-3838E

Further details can be found in [\[MBN 10284-2\]](#) Chapter 8.

Mercedes-Benz - Confidential -	<small>Schutzvermerk DIN ISO 16016 beachten! / Refer to protection notice DIN ISO 16016! Keine Änderung ohne Zustimmung der federführenden Konstruktion / Any alterations are subject to the approval of the design department</small>	Bearb./auth.: Hans Peter Schiffert
	Technical Component Requirement Specifications Tail lamp QEY 111 AJPNLG	Abt./dep.: RD/KEL Datum/date: 2022-07-25 Requirement Specifications version: 001 Seite/page: 181 of 220

2.3.5.4 Transient Emissions on Supply Lines (CTE Test) (STM-867713)

STM-867710
STLH-3848A

The transient emissions shall be measured during the following switching events in the DUT: switch on, switch off, switching of connected actuators.

STM-867711
STLH-3850F

Further details can be found in [\[MBN 10284-2\]](#) Chapter 11.

2.3.5.5 RF Immunity – Bulk Current Injection (BCI Test) (STM-867712)

STM-867715
STLH-3852B

Operating states of the DUT during the test (defined in Chapter Operating States):
»Light function ON + Light function OFF
To be carried out if: active/passive«

STM-867714
STLH-3854E

Further details can be found in [\[MBN 10284-2\]](#) Chapter 13.

2.3.5.6 RF Immunity: OPTION 1 – Antenna Irradiation (ALSE Test), OPTION 2 – Reverberation Chamber (CRC Test) (STM-867716)

STM-867718
STLH-3856B

Operating states of the DUT during the test (defined in Chapter Operating States):
»Light function ON + Light function OFF
To be carried out if: active/passive«

STM-867717
STLH-3858F

Additional details can be found in [\[MBN 10284-2\]](#), Chapter 14 (ALSE Test) and Chapter 15 (CRC Test) respectively.

2.3.5.7 Transients on Supply Lines (TSUP Test) (STM-867719)

STM-867722
STLH-3868B

Operating states of the DUT during the test (defined in Chapter Operating States):
»Light function ON
To be carried out if: active/passive«

STM-867725
STLH-3870F

Further details can be found in [\[MBN 10284-2\]](#) Chapter 17.

2.3.5.8 Transients on Lines Other than Supply Lines (TOL Test) (STM-867727)

STM-867726
STLH-3872B

Operating states of the DUT during the test (defined in Chapter Operating States):
»Light function ON
To be carried out if: active«

STM-867724
STLH-3874F

Further details can be found in [\[MBN 10284-2\]](#) Chapter 18.

2.3.5.9 Electrostatic Discharge – Handling Test (ESDH Test) (STM-867728)

STM-867730

Operating state of the component during the test: Power off, component disconnected.

Mercedes-Benz - Confidential -	<small>Schutzvermerk DIN ISO 16016 beachten! / Refer to protection notice DIN ISO 16016! Keine Aenderung ohne Zustimmung der federfuehrenden Konstruktion / Any alterations are subject to the approval of the design department</small>	Bearb./auth.: Hans Peter Schiffert
	Technical Component Requirement Specifications Tail lamp QEV 111 AJPNLG	Abt./dep.: RD/KEL Datum/date: 2022-07-25 Requirement Specifications version: 001 Seite/page: 182 of 220

STLH-3876A To be performed for: Active/passive

STM-867733
STLH-3879 Discharge network (ESDH test): 150 pF / 330 Ω

STM-867732
STLH-3880F Further details can be found in [\[MBN 10284-2\]](#) Chapter 19.

2.3.5.10 Electrostatic Discharge (Powered Up) – Direct Discharge (ESDD Test) (STM-867729)

STM-867731
STLH-3882B Operating states of the DUT during the test (defined in Chapter Operating States):
»Light function ON
To be carried out if: active/passive«

STM-867735
STLH-3885C Discharge network (ESDD test): 330 pF / 330 Ω

STM-867736
STLH-3886G For further details, including on discharge points, see [\[MBN 10284-2\]](#), Chapter 20.

2.3.5.11 Electrostatic Discharge (Powered Up) – Indirect Discharge (ESDI Test) (STM-867734)

STM-867737
STLH-3888B Operating states of the DUT during the test (defined in Chapter Operating States):
»Light function ON
To be carried out if: active/passive«

STM-867738
STLH-3891 Discharge network (ESDI test): 330 pF / 330 Ω

STM-867741
STLH-3892G For further details, including on discharge points, see [\[MBN 10284-2\]](#), Chapter 21.

2.3.6 EMC Performance Requirements – Vehicle Tests (STM-867739)

STM-867740
STLH-4704 *The vehicle tests are performed on the client's premises.*

2.3.6.1 On-Vehicle Antenna Measurements (CISPR25 Test) (STM-867743)

STM-867742
STLH-3895B Operating states of the DUT during the test (defined in Chapter Operating States):
»Light function ON
To be carried out if: active/passive«

STM-867745
STLH-3897C Further details can be found in [\[MBN 10284-1\]](#) Chapter 5.

2.3.6.2 Reference Receiver Measurement on Vehicle Antennas (REF Test) (STM-1235373)

STM-1235381 Operating states of the DUT during the test (defined in Chapter Operating

Mercedes-Benz - Confidential -	<small>Schutzvermerk DIN ISO 16016 beachten! / Refer to protection notice DIN ISO 16016! Keine Änderung ohne Zustimmung der federführenden Konstruktion / Any alterations are subject to the approval of the design department</small>	Bearb./auth.: Hans Peter Schiffert
	Technical Component Requirement Specifications Tail lamp QEV 111 AJPNLG	Abt./dep.: RD/KEL Datum/date: 2022-07-25 Requirement Specifications version: 001 Seite/page: 183 of 220

STLH-7255 States): »Light function ON
To be carried out if: active/passive«

STM-1235385
STLH-7256 Further details can be found in [\[MBN 10284-1\]](#) Chapter 6.

2.3.6.3 Emission Measurement with Off-Board Antenna (CISPR12 Test) (STM-867747)

STM-867746
STLH-3899A The operating states of the vehicle during the test are defined in CISPR12:
- With battery on but engine off
- With engine on (running)

3021784 Light function ON
To be carried out if: active/passive

STM-867744
STLH-3901D Further details can be found in [\[MBN 10284-1\]](#) Chapter 7.

2.3.6.4 Magnetic Field Emission (MFE Test) (STM-867748)

STM-867752
STLH-3903B The vehicle operating states during the test are defined in [\[MBN 10284-1\]](#), Chapter 8.

STM-867753
STLH-3905D Further details can be found in [\[MBN 10284-1\]](#) Chapter 8.

2.3.6.5 Immunity; OPTION 1 – To Off-Vehicle Transmitters (OVRS Test); OPTION 2 – Test in the Reverberation Chamber (RC Test) (STM-867749)

STM-867751
STLH-3907B Operating states of the vehicle/unit under test during the test (defined in the Chapter Operating States): »Light function ON + Light function OFF
To be carried out if: active/passive«
Additional details can be found in [\[MBN 10284-1\]](#), Chapter 9 (OVRS Test) and Chapter 10 (RC Test) respectively.

STM-867754
STLH-3909E

2.3.6.6 Immunity to Transmitters Installed in the Vehicle by the Customer (OBT Test) (STM-867755)

STM-867758
STLH-3911B Operating states of the DUT during the test (defined in Chapter Operating States):
»Light function ON + Light function OFF
To be carried out if: active/passive«

STM-867756
STLH-3913D Further details can be found in [\[MBN 10284-1\]](#) Chapter 11.

2.3.6.7 Immunity to Permanently Installed In-Vehicle Transmitters (OBT2 Test) (STM-867757)

STM-867762 Operating states of the vehicle/unit under test during the test (defined in the Chapter

Mercedes-Benz - Confidential -	<small>Schutzvermerk DIN ISO 16016 beachten! /Refer to protection notice DIN ISO 16016! Keine Aenderung ohne Zustimmung der federfuehrenden Konstruktion / Any alterations are subject to the approval of the design department</small>	Bearb./auth.: Hans Peter Schiffert
	Technical Component Requirement Specifications Tail lamp QEV 111 AJPNLG	Abt./dep.: RD/KEL Datum/date: 2022-07-25 Requirement Specifications version: 001 Seite/page: 184 of 220

STLH-6244 Operating States): »Light function ON + Light function OFF
To be carried out if: active/passive«

STM-867760 Further details can be found in [\[MBN 10284-1\]](#) Chapter 12.
STLH-6245A

2.3.6.8 Immunity to Portable Transmitters (PT Test) (STM-867759)

STM-867761 Operating states of the DUT during the test (defined in Chapter Operating States):
STLH-3915B »Light function ON + Light function OFF
To be carried out if: active/passive«

STM-867763 Further details can be found in [\[MBN 10284-1\]](#) Chapter 13.
STLH-3917E

2.3.6.9 Electrostatic Discharges (ESD Test) (STM-867764)

STM-867765 Operating states of the DUT during the test (defined in Chapter Operating States):
STLH-3919B »Light function ON + Light function OFF
To be carried out if: active/passive«

STM-867766 Discharge network (ESD test): "150 pF / 330 Ω "
STLH-3923C

STM-867768 *Note: An indirect discharge at metallic structures in the exit/entry area (e.g. A-pillars,
STLH-3924A door) is generally performed (discharge network 330 pF / 330 Ω).*

STM-867767 For further details, including on discharge points, see [\[MBN 10284-1\]](#), Chapter 14.
STLH-3925F

2.4 General E/E Requirements (STM-868102)

2.4.1 E/E Properties (STM-868101)

2.4.1.1 Electrical Requirements (STM-868105)

2.4.1.1.1 12 V On-Board Electrical System Requirements (STM-868104)

STM-868103 **Contact for the 12 V on-board electrical system**
STLH-3948G *Email: bordnetz@mercedes-benz.com*

STM-868106 The overall scope of the measuring methods, measurement setups and limit values is
STLH-3978F described in [\[MBN 10567\]](#).

STM-868109 The application of [\[MBN 10567\]](#) is obligatory for the component.
STLH-5594B

STM-868108 The tests shall be performed at all sample phases.
STLH-6439

Mercedes-Benz - Confidential -	<small>Schutzvermerk DIN ISO 16016 beachten! /Refer to protection notice DIN ISO 16016! Keine Aenderung ohne Zustimmung der federfuehrenden Konstruktion / Any alterations are subject to the approval of the design department</small>	Bearb./auth.: Hans Peter Schiffert
	Technical Component Requirement Specifications Tail lamp QEVE 111 AJPNLG	Abt./dep.: RD/KEL Datum/date: 2022-07-25 Requirement Specifications version: 001 Seite/page: 185 of 220

STM-868110
STLH-6668

Function: Signal light functions Function class: See requirements from testing.

STM-868111
STLH-5416B

[\[AV Bordnetz\]](#) defines model series-specific requirements and additional boundary conditions for E/E components that are defined differently or not at all in [\[MBN 10567\]](#). [\[AV Bordnetz\]](#) is binding and has priority before [\[MBN 10567\]](#).

2.4.2

E/E Interfaces (STM-868203)

2.4.2.1

Electrical Interfaces (STM-868201)

STM-868202
STLH-722C

Electrical interfaces should always be designed so that there is no loss or falsification of information.

STM-868205
STLH-723C

Electrical interfaces shall be designed to prevent irreparable damage to the component, including damage caused by electrostatic discharge (ESD), during adaptation to integrated sensors/actuators or to other control units.

STM-868209
STLH-724D

Electrical interfaces shall be designed to prevent irreparable damage due to any short circuiting that may occur during adaptation or when handling live components.

STM-868206
STLH-4722D

General requirements for electrical interfaces can be found in the document [\[LHV 310 00x\]](#) in Chapter "E/E Assembly Requirements" under Requirement ID CRQ-2380.

2.4.2.2

General Connection Requirements (STM-868207)

STM-868208
STLH-2031G

The document [\[A2210002699\]](#) shall be used for connection systems.

STM-868211
STLH-2032I

The connection systems shall be certified in accordance with the [\[MBN 10384\]](#), [\[MBN 10384-1\]](#), [\[MBN 10384-2\]](#), [\[MBN 10384-3\]](#) testing guidelines.

STM-868213
STLH-5651

In addition, the requirements from Chapter "Fire Prevention Criteria" pertaining to electrical interfaces and components shall also be implemented.

STM-868215
STLH-2034

The forces produced during plugging shall be absorbed within the component.

STM-868214
STLH-2035D

In case of changes to the component connections during series production (e.g. tool wear, duplication, etc.), the contractor shall check whether the relevant implementation regulation (AV) still corresponds to the current status.

STM-868217
STLH-2036C

If a modified AV exists, the client must define which [AV](#) is to be used together with the contractor.

STM-868220
STLH-2028C

The pins shall be designed such that the maximum possible currents cannot cause irreparable damage to the connection system. This is, for instance, to be taken into account in the protection concepts (selection of fuses), or when selecting the driver output stages.

STM-868218
STLH-2030

The pin assignment for all connections shall be documented on the release drawing.

<p>Mercedes-Benz - Confidential -</p>	<p><small>Schutzvermerk DIN ISO 16016 beachten! /Refer to protection notice DIN ISO 16016! Keine Aenderung ohne Zustimmung der federfuehrenden Konstruktion / Any alterations are subject to the approval of the design department</small></p> <p>Technical Component Requirement Specifications Tail lamp QEV 111 AJPNLG</p>	<p>Bearb./auth.: Hans Peter Schiffert Abt./dep.: RD/KEL Datum/date: 2022-07-25 Requirement Specifications 001 version: Seite/page: 186 of 220</p>
--	--	---

STM-868216
STLH-2033H

The requirements described in [\[MBN 10447\]](#) shall be fulfilled when the component is inserted and removed during the manufacturing process (e.g. during testing).

2.4.2.3

Communications Interfaces (STM-868221)

STM-868225
STLH-5944A

The general requirements for communication interfaces for the CAN/[LIN](#)/FlexRay/Ethernet bus systems are described in [\[MSS 20200\]](#).

The specific requirements for the different bus systems are found in separate documents:

STM-868223
STLH-5425D

CAN: [\[MSS 20202\]](#)

STM-868226
STLH-5946A

The contractor shall use a test suite to verify the conformity of the respective communications interface at each release. To this end, the contractor shall submit the test suite report to the client with each EE release. The test suite requirements can be found in document [\[MSS 20220\]](#).

2.4.2.3.1

Operational Reliability in the Event of Communications Failure (STM-1207555)

STM-1207561
STLH-7247

As a general rule, faults with or failure of communications shall not place the control unit in an undefined state.

STM-1207564
STLH-7248

Faults with or failure of communications can also be caused by measuring technology in the vehicle (e.g. data loggers, looping in Ethernet TAPs).

STM-1207565
STLH-7249

If relevant communication requirements are still in place after a fault with or failure of communications, communications shall be restored promptly in accordance with the specifications for the bus system in question.

STM-1207567
STLH-7250

If it has not been clearly defined how to respond in the event of communications faults, the contractor shall notify the client of this and request instructions for how to proceed.

STM-1207568
STLH-7251

If certain communications faults are not caught in the as-delivered state (e.g. early sample stages), this shall be mentioned expressly in the respective release notes.

2.4.3

E/E Component Elements (STM-868250)

2.4.3.1

Component Element Selection (STM-868249)

STM-868252
STLH-1967C

In building components, the contractor shall only use component elements which, under consideration of the component design, are verifiably suitable and qualified for achieving the mission profile required for the component. Proofs to this effect shall be submitted by the contractor on the request of the client.

Mercedes-Benz - Confidential -	<small>Schutzvermerk DIN ISO 16016 beachten! /Refer to protection notice DIN ISO 16016! Keine Aenderung ohne Zustimmung der federfuehrenden Konstruktion / Any alterations are subject to the approval of the design department</small>	Bearb./auth.: Hans Peter Schiffert
	Technical Component Requirement Specifications Tail lamp QEV 111 AJPNLG	Abt./dep.: RD/KEL Datum/date: 2022-07-25 Requirement Specifications 001 version: Seite/page: 187 of 220

2.4.3.2 Risk Component Elements (STM-868251)

STM-868254
STLH-275A The contractor is obliged to provide the data and information required for risk component element evaluation.

STM-868253
STLH-276B The contractor shall classify as risk component elements such new component elements/component element technologies that are used for the first time in a vehicle application by the client.

STM-868255
STLH-277B *In addition, known component elements used in new or modified operating conditions (e.g. in another installation zone in the vehicle) shall be deemed to be risk component elements.*

STM-868257
STLH-278B When analyzing risk component elements, the contractor shall perform the following tasks:

- Determine the limits of the component elements
- Evaluate the technology in terms of the mission profile
- Eliminate the risks through preventive measures

2.4.3.3 Selection of Semiconductors (STM-868256)

STM-868259
STLH-6810 The contractor shall use only semiconductor components (in particular, microcontrollers) that comply with the requirements of [\[MBN 10326\]](#).

STM-868260
STLH-6811 The contractor shall use only semiconductor components (in particular, microcontrollers) that comply with the requirements of [\[MBN 10527-1\]](#) and [\[MBN 10527-2\]](#).

STM-868258
STLH-6812 For control units with cryptographic keys, the contractor shall select only microcontrollers with a hardware security module or a comparable hardware security level and use them to store keys

2.4.3.4 Semiconductor Component Elements for FlexRay, CAN, LIN and Ethernet (STM-868261)

STM-868264
STLH-3576F For the selection of transceivers/SBCs (system basis chips) or integrated semiconductor component elements with a network interface, the document [\[MSS 20202\]](#) shall be taken into account for the CAN.

STM-1215289
STLH-7134A The contractor shall ensure that the CAN controller (in the microcontroller) is implemented in accordance with [\[ISO 11898-1\]](#) and the conformity as per [\[ISO 16845\]](#) is verified.

2.4.3.5 Rare Earths (STM-868271)

STM-868272
STLH-5476 Where rare earths are used, the contractor shall disclose the composition used in the application (e.g in magnets), in particular the specific weight fractions of dysprosium and terbium as well as neodymium. When submitting the tender, the contractor shall present the sourcing concept for these materials throughout the life cycle. Alternative

Mercedes-Benz - Confidential -	Schutzvermerk DIN ISO 16016 beachten! /Refer to protection notice DIN ISO 16016! Keine Aenderung ohne Zustimmung der federfuehrenden Konstruktion / Any alterations are subject to the approval of the design department	Bearb./auth.: Hans Peter Schiffert Abt./dep.: RD/KEL Datum/date: 2022-07-25 Requirement Specifications 001 version: Seite/page: 188 of 220
	Technical Component Requirement Specifications Tail lamp QEV 111 AJPNLG	

concepts requiring no or only minimal amounts of rare earths shall also be offered.

2.4.3.6 Printed Circuit Boards (STM-868273)

STM-868274
STLH-5643

Due to the relatively high tendency to migration and corrosion, the use of printed circuit boards with surfaces containing chemical silver (chem. Ag), is not permitted in control units and other electronic assemblies.

2.4.4 E/E Design Rules and Lessons Learned (STM-868278)

STM-868277
STLH-4389A

During product design and manufacturing processes, the contractor shall implement the "lessons learned" from the client's predecessor projects and from the contractor's own projects and processes.

STM-868280
STLH-425I

The client takes the knowledge gained from further technological developments and from customer complaint analyses and summarizes this knowledge to form design rules. The design rules for E/E components are documented in [\[MBN 10463\]](#) and shall be taken into account during the development of the component.

2.4.5 E/E Processes (STM-868292)

2.4.5.1 Delta Certification (STM-1236720)

STM-1236886
STLH-7208

The contractor shall certify each hardware or process change during the series production phase, e.g. changes to and of component elements, to the component design or to the manufacturing process for the component and component elements.

STM-1236887
STLH-7209A

The contractor shall determine the scope of this delta certification on the basis of [\[MBN 10599\]](#) and the certification scopes defined in these component requirement specifications.

STM-1236888
STLH-7210

The delta certification scopes determined by the contractor shall be confirmed by the specialist units concerned at the client's development and quality departments prior to the start of certification. The notification deadlines set in [\[MBN 10447\]](#) shall be complied with.

STM-1236890
STLH-7211A

The contractor shall record the results of delta certification and submit them to the client upon request.

2.4.6 E/E Data (STM-868301)

STM-868303
STLH-1970K

Further requirements can be found in Chapter "Product Data Management" of the document [\[LHV 310 00x\]](#) under CRQ-292, particularly in Chapter "Supplements for E/E Processes" under CRQ-486.

STM-868305
STLH-1416A

As verification of adherence to the requirement specifications, the contractor shall submit its test results to the client.

STM-868307
STLH-1417B

For each sample phase, the contractor shall continuously submit drawings, wiring diagrams, layout diagrams, parts lists, the relevant data sheets and E/E data, on

Mercedes-Benz - Confidential -	<small>Schutzvermerk DIN ISO 16016 beachten! / Refer to protection notice DIN ISO 16016! Keine Änderung ohne Zustimmung der federführenden Konstruktion / Any alterations are subject to the approval of the design department</small>	Bearb./auth.: Hans Peter Schiffert
	Technical Component Requirement Specifications Tail lamp QEV 111 AJPNLG	Abt./dep.: RD/KEL Datum/date: 2022-07-25 Requirement Specifications version: 001 Seite/page: 189 of 220

request, to the client's responsible Development departments via the Engineering Portal of the E/E product data management system (EPDM).

STM-868308
STLH-2735

For each component change, the contractor shall, without specific request, submit drawings, wiring diagrams, layout diagrams, parts lists and the relevant data sheets to the client's responsible Development departments.

STM-868310
STLH-2736

Prior to the execution of changes, the contractor shall, without specific request, submit drawings and data to the client.

2.4.7

E/E Documentation (STM-868306)

STM-868309
STLH-152F

The following items for hardware documentation shall be prepared by the contractor:

STM-868312
STLH-153

- Design drawings

STM-868314
STLH-154

- Circuit diagram

STM-868311
STLH-155D

- Layout diagram

STM-868313
STLH-157

- Connector assignment(s)

STM-868315
STLH-156A

- Parts list

STM-868319
STLH-158

- Specification and data sheets of components

STM-868317
STLH-2741C

- Parts history (see document [\[LHV 310 00x\]](#) under Requirement ID CRQ-2235).

STM-868316
STLH-160

- Component tolerance calculation

STM-868320
STLH-163D

- Voltage level definition of inputs and outputs

STM-868318
STLH-5490A

- Internal circuit diagram of bus interface (CAN, [LIN](#), FlexRay, Ethernet)

STM-868323
STLH-164

- Results of EMC tests (on the component and in the vehicle)

STM-868321
STLH-5491

- Heat distribution on PCB at rated load and at room/maximum temperature

STM-868322
STLH-5492

- Thermal management

STM-868325
STLH-161C

- Function description (incl. circuit parts)

STM-868324
STLH-162

- Storage allocation

STM-868330
STLH-166

- Test and inspection concept (function test, in-circuit test, run-in, burn-in, etc.)

<p>Mercedes-Benz - Confidential -</p>	<p><small>Schutzvermerk DIN ISO 16016 beachten! / Refer to protection notice DIN ISO 16016! Keine Aenderung ohne Zustimmung der federfuehrenden Konstruktion / Any alterations are subject to the approval of the design department</small></p> <p>Technical Component Requirement Specifications Tail lamp QEV 111 AJPNLG</p>	<p>Bearb./auth.: Hans Peter Schiffert Abt./dep.: RD/KEL Datum/date: 2022-07-25 Requirement Specifications 001 version: Seite/page: 190 of 220</p>
--	---	---

- STM-868327
STLH-2739A - Test specification
- STM-868326
STLH-167D - Qualification results
- STM-868329
STLH-159F - Product [FMEA](#) extending to the component element level (multipoint connector, housing, etc.), see document [\[LHV 310 00x\]](#) under Requirement ID CRQ-249.
- STM-868328
STLH-165F - Process [FMEA](#) (see document [\[LHV 310 00x\]](#) under the Requirement ID CRQ-249).
- STM-868332
STLH-1955C - If further methods (event tree analysis, fault tree analysis, etc.) are employed for analysis, the contractor shall document these.

2.5 Fire Prevention Criteria (STM-867313)

2.5.1 Electrics/Electronics (STM-867321)

2.5.1.1 Wiring Harness (STM-867320)

2.5.1.1.1 Basic Rules on Routing Electrical Lines in Vehicles (STM-867326)

- STM-867324
STLH-5897 To ensure the reproducibility of wiring harness installation during assembly, routing aids (in the form of colored markings, fastening points, etc.) shall be provided as guides.
- STM-867322
STLH-5898 The lines shall be permanently secured to prevent accidental movement during assembly or driving that could lead to chafing.
- STM-867323
STLH-5899 The length of the lines shall be selected such that Assembly can install the wiring harness with no tension placed on it and with no unwanted excess length.
- STM-867325
STLH-5900 Assembly shall ensure that the wiring harness is installed with no tension placed on it.
- STM-867330
STLH-5901 Electrical lines shall not be routed over sharp edges, bodyshell pins, welding residues or bolt/screw points because vibrations during driving or other stresses may cause damage (chafing, tearing, etc.) to the lines at these points. Apart from that, appropriate protective measures shall be implemented.
- STM-867328
STLH-5902 It shall be ensured that electric lines cannot be pinched during assembly. It shall also be ensured that they cannot be pinched or otherwise damaged while in the customer's possession during predictable types of handling and use.
- STM-867327
STLH-5903 Cable shoes that may possibly be exposed to moisture and that are mated to a vacuum-producing component shall be sealed.
- STM-867331
STLH-5904 Sufficient clearance to moving component parts and heat-generating components shall be maintained at all times in order to prevent thermal and mechanical damage to

Mercedes-Benz - Confidential -	Schutzvermerk DIN ISO 16016 beachten! /Refer to protection notice DIN ISO 16016! Keine Aenderung ohne Zustimmung der federfuehrenden Konstruktion / Any alterations are subject to the approval of the design department	Bearb./auth.: Hans Peter Schiffert Abt./dep.: RD/KEL Datum/date: 2022-07-25 Requirement Specifications 001 version: Seite/page: 191 of 220
	Technical Component Requirement Specifications Tail lamp QEV 111 AJPNLG	

the lines (e.g. steering column adjustment, hood hinges, exhaust system, transmission housing, heat sink for hydraulic pump, etc.).

STM-867329
STLH-5905

Electrical cables shall be designed for mechanical and environmental stresses (e.g. Electrical Cables for Motor Vehicles [\[MBN LV 112-1\]](#)).

STM-867333
STLH-6143

Lines shall be selected and routed such as to rule out line breakage caused by movement. This applies in particular where voltages are >12V

STM-867335
STLH-5906

Installation of lines on weld flanges shall be avoided; if this is not possible, protective measures (e.g. edge trims or cable ducts) shall be implemented.

2.5.1.1.2 Insulation (STM-867336)

STM-867334
STLH-5908

The insulation of the electrical lines used (including within components or cable ends) shall fulfill the test conditions of the testing guideline (see Electrical Cables for Motor Vehicles [\[MBN LV 112-1\]](#)).

2.5.1.1.3 Plug Connections / Connecting Points of Distributor Rails (STM-867337)

STM-867340
STLH-5910

Contact housings shall be designed to rule out the risk of confusion (for control units with multiple connectors, code by color and geometry; see, for example, Design Guidelines for Connection Systems [\[A2210002699\]](#)).

STM-867339
STLH-5912

For line installation, account shall be taken of the minimum bending radii in the coupling/feed area on both sides of the connection and tension-free installation shall be ensured. For waterproof plug connections in particular, tension-free installation with line exiting axially from the plug connector housing shall be ensured (no overly sharp bend directly at contact housing to ensure, for example, a tight seal).

STM-867341
STLH-5913

Plug connections in wet areas shall have a watertight design (see, for example, Design Guidelines for Connection Systems [\[A2210002699\]](#), test in accordance with Automotive Connectors - Test Specification [\[MBN 10384\]](#) or Electric/Electronic Requirements for [HV](#) connectors [\[MBN LV 215\]](#)).

STM-867344
STLH-5914

The connections (including at the cable ends) shall fulfill the test conditions of the testing guideline (see Automotive Connectors – Test Specification [\[MBN 10384\]](#) or Electric/Electronic Requirements for [HV](#) Connectors [\[MBN LV 215\]](#)).

STM-867346
STLH-5915

The electrical contact shall be durably secured (e.g. using a suitable mechanical connection by complying with the tightening instructions, placement of the cable shoe on the contact surface, no contaminants on the contact surface, etc.).

2.6 Assembly (STM-867504)

2788868
FI MH-2140

The assembly sequence is the same as the series.

2788869
FI MH-1518

The contractor shall design the component taking into account the production cycle times so that assembly methods are used in the MB AG plant that are as cost- and

Mercedes-Benz - Confidential -	<small>Schutzvermerk DIN ISO 16016 beachten! /Refer to protection notice DIN ISO 16016! Keine Aenderung ohne Zustimmung der federfuehrenden Konstruktion / Any alterations are subject to the approval of the design department</small>	Bearb./auth.: Hans Peter Schiffert Abt./dep.: RD/KEL Datum/date: 2022-07-25 Requirement Specifications 001 version: Seite/page: 192 of 220
	Technical Component Requirement Specifications Tail lamp QEV 111 AJPNLG	

time-saving as possible.

2788870
FI MH-1519

The contractor shall design the lamp so that the assembly and disassembly of the component can be performed with commercially available tools.

2788871
FI MH-1520

The contractor shall design the lamp so that no additional safety devices are required during assembly and disassembly.

2788872
FI MH-1521

The contractor shall design the lamp so that the peripheral parts cannot be damaged in the case of the correct assembly and disassembly of the lamp and/or fasteners.

2788873
FI MH-1540

The contractor shall design the lamp so that the tightening torque is 5 Nm +/- 1 Nm.

2788874
FI MH-2954

The non-destructive removal/installation of the lamps in <10 min without the removal/installation of adjacent component parts shall be ensured.

STM-867503
STLH-2976D

The contractor shall comply with the general assembly requirements in the Chapter "Assembly Requirements" of the document [\[LHV 310 00x\]](#) under the Requirement ID CRQ-2480.

2.7

Shelf Life, Packaging and Transportation (STM-867505)

STM-867506
STLH-4709C

The contractor shall adhere to the standardized after-sales requirements given in the "Shelf Life, Packaging, and Transportation" Chapter of the document [\[LHV 310 00x\]](#) under the Requirement ID CRQ-2435.

STM-1249332
STLH-7213

The component is a visible part for the customer and it shall be specially packed, transported, and installed. (see logistics component requirement specifications).

2.8

After-Sales (STM-867511)

STM-867512
STLH-832G

The contractor shall comply with the standardized After-Sales requirements in the Chapter "After-Sales and Service" of the document [\[LHV 310 00x\]](#) under Requirement ID CRQ-2008.

STM-867515
STLH-5546A

For the CCC certification (see requirement ID CRQ-363 in the document [\[LHV 310 00x\]](#)), it shall be noted that certification is required for all variants and sub-components (substructure parts) defined as replacement parts of these components.

STM-867513
STLH-6419B

After-sales-relevant substructure parts (replacement parts) can be [DS-/DZ](#)-relevant. STLH-193 and CRQ-1665 in the document [\[LHV 310 00x\]](#) shall be implemented for this purpose.

2831775

In the context of certification, the supplier shall ensure that all substructure components specific to replacement parts are also certified.

STM-867517
STLH-5550

The requirements listed below define supplements and modifications to the standardized requirements from the previous chapter taking into consideration the special properties of the target vehicle model series.

Mercedes-Benz - Confidential -	<small>Schutzvermerk DIN ISO 16016 beachten! /Refer to protection notice DIN ISO 16016! Keine Aenderung ohne Zustimmung der federfuehrenden Konstruktion / Any alterations are subject to the approval of the design department</small>	Bearb./auth.: Hans Peter Schiffert
	Technical Component Requirement Specifications Tail lamp QEY 111 AJPNLG	Abt./dep.: RD/KEL Datum/date: 2022-07-25 Requirement Specifications version: 001 Seite/page: 193 of 220

STM-867514
STLH-2979

If special and standardized requirements cannot be implemented simultaneously, the contractor shall coordinate with the client's responsible department on the design of the component with regard to critical points.

STM-867518
STLH-5553

In addition, the following requirements shall be fulfilled:

2788876

The main light equipment tools (housing, reflector, lens) and the corresponding secondary tools are to be equipped with a shot counter of the "mold mind" brand before the start of production. The final definition of the tools to be equipped with shot counters shall take place in consultation with Technology After-Sales department (GSP/TPE). The shot counters and the tools are to be given Daimler inventory numbers and documented in the tool tracking sheet under the corresponding tools.

2788877

The light equipment is identified on the inside with the "Mercedes-Benz" logo in consultation with the relevant design department. In line with [MBN 10435-C-A-8](#), the lamp unit lens is countersunk, and in line with [MBN 10435-C-B-6](#), the rear light lenses are countersunk with a Mercedes-Benz star.

2788878

All component parts of the light equipment shall be identified as off-tool as per [\[MBN 10435\]](#). Deviation is permissible if there is limited space available or if the component part is used for different item numbers. All deviations from this identification shall be coordinated with the corresponding component design manager of the technology after-sales department (GSP/TPE), which is also responsible for approving them.

2788880

The manufacturer's trademark may be applied on request; the manufacturer's trademark shall not be larger than the Daimler trademark. The defined protection zones of the Daimler trademarks shall be complied with in this connection. Additional other manufacturer's specifications, in particular the manufacturer's item number, are not permitted. Legally required identification has priority over other information. If there is little space available, the Daimler trademark and item number have priority over other information. It is not permitted that solely the manufacturer's trademark is visible in the installed status.

2995668

An identification with the supplier part number is not permitted. Identification of the part with the supplier's trademark is only permitted if the part shall be certified using the trademark of the supplier. This supplier brand identification takes place once and only in the area that is not visible after installation, independent of the certification number. It is not larger than the Mercedes-Benz brand logo and not made of off-tool parts. All deviations from this identification shall be coordinated with the corresponding component design manager of the technology after-sales department (GSP/TPB), which is also responsible for approving them. Standard labels that do not comply with the described specifications are not permitted.

2788881

Adhesive labels on the headlamps/taillights that do not comply with the [\[MBN 10435\]](#) specifications are not permitted and shall be adjusted subsequently free of charge where applicable.

<p>Mercedes-Benz - Confidential -</p>	<p><small>Schutzvermerk DIN ISO 16016 beachten! /Refer to protection notice DIN ISO 16016! Keine Aenderung ohne Zustimmung der federfuehrenden Konstruktion / Any alterations are subject to the approval of the design department</small></p> <p>Technical Component Requirement Specifications Tail lamp QEV 111 AJPNLG</p>	<p>Bearb./auth.: Hans Peter Schiffert Abt./dep.: RD/KEL Datum/date: 2022-07-25 Requirement Specifications 001 version: Seite/page: 194 of 220</p>
---	--	---

3 Contacts and Responsibilities (STM-867520)

3.1 Client's Contacts (STM-867521)

STM-867523
STLH-4398A The client's contacts are listed in the following section.

STM-867525
STLH-1498B **Component manager**

E-mail: »nicole.berwanger@mercedes-benz.com«

3411506
STLH-2698A **Light technology**

E-mail: »dennis.schneider@mercedes-benz.com«

3411509
STLH-2698A **E/E interface**

E-mail: »dennis.schneider@mercedes-benz.com«

STM-867524
STLH-2698A **After-Sales**

Email: »holger.schnorr@mercedes-benz.com«

STM-867526
STLH-3949C **Product Cost Engineering**

E-mail: »andre.mandaric@mercedes-benz.com«

STM-867526
STLH-3949C **Product Cost Engineering – Tools**

E-mail: »dominik.kraut@mercedes-benz.com«

STM-867527
STLH-2696D **Small Parts Optimization (KTO)**

E-mail: »tobias.raible@mercedes-benz.com«

STM-867531
STLH-1507D **Logistics**

E-mail: »sebastian.s.fritz@mercedes-benz.com«

STM-867529
STLH-1506E **Materials Purchasing**

E-mail: »martin.backhaus@mercedes-benz.com«

STM-867528
STLH-3950A **Assembly Planning**

E-mail: »fabian.bross@mercedes-benz.com«

STM-867530
STLH-2697E **Test Equipment (Geometry)**

E-mail: »maik.schneider@daimler.com«

<p>Mercedes-Benz - Confidential -</p>	<p><small>Schutzvermerk DIN ISO 16016 beachten! / Refer to protection notice DIN ISO 16016! Keine Aenderung ohne Zustimmung der federfuehrenden Konstruktion / Any alterations are subject to the approval of the design department</small></p> <p>Technical Component Requirement Specifications Tail lamp QEV 111 AJPNLG</p>	<p>Bearb./auth.: Hans Peter Schiffert Abt./dep.: RD/KEL Datum/date: 2022-07-25 Requirement Specifications 001 version: Seite/page: 195 of 220</p>
---	---	---

3411510
STLH-2698A

Vehicle E/E wiring harness interface

E-mail: »volker.krieger@mercedes-benz.com«

3411514
STLH-2698A

E/E body controller interface

E-mail: »melanie.hawliczek@mercedes-benz.com«

3411515
STLH-2698A

External light control interface

E-mail: »ernst.maier@mercedes-benz.com«

STM-867534
STLH-1504C

Quality Management

E-mail: »alexander.b.meier@mercedes-benz.com«

3411516
STLH-2698A

Tolerance Management

E-mail: »matthias.wacker@mercedes-benz.com«

3411518
STLH-2698A

EMVE email interface

E-mail: »hakan.uluc@mercedes-benz.com«

STM-867535
STLH-4199A

Tool Specification for Prototype Parts

E-mail: »marcel.brenner@mercedes-benz.com«

STM-867537
STLH-5387A

Functional Safety

E-mail: »ernst.maier@mercedes-benz.com«

3.2

Project Responsibilities (STM-867533)

STM-867536
STLH-15E

The contractor shall maintain an "open points" list, to include a measure tracking system. On request, the contractor shall allow the client to inspect the open points list and the measure tracking system. On request, the contractor shall provide the scopes relevant to the client once or at intervals to be defined (e.g. weekly) to the client in electronic form.

STM-867542
STLH-5419A

The contractor shall designate a project manager for the project who shall coordinate and monitor the processes within the contractor's organization and act as the interface to the client.

<p>Mercedes-Benz - Confidential -</p>	<p><small>Schutzvermerk DIN ISO 16016 beachten! /Refer to protection notice DIN ISO 16016! Keine Aenderung ohne Zustimmung der federfuehrenden Konstruktion / Any alterations are subject to the approval of the design department</small></p> <p>Technical Component Requirement Specifications Tail lamp QEV 111 AJPNLG</p>	<p>Bearb./auth.: Hans Peter Schiffert Abt./dep.: RD/KEL Datum/date: 2022-07-25 Requirement Specifications 001 version: Seite/page: 196 of 220</p>
---	--	---

STM-867540
STLH-67B

Which project partner assumes which responsibilities in the project is defined in the following list.

STM-867538
STLH-4400D

The following designations are used in the responsibilities list.

Abbreviation	Description
I = information	It is absolutely essential that the partner concerned be informed by the party responsible about any changes or new results
C = cooperation	Provision of appropriate support for the party responsible on request by one or more of the companies involved in the project
A = acceptance	The partner concerned shall accept the result or decision-making basis
C/A = check & approve	Checking/approval of results or decision-making bases
R = responsibility/ execution	Is responsible for the provision of the services for providing results or the facts of the decision

STM-867541
STLH-1512D

Parts history

Client: A, I
Contractor: R

STM-867543
STLH-1513D

Process [FMEA](#)

Client: C/A, I
Contractor: R

STM-867546
STLH-1514D

Product [FMEA](#)

Client: C/A, I
Contractor: R

STM-867547
STLH-5388B

Functional safety

Client: C/A, A
Contractor: R

STM-2855896

The following rules apply for development cooperation in the event of a system breakup (tier n is specified by client).
A,C,K = Directed part type as per directed part identifier according to the system agreement from the Source Package (A = standard)

Item	Description	Client			Tier 1			Tier n		
		A	C	K	A	C	K	A	C	K
1	Creation and release of deadlines, milestones, target corridors, functional scopes, quality standards, dimensional specifications, data records for the tier-n scope	V	V	V	I	I	I	C	C	C
2	Design engineering responsibility for	A	A	A, C	V	V	V	C	C	I

Mercedes-Benz - Confidential -	<small>Schutzvermerk DIN ISO 16016 beachten! /Refer to protection notice DIN ISO 16016! Keine Aenderung ohne Zustimmung der federfuehrenden Konstruktion / Any alterations are subject to the approval of the design department</small> Technical Component Requirement Specifications Tail lamp QEV 111 AJPNLG	Bearb./auth.: Hans Peter Schiffert Abt./dep.: RD/KEL Datum/date: 2022-07-25 Requirement Specifications 001 version: Seite/page: 197 of 220
---	---	---

	the overall tier-1 function (incl. tier-n scope)									
3	Design engineering responsibility for the function of the tier-n scope (= directed part)	A	A	V	C	C	C	V	V	C
4	Creation and approval of specifications and requirement specifications for tier-n scope	V	V	V	C	C	I	C	C	C
5	Responsibility for tier-n component, functional properties in accordance with the stipulations of the requirement specifications	-	-	V	-	-	I	V	V	C
6	Responsibility for achieved performance: Integration (installability) of tier-n scope into tier-1 scope	C	A	A, C	V	V	V	C	C	I
7	Function testing of tier-n scope in accordance with the stipulations of the requirement specifications	A	A	V	V	I	I	C	V	C
8	Tier-1 responsibility for the tier-n scope regarding quality characteristics (e.g. gap dimensions)	A	A	V	V	V	I	C	C	C
9	Responsibility for the tier-1 scope (incl. overall tolerances and interaction with vehicle)	C/A, A	C/A, A	A	V	V	V	I	I	I
10	Commissioning and payment of prototype parts & tools for client incl. tier-n scopes The criterion is the receipt of tier-n scope goods by the client	V	V	V	-	-	-	I	I	I
11	Provision of trial parts, tools, jigs and fixtures for meeting the component requirement specifications & function specifications (LEK-E content) incl. tier-n scopes (in line with DC Calc) The criterion is no receipt of tier-n scope goods at the client	A	A	A	V	V	V	I	I	C
12	Change management for the tier-n scope. Important: Changes may also	A	A	V	V	C	C, I	C	V	C

Mercedes-Benz - Confidential -	<small>Schutzmerk DIN ISO 16016 beachten! /Refer to protection notice DIN ISO 16016! Keine Aenderung ohne Zustimmung der federfuehrenden Konstruktion / Any alterations are subject to the approval of the design department</small>	Bearb./auth.: Hans Peter Schiffert Abt./dep.: RD/KEL Datum/date: 2022-07-25 Requirement Specifications version: 001 Seite/page: 198 of 220
	Technical Component Requirement Specifications Tail lamp QEV 111 AJPNLG	

	be necessary in the tier-1 scope									
13	Change management for tier-1 scope	A	A	A	V	V	V	I	I	I
14	Performance of design FMEA for tier-n scope (if required)	I	A	V	A	I	I	V	V	C
15	Performance of design FMEA for tier-1 scope incl. tier-n scope	A	A	A	V	V	V	-	-	C
16	Execution of the issue resolution process for tier 1 including tier-n scope (= component part) in the case of flaws in design engineering	A	A	A, C	V	V	V	C	C	I
17	Execution of the issue resolution process for tier-n scope in the case of flaws in design engineering	A	A	V	V	I	I	C	V	I

3.3 Requirements Pertaining to Development-Related Services (STM-867548)

- STM-867551
STLH-6438A Requirements pertaining to the deployment of contractor staff at the client's operations for work that is not specifically related to the contract are void. The costs thereof shall not be included in the quotation submitted by the contractor. The contractor shall explicitly reject such requirements.
- STM-867550
STLH-4659 The following section describes tasks that shall be performed by the contractor as part of the development of the scope specified in these requirement specifications.
- STM-867549
STLH-4661 Specification of a response time means that the contractor, following receipt of the facts of the situation from the client, shall be able to carry out the described task or to begin processing by no later than the end of the required response time.
- STM-867552
STLH-4662 Specification of a processing time means that the contractor, following receipt of the facts of the situation from the client, shall have fully completed the given task within the given processing time.
- STM-867555
STLH-4663 In cases where a processing time is given but the contractor is not able to complete the task within the requirement processing period, the contractor shall provide prompt notification of this to the client.
- STM-867553
STLH-4664A The communication of problems or feedback on results shall often be done using vehicle parts or measuring equipment located on the premises of the client. For the following tasks, it shall be ensured that communication can take place on the premises of the client.
The contractor shall conduct fault analyses (e.g. vehicle measurements).
Response time: »One workday«
- STM-867554
STLH-4665C The contractor shall identify faulty components that are part of the overall system.
Response time: »One workday«
- STM-867556
STLH-4667A

Mercedes-Benz - Confidential -	<small>Schutzvermerk DIN ISO 16016 beachten! /Refer to protection notice DIN ISO 16016! Keine Aenderung ohne Zustimmung der federfuehrenden Konstruktion / Any alterations are subject to the approval of the design department</small>	Bearb./auth.: Hans Peter Schiffert Abt./dep.: RD/KEL Datum/date: 2022-07-25 Requirement Specifications version: 001 Seite/page: 199 of 220
	Technical Component Requirement Specifications Tail lamp QEV 111 AJPNLG	

STM-867558
STLH-4668A

The contractor shall participate in/carry out the detection and description of faulty performance, in particular in cases of failures in the field, in such a way that the fault can be processed in an optimum manner using the contractor's procedures.

Response time: »One workday«

STM-867561
STLH-4669B

The contractor shall participate in/carry out the execution of vehicle campaigns/vehicle updates aimed at the elimination of identified faults by the client's workshops.

Response time: »One workday«

STM-867559
STLH-4670B

The contractor shall participate in and/or execute board tests and system/vehicle integration tests, including EMC vehicle tests.

Response time: »One workday«

STM-867563
STLH-4674A

For scopes under the contractor's charge, the contractor shall perform data input for the client's data systems. The following systems shall be considered in detail:

- Certus
- DuKe
- PIA
- START
- ProCure
- ProSource

STM-867566
STLH-4676A

Coding for EPDM (for component data, especially pinning).

Response time: »One workday«

3.4

Protection Requirements When Handling Vehicles and/or Components Before the Press Announcement Day (PAD) (STM-2855915)

STM-2855916

If the services described in these requirement specifications necessitate the handling of vehicles and/or components by the contractor and/or subcontractor of the contractor before the respective PAD, the contractor shall comply with the "minimum requirements for prototype protection for third parties (incl. suppliers)" or demonstrate a TISAX certification with the additional module "prototype protection".

The current version can be obtained via the Supplier Portal:

<https://docmaster.supplier.daimler.com/DMPublic/en/> > General Supplier Documents

<p>Mercedes-Benz - Confidential -</p>	<p style="font-size: small;">Schutzvermerk DIN ISO 16016 beachten! /Refer to protection notice DIN ISO 16016! Keine Aenderung ohne Zustimmung der federfuehrenden Konstruktion / Any alterations are subject to the approval of the design department</p> <p style="text-align: center;">Technical Component Requirement Specifications Tail lamp QEV 111 AJPNLG</p>	<p>Bearb./auth.: Hans Peter Schiffert Abt./dep.: RD/KEL Datum/date: 2022-07-25 Requirement Specifications version: 001 Seite/page: 200 of 220</p>
---	---	---

4 Deadlines, Tools and Components in the Development Process (STM-867573)

4.1 Data Provision and Release Deadlines for Documentation Maturity Levels (STM-867577)

- STM-867579
STLH-951
Within the product creation process, adherence to the following data provision deadlines and documentation maturity level releases is required. The contractor shall deliver the data records in appropriate quality by the provision dates specified in the Excerpt from the Process Master Plan for Suppliers. For requirements pertaining to the data format to be used, see Chapter "Documentation" STLH-2718.
- STM-867581
STLH-6968
The contractor shall have transferred the required data records on the respective digital prototype (DPT) phases to the client in an initial engineering status by the [MDS](#) milestone "Data provision stage I".
- STM-867578
STLH-6969A
The contractor shall have transferred the required design and function data on the respective digital prototype (DPT) phases to the client in a fully designed status by the [MDS](#) milestone "Data provision stage II" (data freeze).
- STM-867580
STLH-6970A
During the contractual relationship, the contractor shall provide validation-relevant changes (e.g. location, 3D geometry, material) in digital form at the latest 2 weeks after the change request.
- STM-867582
STLH-6971A
The contractor shall have handed over the required data records for the releases "P" (only for vehicle projects), "W", and "_" 20 workdays before the respective component-specific deadlines for "Start of workflow" (P, W, _). The deadlines shall be taken from the component schedule.
- STM-2101326
STLH-7562
All data records provided shall contain the correct weights and centers of gravity according to the current state of development.
- STM-867585
STLH-3024H
A detailed definition of the data provision deadlines and documentation maturity levels is described in Chapter "Product Data Management" in the document [\[LHV 310.00x\]](#) under Requirement ID CRQ-292.
- STM-867584
STLH-3025D
If necessary, the deadlines will be updated by the client during plan scheduling.

4.2 Tools and Components in the Development Process (RD Requirements) (STM-867583)

4.2.1 General Requirements (STM-867587)

- STM-867586
STLH-2702D
Following receipt of an order, the contractor shall supply all components to the client on the agreed delivery dates.

Mercedes-Benz - Confidential -	<small>Schutzvermerk DIN ISO 16016 beachten! / Refer to protection notice DIN ISO 16016! Keine Aenderung ohne Zustimmung der federfuehrenden Konstruktion / Any alterations are subject to the approval of the design department</small>	Bearb./auth.: Hans Peter Schiffert Abt./dep.: RD/KEL Datum/date: 2022-07-25 Requirement Specifications 001 version: Seite/page: 201 of 220
	Technical Component Requirement Specifications Tail lamp QEV 111 AJPNLG	

STM-867592
STLH-3953G

Regarding the requirements pertaining to the components and their implementation, the contractor shall coordinate with the client's development manager in a timely manner. For general requirements related to the sample statuses, see Chapter "Sample Statuses" in the document [\[LHV 310 00x\]](#) under the Requirement ID CRQ-75.

STM-867589
STLH-1395F

If concrete unit numbers are specified in this chapter, the stated quantities are to be understood as guideline values and apply subject to further additions and/or separate orders. The demand assessment shall apply. The contractor will be informed by the client's development engineer in good time of the delivery date and implementation of the component ([hardware](#) release, [software](#) release, etc.) and the FINAS number assigned to the sample part (for tracing the sample part on the client's premises during the development phase). FINAS is the client's vehicle and test parts information and administration system.

STM-867590
STLH-1401B

Prices for parts and tools apply only to scopes meeting all requirements with regard to function and feasibility. In case of non-adherence, the contractor shall immediately supply a free replacement. This applies until the part has been shown to comply.

STM-867588
STLH-3027B

The contractor shall coordinate with the client's development manager as regards the requirements pertaining to the parts for validating the testworthiness during the respective development phases.

STM-867591
STLH-1396F

The commissioning of components as part of the development process is usually performed by the RD Logistics unit and may vary from the series production ordering process. The exact quantity per ordering window is also defined here.

STM-867594
STLH-1397G

If the order is place by the RD Logistics area, the contractor shall always deliver with a delivery note and complete parts labeling in accordance with [\[MTCSPEC\]](#) via the unloading point specified in the order.

STM-867595
STLH-1398E

With regard to electronic ordering and supply agreements, corresponding preparations must be made by the contractor. More detailed information is available at: <https://supplier-portal.daimler.com/portal/de> or by email to befo_info@mercedes-benz.com.

4.2.2 Tool Concept and Controlling (2831619)

4.2.3 Delimitation of Sample Parts (STM-867593)

STM-867596
STLH-5612E

In the development process, sample parts produced by means of prototype tools or processes (prototype parts) are usually required before the [AVeh](#) phase (vehicles) or null series (powertrain). Starting with the [AVeh](#) phase or null series (powertrain), components produced using production tools (possibly (first) [off-standard-tool parts](#)) shall be used (cf. [\[MBST\]](#) 37/05).

The maturity-level-dependent definition of the sample statuses can be found, among other things, in the Set of Assumptions Concerning RD Hardware Requirements [\[MGU00001711\]](#).

STM-2101327
STLH-7563

For components from the production tool, the measured weights of the single parts and [ZB](#) that match the weights documented in Smaragd/DIALOG shall be delivered to

Mercedes-Benz - Confidential -	<small>Schutzvermerk DIN ISO 16016 beachten! /Refer to protection notice DIN ISO 16016! Keine Aenderung ohne Zustimmung der federfuehrenden Konstruktion / Any alterations are subject to the approval of the design department</small>	Bearb./auth.: Hans Peter Schiffert Abt./dep.: RD/KEL Datum/date: 2022-07-25 Requirement Specifications version: 001 Seite/page: 202 of 220
	Technical Component Requirement Specifications Tail lamp QEV 111 AJPNLG	

the client.

STM-2101328
STLH-7564

The following deviations between the measured and calculated weights are permissible:

Weight --> Maximum deviation in %

$X < 1 \text{ g} \rightarrow 100 \%$

$1 \text{ g} \leq X < 100 \text{ g} \rightarrow 10 \%$

$100 \text{ g} \leq X < 1 \text{ kg} \rightarrow 5 \%$

$1 \text{ kg} \leq X < 10 \text{ kg} \rightarrow 2 \%$

$10 \text{ kg} \leq X < 100 \text{ kg} \rightarrow 1 \%$

$X \geq 100 \text{ kg} \rightarrow 0.5 \%$

4.2.4 Sample Parts in the Development Process (STM-867597)

STM-867599
STLH-5614C

The highest possible available maturity level shall generally always be provided. If (first) [off-standard-tool parts](#) are not available prior to the [AVeh](#) phase or null series, the requirements for these scopes will be produced using prototypes following consultation with the client's department.

4.2.4.1 Sample and Delivery Dates (2831621)

4.2.4.2 Tool Specification for Sample Parts (STM-867598)

STM-867600
STLH-2708C

Sample parts from prototype tools shall generally be manufactured using series production material. Potential benefits of using alternative materials, or of applying rapid prototyping or rapid tooling processes, shall be taken into consideration in coordination with the client.

STM-867601
STLH-2709E

Prototype tools shall be of simple design and suited to the client's quantity requirements.

A tool technology of maximum possible cost efficiency shall always be offered.

STM-867602
STLH-2710C

For the construction of prototype tools and jigs and fixtures, the contractor shall wherever possible use existing, standard elements (e.g. master molds, standard profiles, etc.) that remain the contractor's property.

STM-867605
STLH-2711B

The contractor shall check the possibility of bringing the series production tool forwards. In the event of changes, additional costs shall be covered through the change management system and the contractor shall account for and include these costs in the quotation early on at the time of the change request assessment.

STM-867604
STLH-2713B

In line with the above-mentioned component requirements and the excerpt from the project master plan, (first) [off-standard-tool parts](#) shall be provided by the contractor in good time. The specification for this corresponds to series production specifications as per [\[MBST\]](#).

Deviations from these are only permitted in coordination with the client and with the explicit approval of the client's QM.

Mercedes-Benz - Confidential -	<small>Schutzvermerk DIN ISO 16016 beachten! / Refer to protection notice DIN ISO 16016! Keine Aenderung ohne Zustimmung der federfuehrenden Konstruktion / Any alterations are subject to the approval of the design department</small>	Bearb./auth.: Hans Peter Schiffert
	Technical Component Requirement Specifications Tail lamp QEV 111 AJPNLG	Abt./dep.: RD/KEL Datum/date: 2022-07-25 Requirement Specifications version: 001 Seite/page: 203 of 220

4.2.4.3 Sourcing of Prototype Tools and Sample Parts (STM-867603)

STM-867607
STLH-132D

The prices of prototype tools and sample parts shall be defined between the contractor and the client in separate agreements.

STM-867606
STLH-1399J

The Set of Assumptions Concerning RD Hardware Requirements [\[MGU00001711\]](#) apply for the sourcing of sample component parts and prototype tools and of the associated jigs and fixtures as part of the requested sourcing scope. These shall be verified by the contractor's signature and provided to the client.
If [STLH-5615](#) contains no specific requirements pertaining to sample part prices and, where applicable, prototype tool and jig/fixture costs, the contractor shall present the detailed specifications and costs (see Table "Cost Overview Sheet for Prototype Tools and Sample Parts"; the MS Excel template shall be obtained through the "proSource" system). Deviations from these specifications shall be coordinated by the contractor with the client and shall be offered as options.

STM-867610
STLH-5421G

The corresponding contents of the general RFQ documents apply to the sourcing of prototype tools and sample parts, as described below. Excerpt from the general RFQ documents:

"... test tools are all jigs, fixtures, and tools required to create test parts. This term also includes all auxiliary and prototype tools plus preproduction tools. The client will directly reimburse the costs for the test tools. The client reserves the right to negotiate test tool and part costs directly with the prototype manufacturer (tier 2, ...) and to pay them directly. The system/development supplier (tier 1) is obliged to provide logistical and technical support for the test tools/parts. As part of the development order, the client grants the development supplier the right of access to the tools and the related expertise at all times. ..."

Further information on direct sourcing can be found in [\[MGU00001711\]](#).

4.2.4.4 Pricing of Sample Parts (STM-867612)

STM-867609
STLH-5616E

All sample component parts shall as a rule be offered on a graduated scale according to maturity level. See the specifications in [\[MGU00001711\]](#).

The sample parts prices negotiated shall become binding with the award of the contract. They shall apply for all orders placed by the client regardless of the intended purpose and place of delivery.

In the event that parts from other model series or projects are used which already have a higher maturity level or development status (e.g.(first) [off-standard-tool parts](#)), the conditions agreed for the original model series or original project shall apply.

During the duration of the project phases [after veh.](#) and [confirmation vehicle](#), the series production prices (total prices) valid at this point in time at the latest shall apply to [off-standard-tool parts](#). This shall apply for all orders placed by the client in these project phases regardless of the intended purpose and place of delivery.

STM-867608
STLH-5645A

All costs (e.g. setup, measuring, packaging, shipping, handling, etc.) incurred up to and including delivery to the receiving locations specified by the client shall be covered by the cost of the sample parts as negotiated.

STM-867611
STLH-5423C

If corresponding sample prices or factor rates for the series-production price as well as possibly required prototype tool costs are specified in the following table "Fixed

Mercedes-Benz - Confidential -	<small>Schutzvermerk DIN ISO 16016 beachten! /Refer to protection notice DIN ISO 16016! Keine Aenderung ohne Zustimmung der federfuehrenden Konstruktion / Any alterations are subject to the approval of the design department</small>	Bearb./auth.: Hans Peter Schiffert Abt./dep.: RD/KEL Datum/date: 2022-07-25 Requirement Specifications version: 001 Seite/page: 204 of 220
	Technical Component Requirement Specifications Tail lamp QEV 111 AJPNLG	

prices", the contractor shall take these over into its offer and enter corresponding validity periods.

STM-867614
STLH-3028

Table: Fixed prices

STM-867616
STLH-3029A

Designation	From off-tool parts	From off-standard-tool parts
Tail lamp	1 times series production price	1 times series production price

Designation	Variant	Fixed price (if necessary)
Illumination engineering test fixture for rear lamps	1 set of sidewall lamps (LH/RH)	€2,300
Illumination engineering test fixture for rear lamps	1 x Trunk lid lamp (continuous reflector strip)	€3,500
Illumination engineering test fixture for rear lamps	1 x set Trunk lid lamp (LH/RH)	€3,000
Illumination engineering test fixture for rear shaker lamps	1 set of sidewall lamps (LH/RH)	€5,000
Illumination engineering test fixture for rear shaker lamps	1 x Trunk lid lamp (continuous reflector strip)	€7,000
Illumination engineering test fixture for rear shaker lamps	1 x set Trunk lid lamp (LH/RH)	€4,000
Illumination engineering test fixture for rear shaker lamps	1 x set Trim strip	€3,400

4.2.4.5

Quantities for Components (STM-867613)

STM-867615
STLH-5618B

The quantities given here are to be interpreted as guideline values and apply subject to further additions and/or separate orders. The demand assessment shall apply. For general deadlines, see "Excerpt from the Process Master Plan for Suppliers".

STM-867617
STLH-5619A

Quantity forecast:

STM-867621
STLH-5620

Sample status	Quantity	Intended use/phase
A-sample	...	e.g. test bench
B-sample	...	E.g. TVeh phase
C-sample	...	E.g. AVeh phase
D-sample	...	E.g. CVeh phase

4.2.5

PPA Sampling (STM-867618)

STM-867620
STLH-3958J

The contractor shall provide the samples with a [PPA](#) report (PPAR) for sampling to the client as per [\[MBST\]](#) by the following deadline: »8 weeks« before the [MDS](#) milestone "Delivery of assembly parts for production test 1" (see: "Excerpt from the

Mercedes-Benz - Confidential -	<small>Schutzvermerk DIN ISO 16016 beachten! /Refer to protection notice DIN ISO 16016! Keine Aenderung ohne Zustimmung der federfuehrenden Konstruktion / Any alterations are subject to the approval of the design department</small> Technical Component Requirement Specifications Tail lamp QEV 111 AJPNLG	Bearb./auth.: Hans Peter Schiffert Abt./dep.: RD/KEL Datum/date: 2022-07-25 Requirement Specifications 001 version: Seite/page: 205 of 220

Process Master Plan for Suppliers")

STM-867619
STLH-5417

The PPA report deadline may be updated by the client as part of plan scheduling.

STM-867622
STLH-5547A

The contractor shall report back the PPA report deadlines in the "start" system (see [\[LHV 310 00x\]](#) under the Requirement ID CRQ-2759). Before reporting back, the contractor shall coordinate the deadlines with the client's responsible quality engineer.

STM-867626
STLH-5548

The contractor shall take part in sampling coordination talks in a timely manner prior to the scheduled deadline. Here, the cornerstones of the sampling process will be defined.

4.3

E/E Maturity Level Management (STM-2100431)

STM-2100432
STLH-7555

Component development takes place in a release-based manner.

STM-2100436
STLH-7556

The deadlines for the main release (".0 Releases") can be found in the "Excerpt from the Process Master Plan for Suppliers". There is, in each case, a further interim release (".1 Release") in between.

STM-2100437
STLH-7557

The planning of the scopes that are required per release is realized in two release plans, namely the FROP (Feature Rollout Plan) that describes the assignment of the required functions to the individual releases, as well as a BROP (Basic Technology Rollout Plan) that describes the assignment of the required basis technology to the individual releases.

STM-2100438
STLH-7558

The FROP is component-specific and made available as an Excel spreadsheet. The BROP applies uniformly to all components and is described in the other applicable document [\[MSS 30003\]](#) and in the Chapter "Basic Driving Functions" (STLH-6229).

STM-2100439
STLH-7559

If a test suite is referenced in BROP [\[MSS 30003\]](#), the contractor is obliged to hand over the results of the test suite together with the respective release status.

STM-2100440
STLH-7560

In accordance with the requirements in section CRQ-1787 in the document [\[LHV 310 001\]](#), the contractor is obliged to adopt the requirements from the FROP and BROP in its release planning and to immediately notify the client of any deviations.

STM-2100441
STLH-7561

Six weeks before the respective release deadline, the contractor shall inform the client of the expected maturity level of the scopes required for the release deadline.

Mercedes-Benz - Confidential -	<small>Schutzvermerk DIN ISO 16016 beachten! / Refer to protection notice DIN ISO 16016! Keine Aenderung ohne Zustimmung der federfuehrenden Konstruktion / Any alterations are subject to the approval of the design department</small>	Bearb./auth.: Hans Peter Schiffert
	Technical Component Requirement Specifications Tail lamp QEV 111 AJPNLG	Abt./dep.: RD/KEL Datum/date: 2022-07-25 Requirement Specifications version: 001 Seite/page: 206 of 220

5 Documentation (STM-867623)

STM-867624
STLH-16C

The contractor shall continuously document the development status of the scope of supply as specified in the requirements given here. On request, the contractor shall allow the client to inspect this documentation.

STM-867627
STLH-6815

The contractor shall prepare thorough and comprehensive documentation of the scope of supply and services described in these requirement specifications. This shall comply with all legislation, regulations and technical standards applicable to the full performance or to partial performances.

STM-867625
STLH-6816

The contractor shall deliver the technical documentation at the latest upon acceptance by the client of the work/services rendered. If requested to do so prior to acceptance, the contractor shall deliver completed sections of the technical documentation covering both the full performance or individual performance units.

STM-867631
STLH-6817

Prior to acceptance of the full performance or of any one performance unit, the client can demand to examine the methods, systematics and internal processes that the contractor used or will use to produce the technical documentation.

5.1 Special Features (Part 1) – Safety-Relevant Features (DS) (STM-867628)

STM-867629
STLH-5955

As it currently stands, DS identification on the drawings or in the documentation systems is not compulsory for this component. If [DS](#) features prove to be relevant for documentation for the client or the contractor during the course of development, the type and time of identification shall be agreed on and documented in a written agreement – more detailed instructions will be issued in this respect if required.

5.2 Special Features (Part 2) – Certification-Relevant Characteristics ([DZ](#)) (STM-2100464)

5.2.1

Implementation of Certification Relevant Characteristics (STM-2100466)

STM-2100467
STLH-7569

This component is subject to obligatory identification and documentation with regard to certification relevance (incl. emissions relevance) with [DZ](#) at the drawing level and in the documentation systems as per Chapter "Certification-relevant characteristics ([DZ](#))" in the document [\[LHV 310 00x\]](#) under Requirement ID CRQ-3836.

STM-867634
STLH-5544B

Furthermore, the contractor shall take into account the general certification requirements (e.g. CCC = China Compulsory Certification) in Chapter "Laws, Standards and Regulations" of the document [\[LHV 310 00x\]](#) under Requirement ID CRQ-313 (see [\[MBN 10317-2\]](#) also).

<p>Mercedes-Benz - Confidential -</p>	<p style="font-size: small;">Schutzvermerk DIN ISO 16016 beachten! / Refer to protection notice DIN ISO 16016! Keine Aenderung ohne Zustimmung der federfuehrenden Konstruktion / Any alterations are subject to the approval of the design department</p> <p style="text-align: center;">Technical Component Requirement Specifications Tail lamp</p> <p style="text-align: center;">QEV 111 AJPNLG</p>	<p>Bearb./auth.: Hans Peter Schiffert Abt./dep.: RD/KEL Datum/date: 2022-07-25 Requirement Specifications 001 version: Seite/page: 207 of 220</p>
--	--	---

The following list shows further subdivisions and the corresponding [DZ](#) characteristics, which are to be identified for the client in accordance with [\[MBN 10317-0\]](#) and [\[MBN 10317-2\]](#). Multiple items may be named.

3128873

Serial no.	Specialist area	Characteristic name	Market (as per ISO 3166)	Specification
DZ 1	Illumination – lamp in general	Reference point	CAN;CHN; ECE;USA	CMVSS 108;CNCA-C11-07;ECE-R3/6/7/19/23/38/77/87/91..;FMVSS 108
DZ 2	Illumination – lamp in general	Area	CAN;CHN; ECE;USA	CMVSS 108;CNCA-C11-07;ECE-R3/6/7/19/23/38/77/87/91..;FMVSS 108
DZ 3	Illumination – lamp in general	Restriction of the light emission area top/bottom/ inside/outside	CAN;CHN; ECE;USA	CMVSS 108;CNCA-C11-07;ECE-R3/6/7/19/23/38/77/87/91..;FMVSS 108
DZ 4	Illumination – lamp in general	Manufacturer/trade mark	CAN;CHN; ECE;USA	CMVSS 108;CNCA-C11-07;ECE-R3/6/7/19/23/38/77/87/91..;FMVSS 108
DZ 5	Illumination – lamp in general	Lamp model designation	CAN;CHN; ECE;USA	CMVSS 108;CNCA-C11-07;CNCA-C11-01;ECE-R3/6/7/19/23/38/77/87/91..;FMVSS 108
DZ 6	Illumination – lamp in general	Lamps-illuminant category	CAN;CHN; ECE;USA	CMVSS 108;CNCA-C11-07;CNCA-C11-01;ECE-R3/6/7/19/23/38/77/87/91..;FMVSS 108
DZ 7	Illumination – lamp in general	Electrical Key Data	CAN;CHN; ECE;USA	CMVSS 108;CNCA-C11-07;ECE-R3/6/7/19/23/38/77/87/91..;FMVSS 108
DZ 8	Lighting - outer edges	Satisfaction of ECE radii requirements by outer edges	ECE	ECE-R 26
DZ 9	Illumination – backup lamp	Self-declaration (CCC approval mark)	CHN	CNCA Announcement 44 (2019)

Mercedes-Benz - Confidential -	<small>Schutzvermerk DIN ISO 16016 beachten! /Refer to protection notice DIN ISO 16016! Keine Aenderung ohne Zustimmung der federfuehrenden Konstruktion / Any alterations are subject to the approval of the design department</small> Technical Component Requirement Specifications Tail lamp QEV 111 AJPNLG	Bearb./auth.: Hans Peter Schiffert Abt./dep.: RD/KEL Datum/date: 2022-07-25 Requirement Specifications version: 001 Seite/page: 208 of 220

DZ 10	Illumination – backup lamp	Voluntary certificate	CHN	CNCA Announcement 44 (2019)
DZ 11	Illumination – backup lamp	ECE approval mark (E no.)	ECE	ECE-R 23; ECE-R 148
DZ 12	Illumination – backup lamp	SAE approval mark (DOT no.)	CAN;USA	CMVSS 108;FMVSS 108
DZ 13	Illumination – reflector	Voluntary certificate	CHN	CNCA Announcement 29 (2018)
DZ 14	Illumination – reflector	ECE approval mark (E no.)	ECE	ECE-R 3; ECE-R 150
DZ 15	Illumination – reflector	SAE approval mark (DOT no.)	CAN;USA	CMVSS 108;FMVSS 108
DZ 16	Illumination – rear fog lamp	Self-declaration (CCC approval mark)	CHN	CNCA Announcement 44 (2019)
DZ 17	Illumination – rear fog lamp	Voluntary certificate	CHN	CNCA Announcement 44 (2019)
DZ 18	Illumination – rear fog lamp	Variable luminous intensities	CHN;ECE	CNCA-C11-07, GB 11554; ECE-R 38; ECE-R 148
DZ 19	Illumination – rear fog lamp	ECE approval mark (E no.)	ECE	ECE-R 38; ECE-R 148
DZ 20	Illumination – rear fog lamp	SAE approval mark (DOT no.)	CAN;USA	CMVSS 108;FMVSS 108
DZ 21	Illumination – direction indicator	Self-declaration (CCC approval mark)	CHN	CNCA Announcement 44 (2019)
DZ 22	Illumination – direction indicator	Voluntary certificate	CHN	CNCA Announcement 44 (2019)
DZ 23	Illumination – direction indicator	Variable luminous intensities	CHN;ECE	CNCA-C11-07, GB 17509; ECE-R 6; ECE-R 148
DZ 24	Illumination – direction indicator	ECE approval mark (E no.)	ECE	ECE-R 6; ECE-R 148
DZ 25	Illumination – direction indicator	SAE approval mark (DOT no.)	CAN;USA	CMVSS 108;FMVSS 108

Mercedes-Benz - Confidential -	Schutzvermerk DIN ISO 16016 beachten! /Refer to protection notice DIN ISO 16016! Keine Aenderung ohne Zustimmung der federfuehrenden Konstruktion / Any alterations are subject to the approval of the design department	Bearb./auth.: Hans Peter Schiffert Abt./dep.: RD/KEL Datum/date: 2022-07-25 Requirement Specifications 001 version: Seite/page: 209 of 220
	Technical Component Requirement Specifications Tail lamp QEV 111 AJPNLG	

DZ 26	Illumination – brake/tail lamps	Self-declaration (CCC approval mark)	CHN	CNCA Announcement 44 (2019)
DZ 27	Illumination – brake/tail lamps	Voluntary certificate	CHN	CNCA Announcement 44 (2019)
DZ 28	Illumination – brake/tail lamps	Variable luminous intensities	CHN;ECE	CNCA-C11-07, GB 5920; ECE-R 7; ECE-R 148
DZ 29	Illumination – brake/tail lamps	ECE approval mark (E no.)	ECE	ECE-R 7; ECE-R 148
DZ 30	Illumination – brake/tail lamps	SAE approval mark (DOT no.)	CAN;USA	CMVSS 108;FMVSS 108
DZ 31	Illumination – standing lights	Self-declaration (CCC approval mark)	CHN	CNCA Announcement 44 (2019)
DZ 32	Illumination – standing lights	Voluntary certificate	CHN	CNCA Announcement 44 (2019)
DZ 33	Illumination – standing lights	ECE approval mark (E no.)	ECE	ECE-R 77; ECE-R 148
DZ 34	Illumination – standing lights	SAE approval mark (DOT no.)	CAN;USA	CMVSS 108;FMVSS 108
DZ 35	Illumination – side marker lamps	Self-declaration (CCC approval mark)	CHN	CNCA Announcement 44 (2019)
DZ 36	Illumination – side marker lamps	Voluntary certificate	CHN	CNCA Announcement 44 (2019)
DZ 37	Illumination – side marker lamps	ECE approval mark (E no.)	ECE	ECE-R 91;ECE-R 148
DZ 38	Illumination – side marker lamps	SAE approval mark (DOT no.)	CAN;USA	CMVSS 108;FMVSS 108

STM-2100471
STLH-7571

The required standards are as follows:

STM-2100472
STLH-7572

[\[MBN 10317-0\]](#): CAD Drawings / 3D CAD Models – Identification of Parts, Assemblies, and Special Characteristics – Principles – Obligation to Component/Assembly Documentation

STM-2100473
STLH-7573

[\[MBN 10317-2\]](#): CAD Drawing / 3D CAD Models – Identification of Characteristics for Documented Evidence – Specific Specifications and Use Cases ([MBC](#), VAN

Mercedes-Benz - Confidential -	<small>Schutzvermerk DIN ISO 16016 beachten! /Refer to protection notice DIN ISO 16016! Keine Aenderung ohne Zustimmung der federfuehrenden Konstruktion / Any alterations are subject to the approval of the design department</small>	Bearb./auth.: Hans Peter Schiffert Abt./dep.: RD/KEL Datum/date: 2022-07-25 Requirement Specifications version: 001 Seite/page: 210 of 220
	Technical Component Requirement Specifications Tail lamp QEV 111 AJPNLG	

and Buses)

STM-2100470
STLH-7574

If, during the course of development (including further development during the series production phase) for the client or the contractor, further [DZ](#) features prove relevant for identification and documentation, the type and time of identification shall be coordinated and documented in writing in an agreement.

5.3 Vehicle Documentation in [VeDoc](#) for Passenger Cars (STM-867645)

STM-867643
STLH-5960

No data subject to compulsory documentation needs to be recorded for this component for traceability at the part level. If data subject to compulsory documentation in this sense arises during the course of development for the client or the contractor, the contractor shall coordinate the type and time of identification with the client and shall document these in writing in an agreement.

5.4 CAD product data and prerequisites for the IT connection (STM-867387)

STM-867383
STLH-3417G

General requirements pertaining to CAD product data are described in the document [\[LHV 310 00x\]](#) for these requirement specifications.

STM-867385
STLH-4630E

The current version of the client's CAD handbook for product description data, [\[CADHB\]](#), in short "CAD Handbook", is used as the content basis for requirements pertaining to the documentation of the CAD product data.

STM-867384
STLH-5556B

For the development of components, the client fundamentally accepts only the CAD data formats NX and JT/TIFF.
If the NX data built into the NX version specified by Mercedes-Benz can be delivered with its complete design history, this shall be preferred to JT data. If parametrics are not explicitly required, both nonparametric NX and JT/TIFF can be delivered.
The following sections specify the basic requirements pertaining to each of the CAD data formats used.

STM-867386
STLH-5600B

If the JT/TIFF and NX data formats in the form "CAD models without design history" are both requested, the contractor can select the data format to be delivered in coordination with the client.
Once selected, the data format may not be changed over the term of the contract.

STM-2100474
STLH-7549

The 3D geometry is available in the form of a solid. This is required in order to be able to use the 3D data in the client's follow-up and validation processes.

STM-867389
STLH-6850A

All CAD models for visible parts in the interior and exterior shall have texturing of the visible surfaces in accordance with the surface groups as per module CS136 "Digital Color Documentation" of the "CAD Handbook" [\[CADHB\]](#).
Contact for "Digital color documentation":
CAx support suppliers
E-mail: cax-support-suppliers@mercedes-benz.com

Mercedes-Benz - Confidential -	<small>Schutzvermerk DIN ISO 16016 beachten! / Refer to protection notice DIN ISO 16016! Keine Änderung ohne Zustimmung der federführenden Konstruktion / Any alterations are subject to the approval of the design department</small>	Bearb./auth.: Hans Peter Schiffert
	Technical Component Requirement Specifications Tail lamp QEY 111 AJPNLG	Abt./dep.: RD/KEL Datum/date: 2022-07-25 Requirement Specifications version: 001 Seite/page: 211 of 220

5.4.1 NX Data Format (STM-867388)

5.4.1.1 Generation of Data (STM-867392)

STM-867390
STLH-5451C

CAD models without a design history comply with all requirements for release at the client. They contain information such as mass properties, center of gravity, etc.

5.4.1.2 Prescribed Design Methodology (STM-867393)

STM-867397
STLH-5454C

Module CS082 of [\[CADHB\]](#) describes general procedures for working with NX. It contains references to the relevant NX design methods.

5.4.1.3 Scope of Data to Be Delivered (STM-867394)

STM-867400
STLH-2722F

Scope of delivery, assembly and a CAD model for each single part

2831816

One CAD model for environment-forming parts (housing, lens, fastening components, etc.) and one CAD model for design-forming parts (panels, reflectors incl. photometric surfaces, and electronic components, etc.).

STM-867404
STLH-2724C

Assembly drawing

5.4.1.4 Datum System of the CAD Models (STM-867406)

STM-867405
STLH-5563A

If a change is made to the component, it is not permitted to change the reference system.

STM-867407
STLH-5564

The CAD models are described with reference to a base coordinate system (engineering design in the installation position).

5.4.2 JT and TIFF Data Format (STM-867409)

5.4.2.1 Prescribed Preparation Methodology (STM-867411)

STM-867410
STLH-4689E

Module CS059 of [\[CADHB\]](#) describes general procedures for working with JT and TIFF

5.4.2.2 Scope of Data to Be Delivered (STM-867412)

STM-867413
STLH-4684D

Scope of delivery (assembly, upper most node is PLMXML, single parts available as JT, stored in Smaragd under an item number. PLMXML file shall be supplied by the contractor)

Mercedes-Benz - Confidential -	<small>Schutzvermerk DIN ISO 16016 beachten! / Refer to protection notice DIN ISO 16016! Keine Aenderung ohne Zustimmung der federfuehrenden Konstruktion / Any alterations are subject to the approval of the design department</small>	Bearb./auth.: Hans Peter Schiffert
	Technical Component Requirement Specifications Tail lamp QEV 111 AJPNLG	Abt./dep.: RD/KEL Datum/date: 2022-07-25 Requirement Specifications 001 version: Seite/page: 212 of 220

STM-867415
STLH-4686

TIFF assembly drawing

5.4.2.3

Datum System of the CAD Models (STM-867420)

STM-867419
STLH-5571A

If a change is made to the component, it is not permitted to change the reference system.

STM-867418
STLH-5572

The CAD models are described with reference to a base coordinate system (engineering design in the installation position).

5.4.3

Provided Installation Space Environment (STM-867422)

STM-867425
STLH-2245E

The client provides the contractor with CAD product description data. The contractor shall take account of the provided data when producing CAD models.

STM-867424
STLH-2254F

The contractor shall take account of the installation space and interfering geometries when producing CAD models.

STM-867426
STLH-4405D

The reference system (coordinate systems) of the supplied CAD models shall not be changed.

5.4.4

CAD Qualification (STM-867423)

STM-867427
STLH-1988I

Prior to the initial data interchange, the contractor shall provide verification of its CAD qualification for the required CAD data format (NX or JT/TIFF). The process has been specified in [\[CADHB\]](#), module CV001. Regular productive data interchange with the client may only take place once the contractor has verified its CAD qualification for the respective format.

5.4.5

Prerequisites for IT Integration (STM-867431)

STM-2100558
STLH-7536

If the service provision requires a connection to the client's IT landscape, the contractor shall be obliged to fully meet all prerequisites and conditions for this connection in good time before the first use or necessity for use of this connection and to maintain it without interruption throughout the entire period of service provision.

STM-2100576
STLH-7537

The following section lists the minimum prerequisites and conditions for setting up and maintaining such an IT connection. Any defined requirements and agreements that go beyond this can only increase, never decrease, the prerequisites and conditions for the contractor in each case. Other written agreements between the client and the contractor that increase the requirements for the contractor defined here also remain valid.

5.4.5.1

Qualification (STM-2100588)

STM-2100594
STLH-7539

The contractor shall ensure for all necessary applications that each user possesses the qualification required to perform the respective service. The required qualification

Mercedes-Benz - Confidential -	<small>Schutzvermerk DIN ISO 16016 beachten! /Refer to protection notice DIN ISO 16016! Keine Aenderung ohne Zustimmung der federfuehrenden Konstruktion / Any alterations are subject to the approval of the design department</small>	Bearb./auth.: Hans Peter Schiffert Abt./dep.: RD/KEL Datum/date: 2022-07-25 Requirement Specifications 001 version: Seite/page: 213 of 220
	Technical Component Requirement Specifications Tail lamp QEV 111 AJPNLG	

results from the general rules of the client on the use of an application and the additional special qualifications required by the client for performing the commissioned service.

STM-2100595
STLH-7540

This regulation also applies to applications that may have been agreed upon in writing between the client and the contractor in addition to the list shown below and to additional applications required by the contractor.

5.4.5.2 Contractual regulations and need for protection (STM-867436)

STM-2100610
STLH-7541

The contractor is obliged to comply with the Complementary Requirements for IT Information Security in the Development Environment [[ALD00001354](#)]. These can be publicly accessed in Daimler DocMaster via the Daimler Supplier Portal > Downloads > DocMaster Supplier Documents > General Supplier Documents > IT-Safety Requirements or can be requested from the commissioning department.

STM-2100611
STLH-7542

The contractor shall ensure that the requirements of the protection requirement class communicated by the client are met in full for any situation in the context of service provision. Compliance with the "Internal" protection requirement class is always a minimum requirement.

5.4.5.3 Network Connection to the Client's IT Network (STM-867438)

STM-2100632
STLH-7543

If the provision of the services requires a network connection to the client's IT network, the contractor shall ensure throughout the entire period of service provision that an appropriate and suitable network connection (business partner connection) is available without interruption and is fully functional for use by the contractor.

STM-2100633
STLH-7544

The contractor shall be responsible for ensuring that the freely available band width is sufficient for the requirements of service provision at all times.

5.4.5.4 Reporting Users to Be Deployed (STM-867441)

STM-867442
STLH-6941A

The contractor shall provide the client, at the latest one calendar month before the start of the planned service provision, with a complete list of the users who are to have access to the IT resources of the client as part of the assignment.

This list shall contain the following:

1. For those users already assigned a User ID:
 - User ID (Corporate or Active Directory User ID, "EMEA-ID") and
 - Supplier Portal User ID (if any)
2. For those users not yet assigned a User ID:
 - First name, last name
 - Telephone number
 - Exact name of company, including legal entity type

<p>Mercedes-Benz - Confidential -</p>	<p style="font-size: small;">Schutzvermerk DIN ISO 16016 beachten! /Refer to protection notice DIN ISO 16016! Keine Aenderung ohne Zustimmung der federfuehrenden Konstruktion / Any alterations are subject to the approval of the design department</p> <p style="text-align: center;">Technical Component Requirement Specifications Tail lamp QEV 111 AJPNLG</p>	<p>Bearb./auth.: Hans Peter Schiffert Abt./dep.: RD/KEL Datum/date: 2022-07-25 Requirement Specifications 001 version: Seite/page: 214 of 220</p>
---	---	---

5.4.5.5 Reference Points for Better Evaluation of the Requirements Described Above (STM-2100946)

STM-2100947
STLH-7546

The details provided below are intended to improve the assessment of the requirements and conditions for the IT connection described above. The binding definition of the data specified below shall be agreed upon separately in writing between the client and the contractor, usually following contract award. The client cannot require special IT connection variants and solutions or make definitive binding agreements in this regard in advance. Possible influence on the offer conditions that result from different assumptions on IT connection variants and forms shall be marked in the offer; otherwise, the conditions offered shall apply without restrictions.

STM-867428
STLH-6930

The following IT integration concept forms the basis for the following information:
Connect ID of the connection: 210120_059_106
Version of the IT integration concept:: 01

The following reference points result from the aforementioned IT connection concept:
Protection requirement class to be observed: Internal
Possible network connections: ENX, IP-Sec, MPLS
Bandwidth requirement in Mbit/s per user: 1 Mbit/s

List of applications used via the IT connection to the client's IT landscape: DukeE

5.5 Documentation of Material and Surface Selection (STM-2102104)

STM-2102106
STLH-7551

The material and surface selection shall be recorded in full on the drawing that is stamped by the client or in the 3D data record. In consultation with the component manager responsible, some E/E components such as displays, for example, can be exempted from this obligation. This ensures compatibility between the materials and the surrounding materials, for example.

STM-2102109
STLH-7552

It shall be ensured that the relevant specifications (this also includes standards and regulations) that correspond to the state-of-the-art in science and technology are drawn upon for all materials, join connections and surfaces used. It is not permitted to use the contractor's specifications to meet this target, as the client cannot access their change management.

STM-2102110
STLH-7553

The client shall be entitled to request all development documents and production-related documentation along the supply chain for review and archiving in order to ensure the quality of the component parts and thus the informative value.

5.6 Digital Development (STM-867648)

STM-867650
STLH-3574E

The general requirements for the provision of simulation data are provided under CRQ-572 in the document [\[LHV 310 00x\]](#).

Mercedes-Benz - Confidential -	<small>Schutzvermerk DIN ISO 16016 beachten! /Refer to protection notice DIN ISO 16016! Keine Aenderung ohne Zustimmung der federfuehrenden Konstruktion / Any alterations are subject to the approval of the design department</small>	Bearb./auth.: Hans Peter Schiffert Abt./dep.: RD/KEL Datum/date: 2022-07-25 Requirement Specifications 001 version: Seite/page: 215 of 220
	Technical Component Requirement Specifications Tail lamp QEV 111 AJPNLG	

6

Supplementary Specifications (STM-867651)

Mercedes-Benz - Confidential -	<small>Schutzvermerk DIN ISO 16016 beachten! / Refer to protection notice DIN ISO 16016! Keine Aenderung ohne Zustimmung der federfuehrenden Konstruktion / Any alterations are subject to the approval of the design department</small> Technical Component Requirement Specifications Tail lamp QEV 111 AJPNLG	Bearb./auth.: Hans Peter Schiffert Abt./dep.: RD/KEL Datum/date: 2022-07-25 Requirement Specifications version: 001 Seite/page: 216 of 220
---	--	---

7

List of Abbreviations (STM-867656)

Abbreviation	Description
AVeh	Application vehicle
AV	Implementation regulation
CVeh	Confirmation vehicle
DBL	Daimler-Benz Supply Specification
DS	Identification and documentation of safety relevance
DZ	Identification and documentation of certification relevance, incl. emissions relevance
TVeh.	Test vehicle
FMEA	Failure Mode and Effects Analysis
FV	Function specification
HF	High frequency
HV	High voltage
HW	Hardware
CRS	Component requirement specifications
LIN	Local interconnect network
MBC	Mercedes-Benz Cars
MBN	Mercedes-Benz standard
MDS	Mercedes-Benz Development System
MGU	Other applicable document
PPA	Production Process and Product Approval
STLH	Standard requirement specifications
SW	Software
SWFT	Off-standard-tool parts
VeDoc	Vehicle Documentation Online – Passenger Cars (IT system for Sales)
ZB	Assembly

Mercedes-Benz - Confidential -	<small>Schutzvermerk DIN ISO 16016 beachten! /Refer to protection notice DIN ISO 16016! Keine Aenderung ohne Zustimmung der federfuehrenden Konstruktion / Any alterations are subject to the approval of the design department</small>	Bearb./auth.: Hans Peter Schiffert Abt./dep.: RD/KEL Datum/date: 2022-07-25 Requirement Specifications 001 version: Seite/page: 217 of 220
	Technical Component Requirement Specifications Tail lamp QEV 111 AJPNLG	

8 Normative References (STM-867662)

STM-867658
STLH-331G

The following list contains documents prepared by the client or by external entities. If a version or issue date is cited for a document, then this version shall apply.

If no version or issue date is cited for a document, the following rules apply:

- If the document is an external standard or company standard (namely an [MBN](#) or [DBL](#)), the latest version shall apply in order to ensure that the subject of the standard corresponds to the acknowledged state of the art at the time it is brought to market and following revision of the standard.

- If the document is of another type, that version of the document shall apply that was current at the time of signing of the development contract associated with the component requirement specifications.

Documents produced by the client will be made available to the contractor by the client.

STM-867660
STLH-5449A

The contractor shall check that the referenced standards are up-to-date and take them into account in the tender. Should these standards change during the course of development, the contractor shall reveal the significance of such changes in terms of scheduling and costs.

STM-867659
STLH-2981B

The client's standards and normative references will be made available to the contractor in the Standards Information System (DocMaster).

STM-867661
STLH-2982B

The system can be accessed via the online supplier portal at the following link: <https://supplier-portal.daimler.com/portal/en>

STM-867663
STLH-332B

List of Other Applicable Documents:

DocRef	Titel	Release Date	Version	Basic Number
[A2210002699]	Design Guidelines for Connection Systems	2003-05-03		A2210002699
[ALD00001354]	Ergänzende Anforderungen zur IT-Informationssicherheit im Entwicklungsumfeld	2020-07		ALD00001354
[CADHB]	CAD-Handbuch für produktbeschreibende Daten			CAD-HANDBUCH
[DIN EN 60512-5-1]	Steckverbinder für elektronische Einrichtungen - Mess- und Prüfverfahren - Teil 5-1: Prüfungen der Strombelastbarkeit;			IEC 60512-5-1
[ISO 11898-1]	Road vehicles — Controller area network (CAN) — Part 1: Data link layer and physical signalling			ISO 11898-1
[ISO 16845]	Road vehicles — Controller area network (CAN) conformance test plan — Part 2: High-speed medium access unit — Conformance test plan			ISO 16845
[ISO 26262]	Road vehicles – Functional safety			ISO 26262
[LHV 310 001]	Übergreifende Anforderungen zum Komponentenlastenheft für E/E-, SW- und Mechanik-Umfänge	2021-07	6.9.4	LHV 310 001
[MBN 10284-1]	EMV-Anforderungen – Fahrzeugprüfung			MBN 10284-1
[MBN 10284-2]	EMV-Anforderungen – Komponentenprüfung			MBN 10284-2

Mercedes-Benz - Confidential -	Schutzvermerk DIN ISO 16016 beachten! /Refer to protection notice DIN ISO 16016! Keine Aenderung ohne Zustimmung der federfuehrenden Konstruktion / Any alterations are subject to the approval of the design department	Bearb./auth.: Hans Peter Schiffert Abt./dep.: RD/KEL Datum/date: 2022-07-25 Requirement Specifications 001 version: Seite/page: 218 of 220
	Technical Component Requirement Specifications Tail lamp QEV 111 AJPNLG	

DocRef	Titel	Release Date	Version	Basic Number
[MBN 10317-0]	CAD-Zeichnung / 3D-CAD-Modelle – Kennzeichnung von Merkmalen zur Besonderen Nachweisführung – Grundlagen – Dokumentationspflicht von Bauteilen / Baugruppen			MBN 10317-0
[MBN 10317-2]	CAD-Zeichnung / 3D-CAD-Modelle – Kennzeichnung von Merkmalen zur Besonderen Nachweisführung – Spezifische Vorgaben und Anwendungsfälle (MBC, VAN und Buses)			MBN 10317-2
[MBN 10326]	Elektrische und elektronische Komponenten in Kraftfahrzeugen – Halbleiterbauelemente – Zuverlässigkeitsrelevante Anforderungen			MBN 10326
[MBN 10384-1]	Kfz-Steckverbinder – Prüfmatrix			MBN 10384-1
[MBN 10384-2]	Straßenfahrzeuge – Kfz-Kontaktierungen – Slow-Motion-Prüfung			MBN 10384-2
[MBN 10384-3]	Kfz-Steckverbinder – Prüfabläufe			MBN 10384-3
[MBN 10384]	Kfz-Steckverbinder – Prüfvorschrift			MBN 10384
[MBN 10447]	Qualitätsmanagement-Norm Elektrik / Elektronik für Mercedes-Benz Cars			MBN 10447
[MBN 10463]	MBN Design Rules für E/E-Komponenten			MBN 10463
[MBN 10527-1]	Elektrische und elektronische Komponenten in Kraftfahrzeugen – Halbleiterbauelemente – Allgemeine Qualitätsanforderungen			MBN 10527-1
[MBN 10527-2]	Elektrische und elektronische Komponenten in Kraftfahrzeugen – Halbleiterbauelemente – Spezifische Anforderungen			MBN 10527-2
[MBN 10567]	Elektrische und elektronische Komponenten in Personenkraftwagen bis 3,5t – Allgemeine Anforderungen, Prüfbedingungen und Prüfungen Teil I: Elektrische Anforderungen und Prüfungen 12 V Bordnetz			MBN 10567
[MBN 10599]	Hardware-Deltaqualifikationsmatrix - Qualifikation von Änderungen an elektrischen und elektronischen Komponenten in Kraftfahrzeugen			MBN 10599
[MBN 11012-30]	Geometrische Produktspezifikation (GPS) - Kunststoffteile im Fahrzeugbau - Allgmeintoleranzen			
[MBN LV 112-1]	Elektrische Leitungen für Kraftfahrzeuge; Kupferleitung; einadrig, ungeschirmt			MBN LV 112-1
[MBN LV 215]	Elektrik/Elektronik Anforderungen an HV-Steckverbinder			MBN LV 215
[MBN10435]	Kennzeichnung von Teilen mit Daimler-Warenkennzeichnung und Identmerkmalen			MBN 10435
[MBST]	Mercedes-Benz Special Terms			ALD00000454
[MGU00001711]	Prämisse RD-Hardwarebedarfe	2019-05		MGU00001711
[MSS 20200]	General Networking	2020-01		MSS 20200

Mercedes-Benz - Confidential -	<small>Schutzvermerk DIN ISO 16016 beachten! /Refer to protection notice DIN ISO 16016! Keine Änderung ohne Zustimmung der federführenden Konstruktion / Any alterations are subject to the approval of the design department</small>	Bearb./auth.: Hans Peter Schiffert Abt./dep.: RD/KEL Datum/date: 2022-07-25 Requirement Specifications version: 001 Seite/page: 219 of 220
	Technical Component Requirement Specifications Tail lamp QEV 111 AJPNLG	

DocRef	Titel	Release Date	Version	Basic Number
	Performance Specification			
[MSS 20202]	CAN Networking Performance Specification	2020-10		MSS 20202
[MSS 20220]	Networking Test Suite Requirements	2020-01		MSS 20220
[MSS 30003]	Basic Technology Rollout Plan (BRP)	2021-04	V3.1	MSS 30003
[MSS Powernet V1.0]	Ausführungsvorschrift Bordnetz	2020-01-23		MSS Powernet V1.0
[MTC - SPEZIFIKATION 1/2]	MTC-Spezifikation 1/2	2020-12		MTC - SPEZIFIKATION 1/2
[Anfragezeichnung TK238 MDA]	Anfragezeichnung TK238 MDA			

Mercedes-Benz - Confidential -	<small>Schutzvermerk DIN ISO 16016 beachten! /Refer to protection notice DIN ISO 16016! Keine Aenderung ohne Zustimmung der federfuehrenden Konstruktion / Any alterations are subject to the approval of the design department</small>	Bearb./auth.: Hans Peter Schiffert Abt./dep.: RD/KEL Datum/date: 2022-07-25 Requirement Specifications 001 version: Seite/page: 220 of 220
	Technical Component Requirement Specifications Tail lamp QEV 111 AJPNLG	